



HLP-C⁺ Series

Instruction





ZHEJIANG HOLIP ELECTRONIC TECHNOLOGY CO., LTD.

TEL: 0571-28891071 FAX: 0571-28891072

<http://www.holip.com>

HLP-C⁺ Series

Contents

I. Introduction	1
1.Checks upon Delivery	2
2.Nameplate Information of HLP-C ⁺ Series.....	3
II. Safety Precautions	4
1.Before the Power Up	4
2.During the Power Up.....	6
3.Duing the Operation	6
III. Standard Specifications	8
1.Particular Specifications	8
2.General Specifications	8
IV. Storage and Installation	10
1.Storage.....	10
2.Installation Locationand Environment	10
3.Installation Space and Direction	10
V. Wiring	12
1.Main Circuit Schematic Diagram	12
2.Terminals Description	13
3.Basic Connection Diagram	14
4.Precautions on Wiring	15
VI. Instruction of the digital operator	18
1.Description Of The Digital Operator	18
2.Display Description of Indication Status	18
3.Operation Instruction	19
VII. Commissioning	20
1.Important Checks Before the Commissioning	20
2.Commissioning Methods	20



VIII. Function List	21
IX. Descriptions of Functions	28
X. Care & Maintenance, Fault Information and Troubleshooting	80
1. Precautions about Inspection and Maintenance	80
2. Periodical Inspection and Maintenance items.....	80
3. Fault indication and troubleshooting	81
4. Faults and Analysis	85
XI. Selection of Peripheral Devices and Disposition	88
1. Options	88
2. Disposition	89
XII. Appendices	91
Appendix 1: Application demonstrations	91
Appendix 2: External Appearance and Installation Dimensions	93
Appendix 3: User's Records and Feedback	95

I. Introduction

Thank you for purchasing and using the general-purpose inverter of HLP- C⁺ Series of multi-functions and high performance.

The inverter of HLP- C⁺ Series has been developed on basis of HLP-A Series keeping the main functions of HLP-A Series and with additional functions on request of customers as well as smaller size. So the inverter of HLP- C⁺ Series features more compact and more powerful functions.

Please read carefully the operation manual before put the inverter to use so as to correctly install and operate the inverter, give full play to its functions and ensure the safety. Please keep the operation manual handy for future reference, maintenance, inspection and repair.

Due to the inverter of a kind of electrical and electronic product it must be installed, tested and adjusted with parameters by specialized engineering persons of motor. The marks of  **Danger**  **Caution** and other symbols in the manual remind you of the safety and prevention cautions during the transportation, installation, running and inspection. Please follow these instructions to make sure the safe use of the inverter. In case of any doubt please contact our local agent for consultation. Our professional persons are willing and ready to serve you.

The manual is subject to change without notice.



Danger indicates wrong use may kill or injure people.



Caution indicates wrong use may damage the inverter or mechanical system.



Danger

- Be sure to turn off the input power supply before wiring.
- Do not touch any internal electrical circuit or component when the charging lamp is still on after the AC power supply is disconnected, which means the inverter still has high voltage inside and it is very dangerous.

- Do not check components and signals on the circuit boards.
- Do not disassemble or modify the any internal connecting cord, wiring or component of the inverter by yourself.
- Be sure to make correct ground connection of the earth terminal of the inverter.
- Never remodel it or exchange control boards and components by yourself. It may expose you to an electrical shock or explosion, etc.

**Caution**

- Do not make any voltage withstanding test with any component inside the inverter. These semi-conductor parts are subject to the damage of high voltage.
- Never connect the AC main circuit power supply to output terminals U.V W. of the inverter.
- The main electric circuit boards of CMOS and IC of the inverter are subject to the effect and damage of static electricity. Don't touch the main circuit boards.
- Installation, testing and maintenance must be performed by qualified professional personnel.
- The inverter should be discarded as industrial waste. Avoid burning.

(1) Checks upon Delivery

The inverter has been strictly and well packed before ex-work. In consideration of various factors during the transportation special attention should be paid to the following points before the assembly and installation. If there is anything abnormal please notify the dealer or the relevant people of our company.

- Check if the inverter has got any damage or deformation during the transportation.
- Check if there is one piece of HLP-C⁺ series inverter and one copy of the instruction manual available after unpacking it.
- Check the information on the nameplate to see if the specifications meet your order (Operating voltage and KAV value).

- Check if there is something wrong on the inner parts, wiring and circuit board.
- Check if each terminal is tightly locked and if there is any foreign article inside the inverter.
- Check if the operator buttons are all right.
- Check if the optional components you ordered is contained in it.
- Check if there is a certificate of qualification and a warranty card.

(2) Nameplate Information of HLP-C⁺ Series

MODE:	HLPC ⁺ 01D543B
INPUT:	3PH380V50Hz/60Hz
OUTPUT:	3PH380V4.0A1.5KW
Freq Range:	0.1-600Hz
HLP ELECTRONICS CO., LTD	

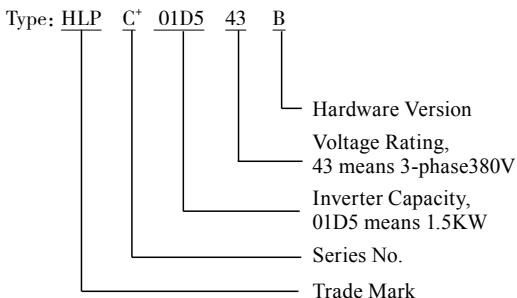

II. Safety Precautions

(1) Before the Power Up



Caution

- Check to be sure that the voltage of the main circuit AC power supply matches the input voltage of the inverter.



Caution

- [E] symbol is the ground terminal. Be sure to make correct ground connection of the earth terminals of the motor and the inverter for safety. E can't be connected to Line zero.
- No contactor should be installed between the power supply and the inverter to use it for starting or stopping of the inverter. Otherwise it will affect the service life of the inverter.



Danger

- R.S.T terminals are power input terminals, never mixed with U.V.W terminals. Be sure that the wiring of the main circuit is correct. Otherwise it will cause damages of the inverter when the power is delivered to it.



Caution

- Do not carry the front cover of the inverter directly when handling, It should be handled with the base to prevent the fall off of the front cover and avoid the dropping of the inverter, which may possibly cause the injuries to people and the damages to the inverter.
- Mount the inverter on a metal or other noncombustible material to avoid the risk of fire.
- Install the inverter in a safe site, avoid high temperature, direct sunlight, humid air or water.
- Keep the inverter from the reach of children or persons not concerned.

- The inverter can only be used at the places accredited by our company. Any unauthorized working environment may have the risks of fire, gas explosion, electric shock and other incidents.
- Install a cooling fan or other cooling device when installing more than one inverters in the same enclosure so that the temperature inside the enclosure be kept below 40°C to avoid overheat or the risk of fire. .
- Be sure to turn off the power supply before dissembling or assembling the operation keyboard and fixing the front cover to avoid bad contact causing faults or non-display of the operator.
- Do not install the inverter in a space with explosive gas to avoid the risk of explosion.

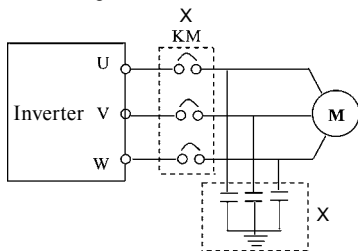

- If the inverter is used at or above 1000m above seal level, the cooling efficiency will be worse, so please run it by changing down.
- Do not install any contactor and other components of related capacitor or varistor on the output side of the inverter. Otherwise it will cause malfunctions and damages of components of the inverter.
- Do not install any switching component like air breaker or contactor on the output side of the inverter. If any of such components must be installed because of process and other needs, it must be ensured that the inverter has no output when the switch takes actions. In addition, it is forbidden to install any for improvement of power factors or varistors against thunder on the output side. Otherwise it

will cause malfunctions, tripping protection and damages of components of the inverter. Please remove them as shown in the above diagram.

- The function of STOP switch is only valid after it is set. Its use is different with the emergency stop switch. Be careful when using it.
- It will affect the service life of the inverter if a contact is connected to the front end of input of the inverter to control its starting and stopping. Generally it is required to control it through FOR or REV terminals. Special attention should be paid to its use in the case of frequent starts and stops.
- Please use an independent power supply for the inverter. Do avoid using the common power supply with an electric welder and other equipment. Otherwise it will cause the protection or damage of the inverter.

(2) During the Power Up



Danger

- Do not plug the connectors (CONNECTOR) of the inverter when it is in the delivery of current to avoid any surge into the main control board due to plugging, which might cause the damage of the inverter.
- Always have the protective cover in place before delivery of current to avoid electrical shock injury.

(3) During the Operation



Danger

- Never connect or disconnect the motor set while the inverter is in running. Otherwise it will cause overcurrent trip and even burn up the main circuit of the inverter.
- Never remove the front cover of the inverter while the inverter is powered on to avoid any injury of electric shock..
- Do not come close to the machine when the fault restart function is used to avoid anything unexpected. The motor may automatically restart after stopping running



Caution

- Do not touch the heat sink, braking resistor, or other heat elements. These can become very hot.
- Be sure that the motor and machine is within the applicable speed ranges before starting operation because the inverter is quite easy to run from lower speed to higher speed.
- Do not check the signals on circuit boards while the inverter is running to avoid danger.
- Be careful when changing the inverter settings. The inverter has been adjusted and set before ex-work. Do not adjust it wantonly. Please make proper adjustments according to the required functions.
- Do consider the vibration, noise and the speed limit of the motor bearings and the mechanical devices when the inverter is running at or above the frequency of 50Hz.

III. Standard Specifications

(1) Particular Specifications

Type	Input Voltage	Power (KW)	Inverter Capacity (KVA)	Output Current (A)	Suitable Motor (KW)
HLPC ⁺ 0D7543B	3φ380V 50/60Hz	0.75	2.2	2.7	0.75
HLP C ⁺ 01D543B		1.5	3.2	4.0	1.5
HLP C ⁺ 02D243B		2.2	4.0	5.0	2.2
HLP C ⁺ 00D423B	Single &	0.4	1.0	2.5	0.4
HLP C ⁺ 0D7523B	Three Phase	0.75	2.0	5.0	0.75
HLP C ⁺ 01D523B	220V 50/60Hz	1.5	2.8	7.0	1.5

(2) General Specifications

Descriptions		HLP- C ⁺
Control Type		SPWM
Input Power		400V class: 345~440V; 230V class: 170~230V
Frequency Control	Range	0.1~600.0Hz
	Accuracy	Digital: 0.01% (-10~40℃) ; Analogue: 0.1% (25±10℃)
	Setting Resolution	Digital: 0.1Hz; Analogue: 1‰ of Max. Operating Frequency
	Output Resolution	0.1Hz
	Operator Setting Method	Press directly Λ or V to set.
	Analog Setting Method	External Voltage 0-5V, 0-10V, 4-20mA, 0-20mA
	Other Functions	Frequency lower limit, starting frequency, stopping frequency, three skip frequencies can be individually set and so on.
Acceleration/Deceleration time Control	Four selectable combinations of independent acceleration and deceleration settings (0.1-6500s).	
V/FCurve	Set V/F curve at will	

General Control	Torque Control	Torque increase settable by max. 10.0%. The starting torque can reach 150% at 1.0Hz.
	Multi-function input terminals	6 multi-input terminals for 8-speed steps control, program operation, switch of 4-steps Accel/Decel, UP/DOWN function, counter, external emergency stop and other functions.
	Multi-function Output terminals	2 multi-function output terminals for the displaying and warning of running, zero speed, counter, external fault, program operation and other information.
	Other Functions	AVR (auto voltage regulation), Deceleration stop or self-stop, DC brake, auto reset and restart, speed search, PLC, traverse function, drawing control, auto energy-savings, carrier adjustable by max. 16KHz, etc.
4-Digits Display & Status Lamp		Display frequency, current, revolution, voltage, counter, temperature, pressure, forward or reserve running, and fault, etc.
Communication Control		RS485
Operation Temperature		-10~40℃
Humidity		0~95% Relative Humidity (without dew)
Vibration		Below 0.5G
Protection Functions	Over Voltage	230V class: DC Voltage > 400V 400V class: DC Voltage > 800V
	Low Voltage	230V class: DC Voltage < 200V 400V class: DC Voltage < 400V
	Instant Stop and Restart	Restarted by speed search after instantaneous stop.
	Stall Prevention	Anti-stall in Acc/Dec Run
	Output End Shorts	Electronic circuit protecting
	Other Functions	Fin over-heat protection, restriction of reverse running, fault reset, parameter lock, etc.

IV.Storage & Installation

(1) Storage

The inverter must be kept in its original package box before installation. Pay attention to the followings when keeping it in storage if the inverter is not used for the time being:

- It must be stored in a dry place without rubbish or dust.
- The suitable temperature for storage is between -20°C and +65°C.
- The relative humidity required is 0-95%, no condensation.
- There is no corrosive gas or liquid in the storage ambience..
- It's better to lay the inverter on a rack and keep it in a proper ipackage.
- It is better not to store the inverter for long time. Long time storage of the inverter will lead to the deterioration of electrolytic capacity. If it needs to be stored for long time be sure to power it one time within a yearand the power on time should be at least above five hours. When powered In input the voltage must be increased slowly with a voltage regulator to the rated voltage value.

(2) Installation Locationand Environment

Attention: The ambient conditions of the inverter will affect its service life.

- Ambient operating temperature -10°C to 40°C with good ventilation.
- No water drop and low moisture.
- Free from direct sunshine, high temperature and heavy dust fall.
- Free from corrosive gas or liquid.
- Less dust, oil gas and metallic particles
- Free from vibration and easy for service and inspection.
- Free from the inteference of electromagnetic noise.

(3) Installation Space and Direction

- There must be enough space left around the inverter for easy maintenance and cooling. See Diagram 1.

- The inverter must be installed vertically and to ensure the smooth ventilation for effective cooling.;
- If there is any instability when installing the inverter, please put a flat board under the inverter bottom base and install again. If the inverter is installed on a loose surface, stress may cause damage in main circuit so as to damage the inverter.
- The inverter should be installed on non-combustible materials, such as iron plates.
- If several inverters are installed together in one cabinet, please add heat dissipation plates and leave enough space between the inverters. See Diagram.

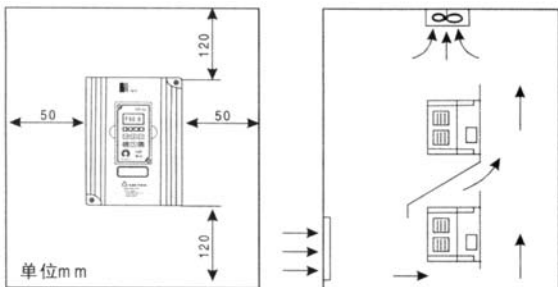

V. Wiring

(1) Main Circuit Schematic Diagram



Power supply: Verify that the inverter's rated voltage coincides with AC power supply voltage to avoid a damage of the inverter.



No fuse breaker: Refer to the related list.

Ground fault circuit interrupter:

Use one of anti-high harmonic.



Magnetic contactor:

Note: Do not use the magnetic contactor as the power supply on/off button for the inverter.



AC reactor: It is recommended to install a AC reactor for power factor improvement if the input capacity is more than 1000KVA.



Inverter:

- Be sure to make correct connections of the main circuit wires and control signal wires of the inverter.
- Be sure to make correct setting of parameters for the inverter.



(2) Function Description of Circuit Terminals

1. Main Circuit Terminals Arrangement

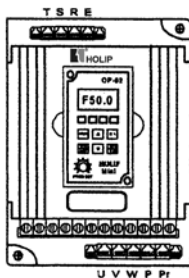

2. Control Circuit Terminals Arrangement

FA	FB	FC	DRV	FOR	REV	RST	SPL	SPM	SPH	GND	AM	VI	AI	+10V
----	----	----	-----	-----	-----	-----	-----	-----	-----	-----	----	----	----	------

3. Function description of main circuit terminals

Symbol	Function Description
R.S.T	Input terminals of AC line power.(230V class, for both single/three phase, single phase connected to any two phases)
U.V.W	Output terminals to motor.
P.P.r	External braking resistor terminals.
E	Ground terminals: the third kind of grounding for 230V and special grounding for 400 V of Electrical Engineering Regulations.

4、Function description of control circuit terminals

Symbol	Function Description	Factory setting
FOR	Multi-function input 1	Forward run
REV	Multi-function input 2	Reverse run
RST	Multi-function input 3	Reset
SPH	Multi-function input 4	High speed
SPM	Multi-function input 5	Intermediate Speed
SPL	Multi-function input 6	Low Speed
GND	Common end for digit control signals	

Symbol	Function Description	Factory setting
+10	Power supply for analog frequency	+10V
VI	Analog frequency reference input (voltage)	0~+10V corresponding to the highest operating frequency
AI	Analog frequency reference input (current)	4~20mA corresponding to the highest operating frequency
DRV	Multi-function output terminal (Optical couple output)	DC24V/100mA
FA FB FC	Multi-function output terminal 3 (N/O or N/C)	3A/250VAC3A/30VDC
AM	Digital frequency output terminal	0-10V
	RS485 communication interface	

Mark: The pin definitions of RS485 communication interface are as follows:

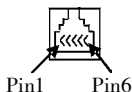

Pin1: GND; Pin2: +5V; Pin3: RS+;
 Pin4: RS-; Pin5: GND; Pin6: GND

(3) Basic Wiring Diagram

The whole wiring of the inverter is divided into two parts, main circuit terminal connections and control circuit terminal connections. Users can see the main circuit terminals, and the control circuit terminals after removing the outer cover. The terminals must be connected correctly as the following wiring circuit diagrams.

The following diagram shows the factory standard connection of Model HLP-C⁺

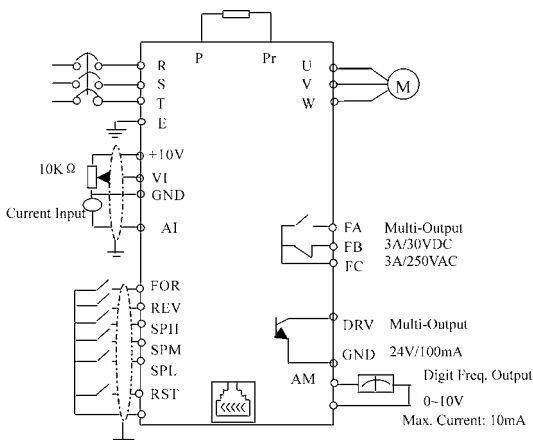

(4) Precautions on Wiring

a: For main circuit wiring:

- While wiring the sizes and specifications of wires should be selected and the wiring should be executed according to the electrical engineering regulations to ensure the safety.
- It is better to use shield wire or wire and tube for power cord and ground the shield layer or two ends of wire tube.
- Be sure to install a No Fuse Breaker (NFB) between the power supply and the input terminals (R.S.T). (If using ground fault circuit interrupter, please choose the one corresponding to high frequency)
- The power line and the control line should be arranged separately and should not be laid in the same ducts..
- Never connect AC power to the output terminals (U.V.W) of the inverter.
- Output wires mustn't be in touch of the metal part of the outer cover, or it will cause earth short-circuit.
- Phase-shifting capacitor, LC, RC noise filters, etc, can never

be connected between the motor and the output terminals (U.V.W) of the inverter.

- The main circuit wire must be enough far away from other control equipments.
- When the wiring between the inverter and the motor exceeds 15 meters for 230V class or 30 meters for 440V class, much higher dV/dT will be produced inside the coil of motor, which will cause the destroy to the interlayer insulation of motor. Please change it to a special AC motor for the inverter or add a reactor on the side of the inverter.
- Please lower the carrier frequency if there is longer distance between the inverter and the motor. Because the higher carrier frequency will result in the bigger leakage current of high-order harmonics of the cables the leakage current will have unfavorable effect on the inverter and other equipment.

Specifications for NFB and Wire

Model	HLPC ⁺ 00 D423B	HLPC ⁺ 0 D7523B	HLPC ⁺ 0 1D523B	HLPC ⁺ 0 2D223B	HLPC ⁺ 0 D7543B	HLPC ⁺ 0 1D543B	HLPC ⁺ 0 2D243B
NFB Capacity	16A	16A	32A	32A	16A	16A	16A
Wire Size	2.5mm ²	2.5mm ²	2.5mm ²	4mm ²	2.5mm ²	2.5mm ²	2.5mm ²
Screw	M4	M4	M4	M4	M4	M4	M4

Note: The parameters above are only for reference, not a standard.

b: For control circuit wiring (signal line)

- The signal line should be separately laid in a different duct with the main circuit wire to avoid any possible interference.
- Please use the shielded cable with the size of 0.5-2mm² for signal lines and make one end grounding. while the shielded cable with the size of 1 mm² is recommended for the control line.
- Use the control terminals correctly according to your needs.

c: Grounding

- Grounding terminal **E**: The third grounding method

(Grounding resistance should be 100. or lower.)

- Choose grounding wires according to the basic length and size of the technical requirements of the electric equipment.
- Do avoid sharing grounding wire with other large power equipment such as electric welder, dynamic machine, etc. The grounding wire should be kept away from the power supply wires.
- The grounding method for several inverters together should be done as the first and second diagrams. Avoid the third diagram.
- The grounding wire must be as shorter as possible.
- Please make correct grounding in the earthing terminal area. Never connect it to zero line.



(1) Good

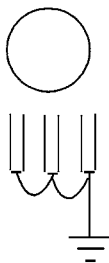

(2) Good

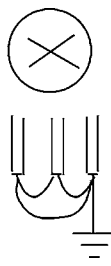

(3) Not good

VI. Description of Digital Operator

(1) Description of Digital Operator

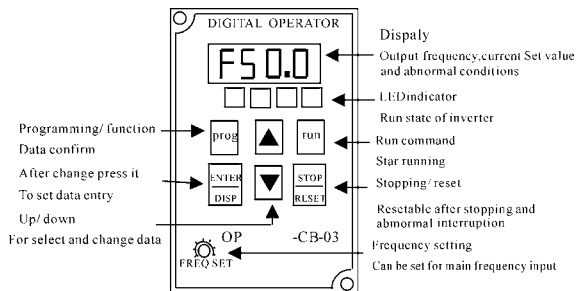

(2) Display Status

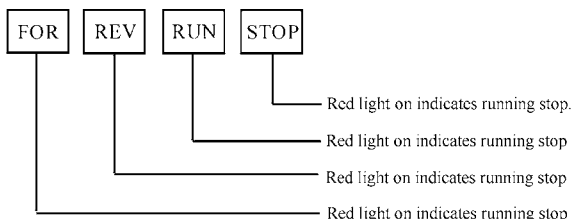

1. During stopping: STOP on.

2. During operation

a: In case of output, RUN on, STOP dark; in case of forward rotating, FWD on, in case of reverse rotating, REV on.

b: Run → Stop, then RUN on, STOP flashing → RUN dark, STOP on.

c: Forward → Reverse, then FWD on, REV flashing → FWD flashing, REV on.

d: When the inverter is operated in 0.00HZ, RUN flashing and STOP off.

e: In jogging, RUN on, STOP flashing.

(3) Operation instruction

A. Description: Displaying Contents

1、	50.0	Output Frequency 50.0Hz
2、	F50.0	Set Frequency 50.0Hz
3、	A02.0	Output Current 2.0A
4、	U22.0	Output Voltage 220V
5、	U54.0	DC Voltage 540V
6、	39.0	Temperature 39°C
7、	0001	Counter
8、	L50.0	PID feedback is 50%
9、	000.0	Revolution
10、	F□□	Forward Moving
11、	rE□	Reverse Moving

B. DC voltage, the temperature, counter, PID feedback and revolution can only be displayed after setting. For specific parameter refer to C121.

C. Show the interface content before power off at power on

D. Under the status of FOR, REV, CXXX and parameter content, it can automatically return to the interfaces of frequency, voltage, electric current, etc. automatically after several seconds.

E. Under the status of Running and Stopping, it continues to display the original interface. But the corresponding contents will change with the running situation and the indicator lamp will indicate the corresponding status. During the operation the fan is running and when stopping the fan stops running.

VII. Commissioning

(1) Important Checks Before the Commissioning

- If there is any wrong connected wires? Pay special attention to the terminals: U.V.W; Make sure the power supply wires are connected to R.S.T, not U.V.W.
- If there is any metal powder or other wires left on the base plate of the inverter or at the terminals, which might cause short circuit.
- If the screws are tightly locked and if the connecting parts are loose.
- If there is any short circuit or earth fault in the output parts.

(2) Commissioning Methods

The procedure of the operator is factory set up for the control method of HLP series. The commissioning can be carried out through the digital operator. Generally, the commissioning can be conducted at 5.00 Hz.

Procedures	Display	Indicator Lamp
POWER ON	F000	FOR, STOP on
Press \triangle	00.00	FOR, STOP on
Press \triangle	05.00	FOR, STOP on
Press RUN	F05.0	FOR, RUN on. The fan operates.
Press STOP	F05.0	FOR, STOP on. The fan stops.

Note: The fan runs when the inverter is operating or the temperature is reached within the inverter. In the process the inverter shuts down with the operation frequency dropping to 0.00HZ, STOP indicator lamp glimmer and will be on when the inverter stops.

VIII. Function List

Parameter and Function List (Part 1)

Function code	Function	Set Range & Function Explanation	Factory Setting
C000	Main frequency	0.0~600.0Hz	0.00
C001	Accel. Time	0.1~6500S	5.0
C002	Decel. Time	0.1~6500S	5.0
C003	V/F Curve	0~16	00
C004	Max. voltage	0.1~255/510	220/380
C005	Base frequency	0.01~600	50/60
C006	Intermediate voltage	0.1~255/510	*
C007	Intermediate frequency	0.01~600	*
C008	Min. voltage	0.1~*	*
C009	Min. frequency	0.1~20.0Hz	*
C010	Max. frequency	10.0~600.0	50.00
C011	Frequency lower limit	0.0~600	0.00
C012	Running control	0~2	0
C013	Running frequency select	0~2	0
C014	Starting mode select	0~1	0
C015	Stopping mode	0~1	0
C016	FOR/REV select	0~1	1
C017	STOP key select	0~1	1
C018	S-Curve Time	0~6500S	0
C019	Carrier frequency	0~15	09
C020	Starting Frequency	0.1~10	1.5
C021	Stopping Frequency	0.1~10	1.5
C022	Jog Frequency	0~600	5.0
C023	Jog Accel/Decel Time	0.1~25.0	1.0

Parameter and Function List (Part 2)

Function code	Function	Set Range & Function Explanation	Factory Setting
C024	PLC operation	0~5	0
C025	Auto PLC operation	0~3	0
C026	PLC rotation Direction	0~255	0
C027	PLC Accel/Decel Time 1	0~255	0
C028	PLC Accel/Decel Time 2	0~255	0
C029	Accel. Time 2	0.1~6500S	10.0
C030	Decel. Time 2	0.1~6500S	10.0
C031	Accel. Time 3	0.1~6500S	50.0
C032	Decel. Time 3	0.1~6500S	50.0
C033	Accel. Time 4	0.1~6500S	100.0
C034	Decel. Time 4	0.1~6500S	100.0
C035	Frequency 2	0.0~600.0Hz	15.0
C036	Frequency 3	0.0~600.0Hz	20.0
C037	Frequency 4	0.0~600.0Hz	25.0
C038	Frequency 5	0.0~600.0Hz	30.0
C039	Frequency 6	0.0~600.0Hz	35.0
C040	Frequency 7	0.0~600.0Hz	40.0
C041	Frequency 8	0.0~6500S	0.50
C042	PLC Timer 1	0.0~6500S	10.0
C043	PLC Timer 2	0.0~6500S	10.0
C044	PLC Timer 3	0.0~6500S	0.0
C045	PLC Timer 4	0.0~6500S	0.0
C046	PLC Timer 5	0.0~6500S	0.0
C047	PLC Timer 6	0.0~6500S	0.0
C048	PLC Timer 7	0.0~6500S	0.0
C049	PLC Timer 8	0.0~6500S	0.0

Parameter and Function List (Part 3)

Function code	Function	Set Range & Function Explanation	Factory Setting
C050	Multi-input FOR	0: Invalid; 1:Run; 3:	02
C051	Multi-input REV	For. rotation; 4: Rev.	03
C052	Multi-input RST	rotation; 5: Stop; 5:	10
C053	Multi-input SPH	For/Rev.; 6: Jog; 7: Jog	17
C054	Multi-input SPM	For rotation; 8: Jog Rev	18
C055	Multi-input SPL	Rotation; 9: Emergency stop; 10: Reset; 12: Overheat of radiator or motor; 13: Timer 1 start; 14: Timer 2 start; 17: High speed; 18: Intermediate speed; 19: Low speed; 20: Multi-Speed 1; 21: Multi-Speed 2; 22: Multi-Speed 3; 23: Accel/Decel select 1; 24: Accel/Decel select 2; 25: UP function; DOWN function; 27: Counter pulse; 28: Counter reset; 29: Drawing start; 31: Auto PLC Reset suspend; 32: PID valid	19

Parameter and Function List (Part 4)

Function code	Function	Set Range & Function Explanation	Factory Setting
C056	Multi-output DRV	0: Invalid; 1: Run; 2: Fault Signal; 3: Zero Speed; 4: DC Braking indication; 5: Set Frequency reach; 6: Uniform Frequency 1 reach; 7: Uniform Frequency 2 reach; 8: In Accel.; 9: In Decel.; 10: Inverter Overload alarm; 11: Motor Overload alarm; 12: Overtorque detect; 13: Undervoltage alarm; 14: Single stage end; 15: Process end; 16: Set Counter reach; 17: Intermediate Counter reach; 18: Externally controlled Timer 1 reach; 19: Externally controlled Timer 2 reach; 20 4~20mA disconnected; 27: Drawing reach; 28: PID Down Limit alarm; 29: PID Up Limit alarm; 30: Fan run; 31: Electromagnetic Relay act; 32: Braking Resistor act	01
C057	Multi-output FABC		02
C058	Multi-Analog AM	0~7	0
C059	Analog output gain	0~100	100
C060	Up/down mode	0~1	0
C061	Reserved		

Parameter and Function List (Part 5)

Function code	Function	Set Range & Function Explanation	Factory Setting
C062	Timer 1 time	0.0~10.0	00.0
C063	Timer 2 time	0~100	000
C064	Counter	0~9999	0
C065	Intermediate Counter	0~9999	0
C066	Skip Frequency 1	0~600	0.0
C067	Skip Frequency 2	0~600	00.00
C068	Skip Frequency 3	0~600	0.0
C069	Skip Frequency range	0.1~10.00	0.50
C070	Uniform Frequency 1	0.0~600	00.00
C071	Uniform Frequency 2	0.0~600	00.00
C072	Analog Quantity Select	0~4	0
C073	Low end frequency of analog quantity	0.0~600	00.00
C074	Bias direction of low end frequency	0~1	0
C075	High end frequency of analog quantity	0.0~600	51.0
C076	Bias direction of high end frequency	0~1	0
C077	Negative bias reverse	0~1	0
C078	Analog Filtering Constant	0~50	20
C079	Overvoltage stall prevention	0~1	1
C080	Stall prevention level during accel.	0~200	150
C081	Stall prevention level during running	0~200	000

Parameter and Function List (Part 6)

Function code	Function	Set Range & Function Explanation	Factory Setting
C082	Stall prevention level during decel.	0~200	180
C083	Overtorque detect level	0~200	000
C084	Overtorque detect time	0.1~20.0	01.0
C085	Rated Motor Voltage	*	220/380
C086	Rated Motor Current	*	*
C087	Motor poles	02~60	04
C088	Rated Motor Revolution	0~9999	1440
C089	Motor no-load current	0~100	40
C090	Slip compensation	0~1.0	0.000
C091	DC braking voltage	0.0~20.0	2.0
C092	DC braking time at starting	0.0~25.0	0.0
C093	DC braking time at stopping	0.0~25.0	0.0
C094	Speed search time	0.0~20.0	5.0
C095	Speed search current level	0~200	150
C096	Restart after instantaneous stop	0~1	0
C097	Allowable power-off time	0.1~5.0	0.5
C098	Number of abnormal restart	00~10	00
C099	Auto voltage regulation function	0:Invalid 1: Effective	1
C100	Auto torque compensation	0.0~10.0	2.0

Parameter and Function List (Part 7)

Function code	Function	Set Range & Function Explanation	Factory Setting
C101	Auto Energy Saving	0.0~20.0	0.0
C102	PID P value	0~1000	100.0
C103	PID I value	0.0~3600	5.0
C104	PID D value	0.01~10	0.00
C105	PID target value	0.0~100	0.0
C106	PID target value	0~1	0
C107	PID up limit	0~100	100
C108	PID down limit	0~100	000
C109	Communication addresses	0~250	000
C110	Baud rate of communication	0~3	1
C111	Communication agreement	0~7	0
C120	Parameter lock	0~1	0
C121	Display contents	0~255	00
C122	Inverter model	*	*
C123	Rated inverter voltage	Set up by type	*
C124	Rated inverter current	Set up by type	*
C125	Countries	0~1	0/1
C126	Manufacture date	Year: Month: Week	*
C127	Serial No.	*	*
C128	Fault reset and clear	00~8	00
C129	Voltage up time during Speed search	0.1~10.0	0.5
C130	Stall & decel time during running	0.1~25.5	2.5
C131	Fault reset time	0.2~25.0	1.0
C132	Counter memory for power-off	0~1	0
C133	Drawing memory function	0~1	0

IX. Description of Functions

C000 Main Frequency

Set Range: 0.00~600.0Hz Unit: 0.01 Factory Setting: 0.00

In the digital operator method, the inverter will run at the setting value of C000. During running, the running frequency can be changed by pressing the ▲ or ▼ key. During multi-speed running, the main frequency is the first speed step frequency. In the external terminals method, if C013 is set to 1, i.e. the running frequency is given by the potentiometer. The first speed step is given by the potentiometer of the panel or external potentiometer. Concrete conditions can be selected by jump wires of CN1.

The setting of main frequency is limited by the max. operation frequency.

C001 Accel. Time

Set Range: 0.1~6500.0S Unit: 0.1S Factory Setting: 5.0

C002 Decel. Time

Set Range: 0.1~6500.0S Unit: 0.1S Factory Setting: 5.0

Accelerating Time means the time needed for the inverter frequency from 0Hz to 50Hz(See t1 in the diagram). Decelerating Time means time needed for inverter frequency from 50Hz to 0Hz(See t2 in the diagram)

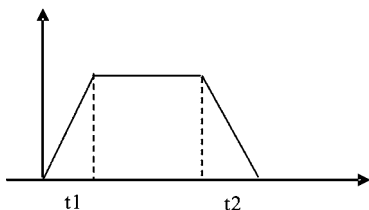

HLP-C⁺ Series inverter have 4 Accel/Decel Times. For Accel/Decel Time 2.3.4 the different accelerating and decelerating

time can be selected through the external terminals and by switching of Accel/Decel Time according to actual needs. In the internal control multi-speed running, different Accel/Decel time can be selected through simple PLC.

C003 V/F Curve

Set Range: 0~16

Unit: 1

Factory Setting: 00

0: Wanton curve

1~16: 16 curves are wanton and available.

When C003 is set to 0, the curve can be written wantonly by the customer.

When C003 is set to 1~16, there are 16 curves for choice.

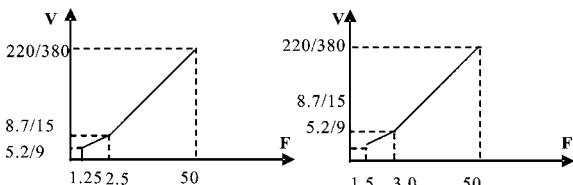

(1)

(2)

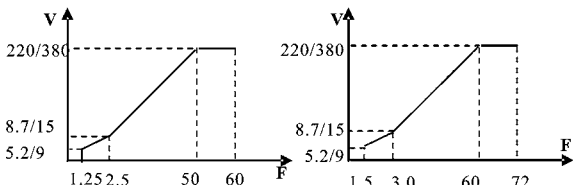

(3)

(4)

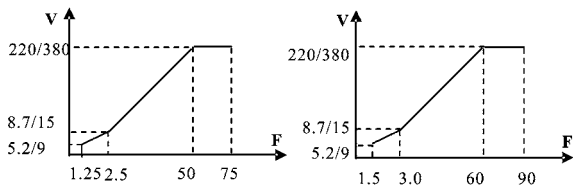

(5)

(6)

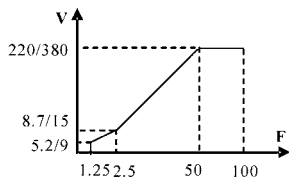

(7)

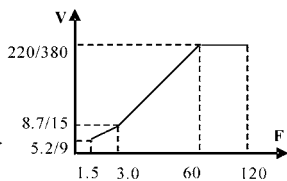

(8)

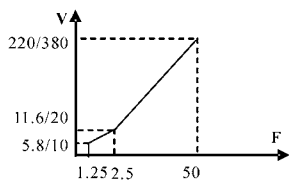

(9)

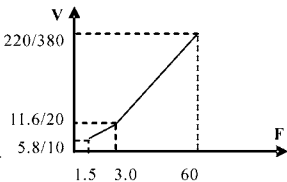

(10)

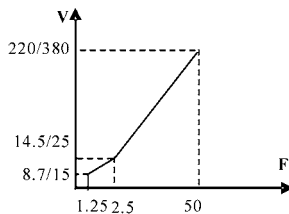

(11)

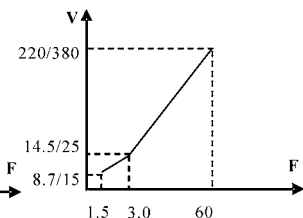

(12)

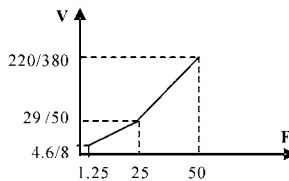

(13)

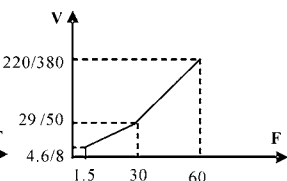

(14)

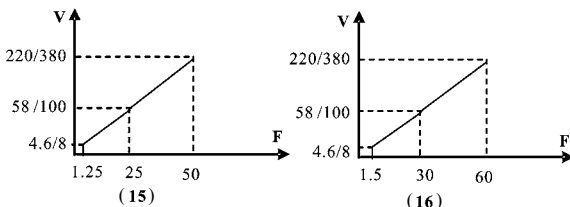

Given values for the inverter of 230V/400V class:

Use	C003	C010	C005	C007	C009	C006	C008	Remarks
Constant Torque	1	50	50	2.5	1.25	8.6/15	5.2/9	→
	2	60	60	3.0	1.5	8.6/15	5.2/9	
	3	60	50	2.5	1.25	8.6/15	5.2/9	
	4	72	60	3.0	1.5	8.6/15	5.2/9	
	5	75	50	2.5	1.25	8.6/15	5.2/9	
	6	90	60	3.0	1.5	8.6/15	5.2/9	
	7	100	50	2.5	1.25	8.6/15	5.2/9	
	8	120	60	3.0	1.5	8.6/15	5.2/9	
Start High	9	50	50	2.5	1.25	11.5/19.9	5.7/9.9	
	10	60	60	3.0	1.5	11.5/19.9	5.7/9.9	
	11	50	50	2.5	1.25	14.4/25	8.6/15	
	12	60	60	3.0	1.5	14.4/25	8.6/15	
Fan Model	13	50	50	25	1.25	28.9/50	4.6/7.9	
	14	60	60	30	1.5	28.9/50	4.6/7.9	
	15	50	50	25	1.25	57.9/100	4.6/7.9	
	16	60	60	30	1.5	57.9/100	4.6/7.9	

While restoring the factory settings, default of Curve 1 or 2 is related to the setting value of C125. When C125 is set to 0, the factory value is restored and the default of C003 is 1, while C125 is set to 1, the factory value is restored and the default of C003 is 2. The relevant parameters refer to the explanation of C125.

After the determination of 16 curves, C004, C005, C006, C007, C008, C009 still can be adjusted and set. C016 is for checking the setting.

C004 Max. Voltage		
Set Range: 0.1~255/510V	Unit: 0.1V	Factory Setting: 220/380

C005 Base Frequency		
Set Range: 0.01~600.00Hz	Unit: 0.1Hz	Factory Setting: 50.00/60.00

C006 Intermediate voltage		
Set Range: 0.1~255/510V	Unit: 0.1V	Factory Setting: *

This parameter can set any intermediate voltage in the V/F curve. If it is set improperly, it will cause motor over current or deficit torque, or even an inverter tripping.

This set value is limited by the max voltage value.

C007 Intermediate Frequency		
Set Range: 0.01~600.00Hz	Unit: 0.01Hz	Factory Setting: *

This parameter can set any intermediate frequency in the V/F curve. If it is set improperly, it will cause motor over current or deficit torque, or even an inverter tripping.

This set value is limited by the setting of base frequency.

C008 Voltage at Lower Frequency		
Set Range:0.1~*	Unit:0.1V	Factory Setting:*

This parameter can set the lowest starting voltage in the V/F curve.

This setting value is limited by the voltage at the highest operating frequency.

C009 Min. Frequency		
Set Range:0.1~20.00Hz	Unit:0.01Hz	Factory Setting:*

This parameter sets the lowest starting frequency in the V/F curve.

C010 Highest Running Frequency		
Set Range:10.0~600.0Hz	Unit:0.01Hz	Factory Setting: 50.00/60.00

This parameter sets the highest operating frequency of the inverter.

The settings of C006, C007, C008 and C009 are related to the setting value of C125. When C125 is set as 0, the factory setting is the first V/F curve, while C125 is set as 1, the factory setting is the second V/F curve. When restoring the factory setting the memorized contents are as above.

Note: ★ means uncertain values or various setting values.

C011 Frequency Lower Limit		
Set Range : 0.0~600.0	Unit : 0.1Hz	Factory Setting : 0.00

This is set for preventing workers from false operation, avoiding overheat or some other mechanical faults, which might be caused due to the too low running frequency. When the setup frequency is below the lower limit the inverter is running at frequency lower limit.

This set value is limited by frequency upper limit.

C012 Control Mode		
Set Range : 0~2	Unit : 1	Factory Setting : 0

0: Control by the digital operator. The running command is given through the digital operator.

1: Control by external terminals. The running command is given through external terminals (multi-function input terminals).

2: Control by the communication ports. The running command is given through communication ports.

C013 Running Frequency		
Select Set Range : 0~2	Unit : 1	Factory Setting : 0

0: Set by digital operator.

The running frequency is given through the digital operator.

1: Set by potentiometer.

The running frequency is controlled by the analog signal through external terminals or potentiometer of the panel. Relate to CNI state.

CNI State					
1	2	3	1	2	3
○	○	○	○	○	○
Potentiometers of the panel			Analog quantities of external terminals		

2 : Set by the communication ports.

The running frequency is given through the serial communication ports.

C014 Starting Mode Select		
Set Range : 0~1	Unit : 1	Factory Setting : 0

Two starting modes are available for different equipment.

0 : Start from the starting frequency.

When C092 is set as 0, i.e. DC brake is invalid when starting, it starts running from its starting frequency. When C092 is set to any non zero value, i.e. DC brake is valid when starting, it will first have a DC braking when starting, and then start from the starting frequency.

Related parameters refer to C091 and C092.

1 : Starting by Speed Search

This function can be used in the restarting of large inertia load. When restarting, the inverter will trace the former speed from the set frequency downward. In case of large inertia equipment, when restarting, it can implement the running command right away without waiting for the complete stop of the equipment by tracking the former frequency to save time.

Note: When the inverter is restarted by speed search, it will start tracking the frequency from its set frequency downward, and search it at the highest speed. When starting, the current will be high, and over current or stall may occur. Be sure to pay attention to the adjustment of current standard position of speed search. Generally, C095 should be set around 100%. The concrete value should be specifically set according to the characteristics of mechanical load.

C015 Stopping Mode		
Set Range : 0~1	Unit : 1	Factory Setting : 0

Two stopping modes are available for the requirements of different equipment.

0 : Decelerate to stop

When C093 is set as 0, DC braking is invalid. When DC braking is invalid, the inverter will decelerate to the stopping frequency, and then stop toutput, and the motor will have a free running to a final stop. When C093 is set for any non-zero value 0, the DC braking is valid, and the inverter will first decelerate to the stopping frequency, and then stop finally by DC braking.

When stopping, the DC braking is usually used in high position stopping or for position control. Be sure to notice that frequent uses of DC braking will cause the motor overheat.

Related parameters refer to C091 and C093.

1 : Free-running Stop

When the inverter receives a STOP command, it will immediately stop output and the motor will have a free running till a stop. When the free-running stopping mode is selected for the motor, DC braking is invalid.

C016 For/Rev Rotation		
Select Set Range:0~1	Unit:1	Factory Setting:1

0:Reverse Run is forbidden.

1:Reverse Run is allowed.

This function is suitable for the motor, which cannot have reverse rotation, to prevent workers from false operation. When the reverse rotation is forbidden, the motor can only rotate forward, and cannot have reverse rotation.

When the reverse rotation is forbidden, if switching between For/Rev rotation on the panel, the panel will show Rev Run, but the motor is actually making forward rotation with the indicator lamp indicating For Run.

C017 STOP key Select		
Set Range:0~1	Unit:1	Factory Setting:1

0:STOP is invalid.

1:STOP is valid.

This parameter set is only valid when C012 is set as 1 or 2.

When the control method is set for external terminals or communications, the STOP key on the panel can be chosen to be valid or not. When choosing it as valid, the STOP key can stop the inverter in running. When it needs restarting, the former running signal should be released first and then restarting is allowable.

C018 S-Curve Time		
Set Range:0~6500S	Unit:1	Factory Setting:0

This parameter can be set for no impact slow start or slow stop of the inverter when starting or stopping. When starting S-curve the inverter will make accel or decel curve of different speed rates according to Accel/Decel Time.

When C018 is set to 0, S-curve is invalid, i.e. accelerate or decelerate in straight line. Without consideration of stall the actual Accel/Decel Time is equal to the set Accl/Decel Time plus S-curve Time.

C019 Carrier frequency (Note:0 ~ 15 corresponding to 0 ~ 16K Hz)		
Set Range:0~15	Unit:01	Factory Setting:09

The carrier frequency has some affect on the electromagnetic noise of the motor, and meanwhile the level of the carrier frequency has certain relation with the heating capacity of the inverter and the interference to the environment.

See the following table:

Carrier Frequency	Electromagnetic Noise	Heating Capacity	Interference to the Environment
Low ↓	High ↓	Small ↓	Little ↓
High	Low	Large	Great

Carrier frequency corresponding table:

Set Value	0	1	2	3	4	5	6	7	8	9	10	11	12	13	14	15
Carrier Frequency KHz	1.5	2	3	4	5	6	7	8	9	10	11	12	13	14	15	16

As shown in the table above, with a higher carrier frequency, the electromagnetic noise will be lower, but the interference to other systems must be prevented. With a lower carrier frequency, the electromagnetic noise will be a little higher, but the heating capacity will be small. So the carrier frequency should be set as low as possible, especially with large power machines, if the noise demand is not so high.

C020 Starting Frequency

Set Range : 0.1~10.0Hz Unit : 0.1Hz Factory Setting : 1.5

Starting frequency is the initial frequency when the inverter is started. If the starting frequency is set to 4.0Hz, the inverter will begin to run at 4.0Hz, and later on run between 4.0 ~ 600Hz .

C021 Stopping Frequency

Set Range : 0.1~10.0Hz Unit : 0.1Hz Factory Setting : 1.5

When the inverter receives a stop command, it will immediately decelerate to the stopping frequency, stop output or start DC brake to a final stop.

If C093 is set to 0, DC brake is invalid when stopping and the inverter will stop output.

If C093 is set to any other parameter except “0”, DC brake is valid; the inverter will stop by DC braking.

C022 Jog Frequency

Set Range : 0.0~600.0 Unit : 0.1 Factory Setting : 5.0

The parameter set can realize the jogging function when the inverter is tested. The jog operation can be achieved only through the external terminals, which can be set by multi-function input terminals. Jog frequency is limited by the lower/upper limit of the frequency. While the jog function is implemented, other run commands are invalid. The accelerate

time of jog frequency is set by C023. Jog stopping mode is the same as the normal run stopping mode, which can be set by C15. This function is only valid at stop condition. It is invalid at running. When C012 is set to 1, it is valid.

C023 Jog Accel/Decel Time		
Set Range : 0.1~25.0	Unit : 0.1	Factory Setting : 1.0

The set value of Jog Accel/Decel Time responds to Accel/Decel Time of 0~50Hz.

C024 PLC Operation	
Set Range : 0~5	Factory Setting : 0

0: Normal operation, i.e. the inverter is running by the normal control method.

1: External control 4- Speed Steps

In the external control 4-Speed Steps the disturbance function can be used at intermediate speed. Then C41 (Frequency 8) is the disturbance amplitude. If it is equal to zero this function is invalid. C042 Time 1 and C043 Time 2 are disturbance time. Detail descriptions refer to the function description and diagram of three terminals of high, intermediate and low speed C050~C055.

2: External control multi- speeds

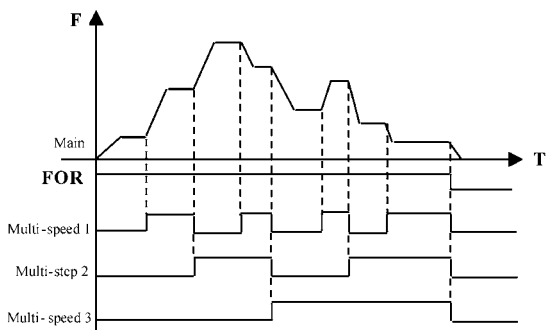

Multi-function Terminals			Results
Multi-speed 1	Multi-speed 2	Multi-speed 3	
OFF	OFF	OFF	Main frequency and frequency are determined by C000 or potentiometer.
ON	OFF	OFF	Multi-speed 1 and frequency are determined by C035.
OFF	ON	OFF	Multi-speed 2 and frequency are determined by C036.
ON	ON	OFF	Multi-speed 3 and frequency are determined by C0375.
OFF	OFF	ON	Multi-speed 4 and frequency are determined by C038.
ON	OFF	ON	Multi-speed 5 and frequency are determined by C039.
OFF	ON	ON	Multi-speed 6 and frequency are determined by C040.
ON	ON	ON	Multi-speed 7 and frequency are determined by C041.

Note:

- (1) To realize External control 8-Speed Steps it is only valid when Multi-input is set for Multi-speed 1, 2, 3 and C024 is set to 2.
- (2) By using Multi-speed 1, 2, 3 they can make up 7- Speed Steps. Adding the main frequency it will compose the setting of 8-Speed Steps.
- (3) The frequencies of Step 1 ~ Step 7 are determined by C035~C41.
- (4) Each Accel/Decel Time is determined by the external multi-function terminal.
- (5) The directions of each program running are determined by the external multi-function terminals.
- (6) The main frequency can be given in two ways. One method is to set it by C000 and another is to set it by the potentiometer. When C013 is set to 1 the frequency of Main Frequency is given by the potentiometer of the panel or external analog quantity.
- (7) The common use of Multi-speed and analog quantity is only

valid in the external control multi-speed. It is invalid in the external control 4- speeds.

3: Disturbance (Traverse function)

This is a special parameter in the chemical fiber and printing and dyeing industries to realize the traverse function. Except the commands of stop, external faults and emergency stop all other commands will not be accepted at running.

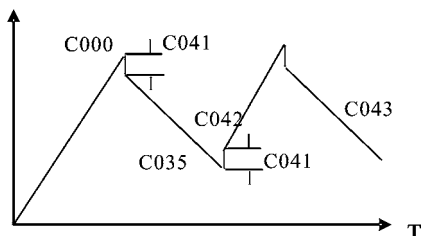

Note:

- (1) The frequency at each inflection point is determined by C000 and C035.
- (2) Skip Frequency is determined by C041.
- (3) Running Time is determined by Timer C042 and C043.
- (4) Restart after power off. The running status of frequency will not be memorized.

4: Internal control Multi-speed

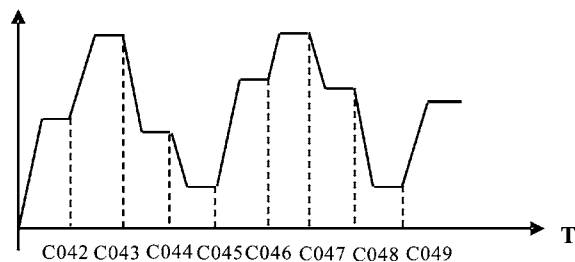

Note:

- (1) Main speed and 7-speeds composes 8-speeds.

(2) Accel/Decel Time of each speed is set by PLC Accel/Decel Time C027 and C028. Refer to the detail descriptions of C027 and C028.

(3) Running Time is set by Timer C042~C049. For the control step not used the timer can be set to 0.

(4) Running direction of each speed is determined by C026.

(5) In the internal control multi-speed running the running time and direction are determined by the setting of internal parameters. Any external switch of time and For/Rev rotation is invalid.

(6) Restart after power off. It will restart from the main speed. The status before the power off will not be memorized.

5:Drawing

This is a special parameter for the constant speed of unwinding and rewinding. By using this function the linear speed constance within a certain accuracy can be realized.

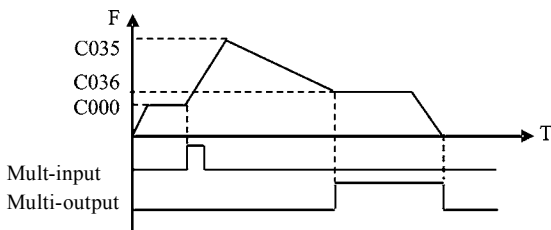

Note:

(1) Through the trigger of the external multi-function terminal the drawing action begins to be implemented.

(2) In implementation of drawing the actual running time is $T=C042 \times 10$;

(3) when the drawing is finished the inverter will have output of C036 at the constant speed and the corresponding multi-output contact will act. Until receiving the Stop command the inverter will stop running and the multi-output contact will reset.

(4) In case of C133=1, it has the memory function of power off. When it restarts after the power off the prior status will be memorized.

(5) The output frequency for drawing can be either up or down.

C025 Auto PLC Operation

Set Range : 0~3

Factory Setting : 0

0 : Stop after the program runs for onw week.

1 : Cycling Running.

2 : Stop after it runs automatically for one week (Stop for intervention) .

3 : Auto running (Stop for intervention) and recycling operation.

Note: This parameter set is only valid when C024 is set to 4. For relevant parameters refer to C000, C024, C035~C049.

0 : Stop after the program runs for onw week.

When the command of auto program running is given the inverter start to operate with the setting of internal parameters. It stops automatically after running for one week. Only with another running cammand given the inverter can restart.

1 : Cycling Running.

When the running command is given the inverter start to operate in sequence with the section speed frequency and running time set by each internal parameter and recycled. During the recycling operation, except the commands of stop, external faults and emergency stop, all other commands will not be accepted.

2 : Stop after it runs automatically for one week (Stop for intervention)

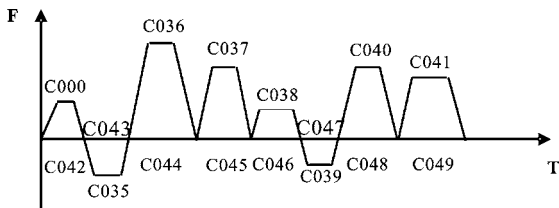

Note:

(1) Whhen the command of automatic program running is given

the inverter will operate according to each parameter, but it will stop first and then restart at the change of each stage. It will stop automatically after running for onw week. Only with another running cammand given the inverter can restart.

(2) The frequencies of each speed step are set by C000, C035~C041.

(3) The running times of each speed step are set by C042~C049.

(4) The running direction is set by C026.

3:Auto running (Stop for intervention) and recycling operation.

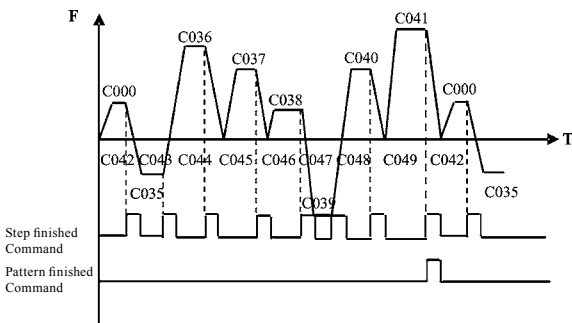

Note:

(1) After the auto pattern run command is given the inverter will run according to the parameters, but at every change of step it will stop first and then start again. It will continue and stop until the OFF command for auto run is given.

(2) When each step is finished the corresponding multi-function output contac will act.

(3) When each pattern run is finished the corresponding multi-function output contac will act.

(4) The width of output pulse is 20 ms.

(5) When running again after power off all the actions will be started from the beginning and the previous states will not be memorized.

C026 PLC Rotation Direction

Set Range:0~255

Factory Setting:0

This parameter is only valid when C024 is set to 4.

The setting of this parameter determines the rotation directions of each frequency step of C035~C041 and C000 in the pattern run. The setting method is as follows:

The rotation direction is set first in the binary bit mode, and then converted to a decimal value for the setting of this parameter. For instance:

bit 0-7

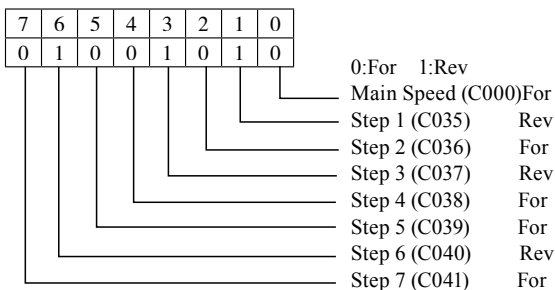

The parameter value 01001010 is converted to a decimal value:

$$1 \times 2^6 + 1 \times 2^3 + 1 \times 2^1 = 64 + 8 + 2 = 74$$

Then C026=74

C027 PLC Accel. / Decel. Time 1

Set Range:0~255

Factory Setting:0

This parameter is only valid when C024 is set to 4.

This parameter is set to determine the accel/decel time values of Step 1~4 of the internally controlled multi-speed. Its setting method is as follows:

(1) Determine each accel/decel time in in the binary 2 bit mode

Bit1	Bit2	Accel/Decel Time
0	0	Accel/Decel Time 1: C001, C002
0	1	Accel/Decel Time 2: C029, C030
1	0	Accel/Decel Time3: C031, C032
1	1	Accel/Decel Time 4: C033, C034

(2) Determine the accel/decel time of each speed step in in the binary 8 bit mode

Speed No. 4		Speed No. 3		Speed No. 2		Speed No. 1	
t4		t3		t2		t1	
0	1	1	0	0	0	1	1

t1 Select Accel. Time 4

t2 Select Accel. Time 1

t3 Select Accel. Time 3

t4 Select Accel. Time 2

The setting value: $1 \times 2^0 + 1 \times 2^1 + 1 \times 2^5 + 1 \times 2^6 = 99$, So C027 is set to 99.

Attach: $2^0 = 1 + 2^1 = 2$, $2^2 = 4$, $2^3 = 8$, $2^4 = 16$, $2^5 = 32$, $2^6 = 64$

C028 PLC Accel. / Decel. Time 2

Set Range: 0~255

Factory Setting: 0

This parameter is set to determine the accel/decel time of Step 5~8 of the internally controlled multi-speed. Its setting method is the same as C026 and C027. Details refer to the description of C027.

C029 Accel. Time 2

Set Range: 0.1~6500S

Unit: 0.1S

Factory Setting: 10.0

C030 Decel. Time 2

Set Range: 0.1~6500S

Unit: 0.1S

Factory Setting: 10.0

C031 Accel. Time 3

Set Range: 0.1~6500S

Unit: 0.1S

Factory Setting: 50.0

C032 Decel. Time 3

Set Range: 0.1~6500S

Unit: 0.1S

Factory Setting: 50.0

C033 Accel. Time 4	Unit:0.1S	Factory Setting:100.0
Set Range:0.1~6500S		

C034 Decel. Time 4	Unit:0.1S	Factory Setting:100.0
Set Range:0.1~6500S		

C035 Frequency 2	Factory Setting: 15.0
C036 Frequency 3	Factory Setting: 20.0
C037 Frequency 4	Factory Setting: 25.0
C038 Frequency 5	Factory Setting: 30.0
C039 Frequency 6	Factory Setting: 35.0
C040 Frequency 7	Factory Setting: 40.0
C041 Frequency 8	Factory Setting: 0.50

Set Range:0.0~600.0Hz Unit:0.1Hz

C042 PLC Timer 1 Set	Factory Setting: 10.0
C043 PLC Timer 2 Set	Factory Setting: 10.0
C044 PLC Timer 3 Set	Factory Setting: 0.0
C045 PLC Timer 4 Set	Factory Setting: 0.0
C046 PLC Timer 5 Set	Factory Setting: 0.0
C047 PLC Timer 6 Set	Factory Setting: 0.0
C048 PLC Timer 7 Set	Factory Setting: 0.0
C049 PLC Timer 8 Set	Factory Setting: 0.0

Set Range:0.0~6500S Unit:0.1S

The related parameters refer to the descriptions of C024, C025, C026, C027 and C028.

C050 Multi-Input FOR	Factory Setting: 02
C051 Multi-Input REV	Factory Setting: 03
C052 Multi-Input RST	Factory Setting: 10
C053 Multi-Input SPH	Factory Setting: 17
C054 Multi-Input SPM	Factory Setting: 18
C055 Multi-Input SPL	Factory Setting: 19

Set Range: 00~32	Unit: no
00: Invalid: When the terminal is set for empty, it can avoid faulse operation.	

- 01: Run: It can be combined with other terminals to combine various control methods.
- 02: Forward rotation
- 03: Reverse rotation
- 04: Stop
- 05: For/Rev switching
- 06: Jog
- 07: Jog For rotation
- 08: Jog Rev rotation
- 09: Emergency Stop: It can receive externally coming emergency stop or other fault signals. When the terminal is closed, the inverter will stop output and come to a stop at free running.
- 10: Reset: This terminal can be used to reset after the fault is removed.
- 12: Overheat of radiator or motor: This contact can be used to detect overheat of the radiator or motor to protect the motor and inverter.
- 13: Externally Controlled Timer 1 start: When the contact is closed, the timer will start and begin to count time. When the timer reaches the point the responding multi-inputs will act.
- 14: Externally Controlled Timer 2 start
- 17: High Speed: High, intermediate and low speed can compose three kinds of different operation patterns.
- 18: Intermediate Speed: In the three terminals the high-end signal has priority.
- 19: Low Speed: Low, intermediate and high speed are determined by Frequency 2, 3, 4.
- 20: Multi-speed 1
- 21: Multi-speed 2: Multi-speed 1, 2, 3 can compose 7-Steps.
- 22: Multi-speed 3
- 23: Acel/Decel Select 1: This terminal can be used to select the acel/decel time of the inverter.
- 24: Acel/Decel Select 2: 4 kinds of Acel/Decel are available for choice.
- 25: UP function: When this terminal switch acts the frequency of the inverter will increase or decrease. When the terminal switch is hold the frequency will rapidly

increment upward or decrement downward. The up or down speed is determined by the present accel/decel time. The function of power-off memory can be set through C060.

26: DOWN function

27: Counter pulse: When the terminal is set for the counter it can receive the pulse signal of $\leq 250\text{HZ}$ and count the time.

28: Counter reset: the action of this contact can clear the present counting values and restore C00 to restart counting.

29: Drawing start: When the contact is triggered the action of drawing will start.

31: Auto PLC reset suspend: This contact can be used to realize the function of suspending clear-up of Auto PLC.

A. Using the three multi-function terminals to form the connection method of three-wire system for the realization of switching FOR/REV, which is extensively applied in the case of switching For/Rev of photoelectric switches.

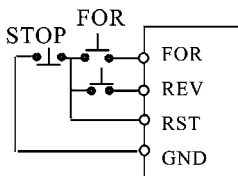

This function is only valid when C012 is set to 1.

Setting: C050=02 C051=03
C052=04 C012=1

Action Description:

When triggering FOR, the inverter will rotate forward (starting);

When triggering REV, the inverter will rotate reversely;

When pressing STOP, the inverter will stop.

B. Use RUN, DCM, F/R to combine for Starting, Stopping and For/Rev;

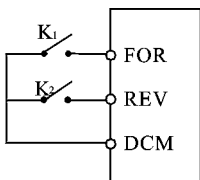

- ① Select the terminals of FOR and REV
- ② Parameter setting: C012=1 to set the external control.
C050=01 to set RUN
C051=05 to set F/R

When K2 is open it rotates forward, while K2 is closed it rotates reversely.

C. Description of Accel/Decel Time 1 and 2 Select

- (1) It is only valid when C024 is set to 0, 1, 2. Under the disturbance and internal control of multi-step it is invalid.
- (2) Any two multi-function input terminals can be combined to 4 kinds of Accel/Decel for selection.
- (3) The related multi-function input terminals are set to Accel/Decel Select 1,2. Take the terminals of SPH and SPM as example, when the terminals of SPH C053 is set to 23 and the terminals of SPM to 24, then the terminals of SPH and SPM should be Accel/Decel Time 1, 2 Select.

SPH Terminal	SPM Terminal	Result
OFF	OFF	Accel/Decel Time 1
ON	OFF	Accel/Decel Time 2
OFF	ON	Accel/Decel Time 3
ON	ON	Accel/Decel Time 4

D. Function description of High, intermediate and low terminals:

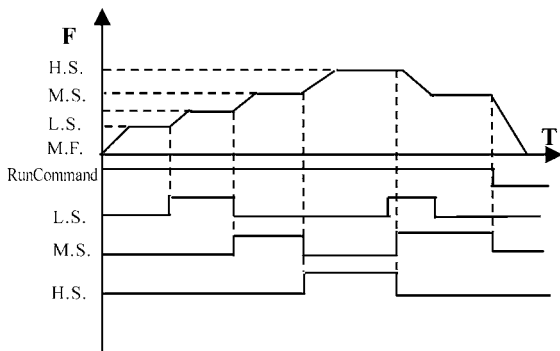

RUN	SPL Terminal	SPM Terminal	SPH Terminal	Result
ON	OFF	OFF	OFF	Main frequency and frequency run with the set value of C000.
ON	ON	OFF	OFF	Low speed and frequency run with the set value of C035.
ON	ON/OFF	ON	OFF	Intermediate speed and frequency run with the set value of C036.
ON	ON/OFF	ON/OFF	ON	High speed and frequency run with the set value of C037.

Note:

- (1) This function is only valid when C024 is set to 1, i.e. externally controlled 4-steps.
- (2) Low, intermediate and high speed frequency are determined by Frequency2,3, 4.
- (3) Accel/Decel time is determined by Accel/Decel select terminals.

(4) When all High, intermediate and low speed has signal input it will give priority in the sequence of high, intermediate and low speed.

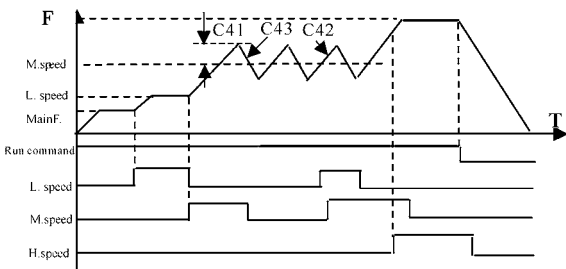

Note:

(1) When C41 is not set to 0 it has such disturbance function. Its disturbance amplitude is determined by C41.

(2) Its down time of disturbance is set by C43, while its up time is set by C42.

E. Description of UP and DOWN Function

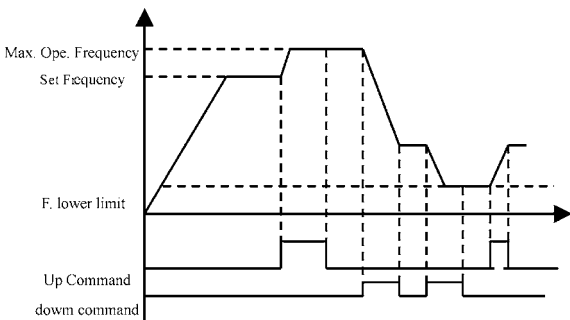

UP	DOWN	Result
ON	OFF	Frequency up
OFF	ON	Frequency down
ON	ON	No up, no down

Note:

- (1) The function of UP and DOWN is only valid when the operation of Operator is detected for the source of the running frequency, i.e. C013=0.
- (2) When UP is closed the inverter's frequency will increment.
- (3) When DOWN is closed the inverter's frequency will decrement.
- (4) When both UP and DOWN are closed at the same time the frequency will neither increase nor decrease. It is regarded as invalid.
- (5) When the frequency reaches the max. operation frequency it will not increase.
- (6) When the frequency reaches the min. frequency or its low limit, it will not decrease.
- (7) It has the function of memory, including the memory for power-off. (Setting C60=1)
- (8) When adopting the function of UP and DOWN, its up and down speed rate is determined by the present Accel/Decel Tiem.
- (9) When keeping pressing UP or DOWN, the frequency will increase or decrease rapidly.
- (10) The function of UP and DOWN is valid in operation. The frequency cannot be changed during wait. 待机

F. Description of Multi-speed 1, 2 and 3 Functions

They are only valid when C024 is set to 2. Details refer to C024.

G. Description of Counter Function

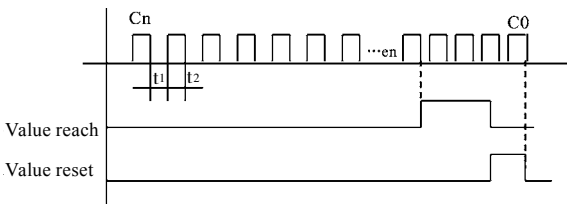

Note:

- (1) The signal width triggered should not be lower than 2msec

- (t₁、t₂≥2msec) ;
- (2)When the counting value is reached the corresponding multi-function output contact will act.
- (3) This counter is reverse counter. When the counter is reset the setting value will be displayed and then start counting.
- (4) When the counting value is reached the displayed value is 0. It will not count again and only start counting after it reset.
- (5) It has the function of memory. When C132=1, the counting result can be memorized for power-off.

C056	Multi-Output DRV	Factory Setting: 01
C057	Multi-Output FA, FB, FC	Factory Setting: 02

- 00: Invalid. When the terminal is set for no function it can prevent false action.
- 01: Run. The contact will act when the inverter is in running or receives the running command signals.
- 02: Fault indication. The contact will act when the inverter detects abnormal condition.
- 03: Zero Speed: The contact will act when the inverter output frequency is lower than its starting frequency.
- 04: DC Braking indication: The contact will act when the inverter is in DC braking condition.
- 05: Set Frequency reach: The contact will act when the output frequency reaches the set frequency.
- 06: Uniform Frequency 1 Reach: The contact will act when the output frequency reaches the designated frequency (C070).
- 07: Uniform Frequency 2 reach: The contact will act when the output frequency reaches the designated frequency (C071).
- 08: In Accel: The contact will act when the inverter is in acceleration status.
- 09: In Decel: The contact will act when the inverter is in deceleration status.
- 10: Inverter Overload alarm: The contact will act when the inverter detects overload.
- 11: Motor Overload alarm: The contact will act when the inverter detects overload of motor.
- 12: Overtorque detect: The contact will act when the inverter

- detects over torque.
- 13: Undervoltage alarm: The contact will act when the inverter detects under voltage.
 - 14: Single Step end: The contact will act and output a pulse when the inverter finishes a single step in implementation of pattern operation.
 - 15: Process end: The contact will act and output a pulse when the inverter finishes all the steps in implementation of pattern operation (i.e. after one week).
 - 16: Set Counter reach: The contact will act when the inverter implements the external counter and the counting value is equal to the set value (C064).
 - 17: Intermediate Counter reach: The contact will act when the inverter implements the external counter and the counting value is more than or equal to the set value (C065).
 - 18: Externally Controlled Timer 1 reach: The contact will act when the timer reaches the set value.
 - 19: Externally Controlled Timer 1 reach
 - 20: 4~20mA disconnected. When the AI input signal is open the contact will act.
 - 27: Drawing Reach: The contact will act when the drawing action is finished. The contact will automatically reset when the inverter stops.
 - 28: PID Lower Limit alarm: This contact will act when the PID feedback quantity is lower than the lower limit (C108).
 - 29: PID Upper Limit alarm: This contact will act when the PID feedback quantity is higher than the upper limit (C107).
 - 30: Fan run: When the inverter is working in high temperature or in running, this contact will act.
 - 31: Electromagnetic Relay act: When the contact pulls in the corresponding multi-function terminal will act.
 - 32: Braking Resistor act: When the inverter in running and the DC voltage reaches the braking voltage the contact will act.

C058 Multi Analog AM

Set Range: 0~7

Factory Setting: 0

Function: Digital frequency output terminal, In combination with C059 it can be connected to a frequency meter with the measuring range of 10V or below for external monitoring.

- 0: Analog Quantity Output: Displaying output frequency, 0~10V corresponding to 0~ Max. operation frequency.
- 1: Analog Quantity Output: Displaying output current, 0~10V corresponding to 0~2 x Rated current.
- 2: Analog Quantity Output: Displaying output DC voltage, 0~10V corresponding to 0~1000V.
- 3: Analog Quantity Output: Displaying output AC voltage, 0~10V corresponding to 0~510/255V.
- 4: Pulse Quantity Output: The corresponding relation of pulse quantity and output frequency: 1 Pulse/Hz.
- 5: Pulse Quantity Output: The corresponding relation of pulse quantity and output frequency: 2 Pulse/Hz.
- 6: Pulse Quantity Output: The corresponding relation of pulse quantity and output frequency: 3 Pulse/Hz.
- 7: Pulse Quantity Output: The corresponding relation of pulse quantity and output frequency: 6 Pulse/Hz.

C059 Analog AM Output Gain

Set Range: 0~100%

Factory Setting: 100%

This parameter can be used to adjust the output voltage value of the multi-output AM to suit frequency meter with different measuring range and also used to correct a frequency meter. For example, for an externally connected frequency meter with the measuring range of 0~5V, a multi-function terminal can be used to display its operation frequency. Then it can be corrected with this parameter, Setting C059=50 will do.

*Note: When selecting a frequency meter please select one with measuring range below 0~10V.

C060 Up-down Mode		
Set Range: 0~1	Unit: 1	Factory Setting: 0

0: Not memorized

1: Memorized

Through the setting of this parameter whether the value changed by UP-DOWN will be memorized after stopping can be selected. When C060 is set to 1, if restarting after stopping, the value at stopping will be memorized. If restarting after power off, the values at power off will not be memorized, but the value set by C000 will be memorized. When C060 is set to 0, if restarting after stopping, it will return to the value of C000, the value changed by up-down will not be memorized..

C062 Timer 1 Time		
Set Range: 0.0~10.0	Unit: 1	Factory Setting: 0
C063 Timer 2 Time		
Set Range: 0~100	Unit: 1	Factory Setting: 0

Timer 1 is a timer of 0~10.0S and Timer 2 is a timer of 0~100S. When the timer for multi-input terminal is opened or closed the timer starts to count time. When the set time is reached the corresponding multi-output contact will act. When the timer cut off open the timer for multi-output will reach to reset time. During running, if the machine stops due to fault, the timer will count time normally and not suspend; if the machine stops due to power off, the timer will reset automatically.

he counter can be regarded as the trigger by many function outside end sons, when counter value reaches establishing value C064, corresponding many function output contact movement, after putting by counter, counter put the location, count and resume, touching off the signal can be utilized and close to the switch , photoelectric switch ,etc..

C064 Counter

Set Range: 0~9999

Unit: 1

Factory Setting: 0

An external terminal of multi-function can be used as a trigger for the counter. When the counter reaches set value C064 the corresponding multi-function output contact will act. After the counter is reset and returns it will start counting again. A proximity switch or optoelectronic switch can be used for the trigger signals.

C065 Intermediate Counter

Set Range: 0~9999

Unit: 1

Factory Setting: 0

Intermediate Counting Value is one value of counting range. When the counter reachesthis value the corresponding multi-function output contact will act and output one pulse signal. It is valid when the set value of C065 is smaller than C064.

C066 Skip Frequency 1

C067 Skip Frequency 2

C068 Skip Frequency 3

Set Range: 0.00~600.00Hz Unit: 0.1Hz Factory Setting: 0.0

C069 Skip Frequency Range

Set Range: 0.1~10.00Hz Unit: 0.1Hz Factory Setting: 0.5

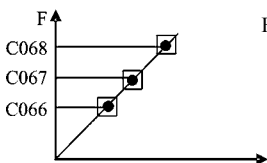

Frequency

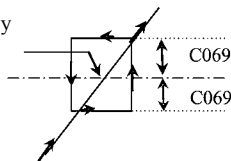

To avoid a mechanical resonance point three frequency hop points are set. In case of C069=0, all hopping frequencies are invalid. The actual hopping frequency range is two times that of C069, as shown in the above diagram.

C070 Uniform Frequency 1 Set C071 Uniform Frequency 2 Set Set Range: 0.00~600 Unit: 0.1Hz Factory Setting: 0.0
--

When the output frequency reaches the set values of C070, C071 the corresponding multi-function output contact will act.

C072 Analog Quantity Select Set Range: 0~4 Factory Setting: 0

0: 0~10V 1: 0~5V 2: 0~20mA
 3: 4~20mA 4: 0~10V and 4~20mA stacked

This parameter can be set to satisfy different analog input signals.

When C072=4, output frequency = $(U/U_{max} + I/I_{max}) * 50\text{Hz}/2$
 Among which: U: Analog Quantity Voltage Quantity; U_{max}: Maximum Analog Quantity Voltage Quantity; I: Analog Quantity Current Quantity; I_{max}: Maximum Analog Quantity Current Quantity.

For example, When +10V and 20mA are respectively entered for the analog quantity, the output frequency of the inverter is 50Hz. (In case the max. operation frequency is set to 50Hz)

C073 Analog Quantity Low End Frequency Set Range: 0.0~600.0Hz Unit: 0.1Hz Factory Setting: 0.0

074 Bias Direction of Low End Frequency Set Range: 0~1 Factory Setting: 0

0: Forward direction
 1: Reverse direction

C075 Analog Quantity High End Frequency Set Range: 0.0~600.0Hz Unit: 0.1Hz Factory Setting: 51.0

C076 Bias Direction of High End Frequency Set Range: 0~1 Factory Setting: 0

0: Forward direction
 1: Reverse direction

C077 Negative bias Reverse of Analog Quantity

Set Range: 0~1

Factory Setting: 0

0: Negative bias Rev is not allowable.

1: Negative bias Rev is allowable.

The parameter group is set for the measuring range and zero point of the external analog terminals and can be combined for any kind of curve to control the operation of the motor.

Example:

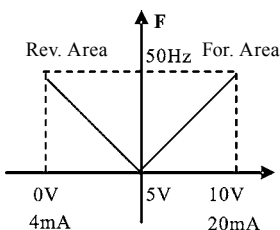

Setting: C073=50

C074=1

C075=50

C076=0

C077=1N

Note: 5~10V corresp. to
0~50Hz

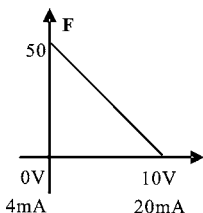

C073=50

C074=0

C075=0

C076=0

Note: 0~10V corresp. 50~0Hz

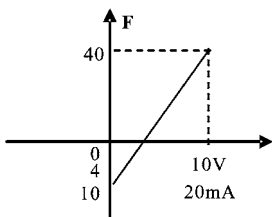

C073=10

C074=1

C075=40

C076=0

C077=1

Note: 0~10V corresp. 10~40Hz,
-10Hz means Rev 10Hz

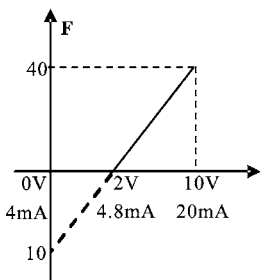

C073=10

C074=1

C073=40

C077=0

In case of C077=0, 2V-10V signal is valid; 0V-2V is invalid. Motor will not run

C078 Analog Quantity Filtering Constant

Set Range: 0~50

Unit: 1

Factory Setting: 20

The setting of this parameter is related to the responding speed of analog quantity. The higher the value of C078 is set, the slower the responding speed of analog quantity will become. Too low setting of C078 may cause the instability of frequency with fluctuation.

C079 Overvoltage Stall Prevention Select

Set Range: 0~1

Factory Setting: 1

0: Overvoltage stall prevention function is invalid.

1: Overvoltage stall prevention function is valid.

When the inverter is in decelerating, due to the effect of load inertia, the motor will produce a return energy to the inverter and cause the DC side voltage of the inverter increase. So when the function of overvoltage stall prevention is set valid and the DC voltage of the inverter becomes too high, the inverter will stop decelerating till the DC side voltage decreases to its rated value, then the inverter will go on to execute deceleration and the deceleration time will be extended automatically.

* Note: When the output voltage is higher the inverter will become abnormal or turn to protection. In such case C079 can be set to 0 (Invalid), which is easy to cause overvoltage protection.

C080 Stall Prevention Level During Acceleration

Set Range: 0~200%

Unit: 1%

Factory Setting: 150

When the inverter is in accelerating, due to over load or too short acceleration time, the output current of the inverter will go up quickly and exceed the rated standard level. When this happens, the inverter will stop accelerating until the current returns under its rated value, will the inverter go on to accelerate. When using the speed search function the value of C080 should be lowered properly. The greater the load inertia quantity is, the smaller the value of C080 should be set. Otherwise it is extremely easy to cause overcurrent protection.

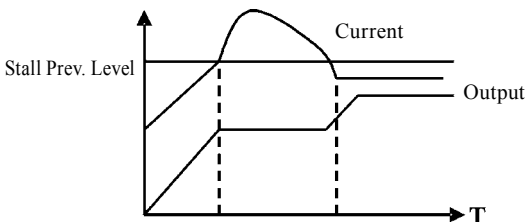

100% current is the rated current of the motor. When this parameter is set to 0, the stall prevention function is invalid.

C081 Stall Prevention Level at Constant Speed

Set Range: 0~200%

Unit: 1

Factory Setting: 0

When the inverter is in constant running, due to load fluctuation and other reasons, the current will go up. When the current exceeds its rated value, the inverter will lower the output frequency. When the output current returns to its normal range the inverter will accelerate again to its set frequency.

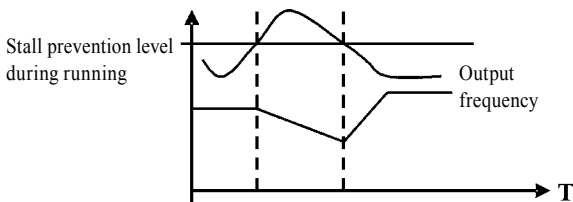

100% current is the rated current of the motor. When this parameter is set to 0, the stall prevention function is invalid.

C082 Stall Prevention Level During Deceleration

Set Range: 0~200%

Unit: 1

Factory Setting: 180

Related introduction refer to C079.

When this parameter is set to 0, the stall prevention function is invalid.

C083 OverTorque Detect Level

Set Range: 0~200%

Unit: 1%

Factory Setting: 0

When the output current exceeds the over torque detection level and also exceeds half of the set over torque detection time (factory setting: 1.0s), the over torque detection will begin to indicate, and the corresponding multi-function contact will act. When it exceeds the set time value, the inverter will turn into self-protection. But when this parameter is set to 0, the over torque detection will be invalid.

C084 OverTorque Detect Time

Set Range: 0.1~20.0S

Unit: 0.1S

Factory Setting: 1.0

When the inverter detects that the output current has exceeded the motor current set value, the inverter begins to calculate the over torque time. When the over torque time has exceeded half of the over torque detection time, the corresponding multi-function output contact will act, the over torque alarm will be produced, while the inverter will continue running. When the over torque time has exceeded the set detection time (set by

C083), the inverter will turn into self-protection, display the fault signal and stop output.

The related parameters see C083.

C085 Rated Motor Voltage

It is set according to the rated voltage value of the namplate. For 230V class inverters the default is 220, while for 400 V class inverters the default is 380V.

C086 Rated Motor Current

It is set according to the rated value of the namplate. This parameter can be used to restrict output current of the inverter to prevent overcurrent and protect the motor. If the current of the motor has exceeded this value the inverter of AC motor will turn into self-protection.

C087 Motor Poles

Set Range: 02~60

Factory Setting: 04

This parameter is set for the pole number of the motor according to the namplate of the motor.

C088 Rated Motor Revolution

Set Range: 0~9999

Factory Setting: 1440

This should be set according to the actual revolution of the motor. The displayed value is the same as this parameter. It can be used as monitoring parameter, which is convenient to the user. This parameter set value corresponds to the revolution speed at 50Hz.

C089 Motor No-load Current

Set Range: 0~100

Factory Setting: 40

The setting of Motor no-load current will affect the quantity of slip compensation. 100% current is the rated current of the motor.

C090 Slip Compensation

Set Range: 0~1.0

Factory Setting:

When the inverter drives the motor the slip will become bigger due to the increase of load. This parameter can be set for slip compensation to decrease the slip and make the running speed of the motor closer to synchronous speed of revolution.

C091 DC Braking Voltage

Set Range: 0.0~20.0%

Unit: 0.1%

Factory Setting: 2.0

This parameter is set for the DC brake voltage to of the motor at starting and stopping. It can be adjusted for different brake voltage. When adjusting the parameter it must be increased slowly from lower values to high values until the sufficient brake torque is achieved.

100% voltage is the voltage at maximum frequency.

C092 DC Braking Time at Starting

Set Range: 0.0~25.0S

Unit: 0.1S

Factory Setting: 0.0

This parameter is set for DC Brake at starting and giving the lasting time of DC Brake current of the motor at starting. If it is set to 0 it means DC brake is invalid.

DC braking before running is normally applied in the cases in which the load is movable in the “stop” state, such as windmill and other machines. Because of the load existing before the inverter drives, the motor is always in a free running state, with an uncertain running direction. So the DC braking can be executed before starting the motor to prevent the inverter from tripping.

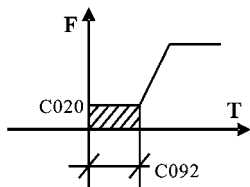

This setting is valid only when C014 is set to 0. Related introduction refer to C014.

C093 DC Braking Time at Stopping Set

Set Range: 0.0~25.0S Unit: 0.1S Factory Setting: 0.0

Note: When this parameter is set to non-zero value it starts DC brake at stopping and gives the DC brake time of the motor. DC brake at stopping is often used for a high-level stop or position control.

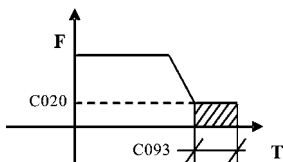

This parameter is valid when C015 is set to 0. The related parameters see C015.

C094 Speed Search Time

Set Range: 0.0~20.0S Unit: 0.1S Factory Setting: 2.0

This parameter is set as speed search time when the inverter restarts by the speed search method after the external errors or temporary power off. For the starting and stopping of some large inertia load, because of its large inertia, if restarting the machine after its complete stop, it will waste much time. But if the speed search function is started, it is not necessary to wait for the machines to come to a full stop for restart. The inverter will search the speed from high to low with the set frequency. After searching it it will continue to accelerate to reach the set frequency.

C095 Speed Search Current Level

Set Range: 0~200% Unit: 1% Factory Setting: 150

When the inverter search speed this set value should be taken as the level for output current. When the output current is higher than this level the inverter will suspend searching. When the current is restored below the current level it will then execute the speed search again.

After starting the speed search please decrease properly the speed search current level according to the actual condition

of load. Otherwise it is extremely easy to cause overcurrent protection.

C096 Restart after Instantaneous Stop

Set Range: 0~1

Factory Setting: 0

0: Invalid, i.e. the inverter will not restart after an instantaneous stop.

1: Speed search Start. Refer to C094.

C097 Allowable Power-off Time

Set Range: 0.1~5.0S

Unit: 0.1S

Factory Setting: 0.5

This parameter is set for the maximum allowable power off time. If exceeding the set time the inverter will continue to stop input after power on. To execute the restart it needs to follow the general starting procedures.

***Attention:** When using this function special attention should be paid to the safety. During the process of instantaneous power off and power on the inverter may restart. It is easy to produce danger. Be careful to use this function.

C098 Number of Abnormal Restart

Set Range: 00~10

Unit: 1

Factory Setting: 00

After the abnormal conditions (such as overcurrent, overvoltage) happen the inverter will automatically reset and restart. If the starting mode is set for general mode it will start according to the general mode. If it is set for speed search start it will start in the speed search mode. After start it will restore the set number again if there is not anything unusual happened within 60 seconds. If there is any error and it reaches the set number the inverter will not have input. It can only be started after reset. If C098 is set to 0 the inverter will not carry out the functions of automatic reset and restart.

C099 Auto Voltage Regulation

Set Range: 0~1

Factory Setting: 1

0: Invalid

1: Valid

When the input power supply is not stable and if the voltage is over high the operation of the motor with the power of exceeding the rated voltage will cause the temperature of the motor increasing, the insulation damaged and the output torque unstable. This auto voltage regulation can automatically stabilize the output voltage within the rated voltage range of the motor under the condition of unstable output power supply

When this function is set to invalid the output voltage will fluctuate.

C100 Auto Torque Compensation

Set Range: 0.1~10.0% Unit: 0.5% Factory Setting: 2.0

This parameter can be set for the auto output of extra voltage when the inverter is running for higher torque, which can compensate for the insufficient torque at lower frequency. The torque compensation should not be too big and it should be set slowly from low to high according to the actual situation.

Insufficient compensation will result in the insufficient torque of the motor at low frequency. And over compensation will lead to too bigger torque, which will produce a shock to the machine and even result in a trip of the inverter under serious situation.

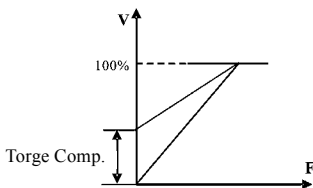

C101 Auto Energy Saving

Set Range: 0.0~20.0% Unit: 1% Factory Setting: 0

When it is set to 0 this function is invalid. When Auto energy saving function is opened the inverter will run at the full voltage during acceleration and deceleration. During the operation at constant speed the inverter can automatically calculate the optimum voltage value according to the power of load to supply

it to the load in order to meet the the goal of energy saving.
 The output voltage can be regulated automatically and it can be decreased by max. 30% of normal output voltage.

Attention: For the load of frequent change or closing to full load, this function is not applicable.

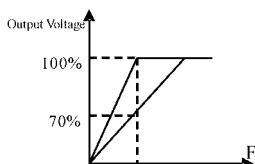

C102 PID Constant P		
Set Range: 0.0~1000%	Unit: 1	Factory Setting: 100

This proportional constant is set for the error value gain. If I=0, D=0, it is only for proportional control.

C103 PID Constant I		
Set Range: 0.1~3600	Unit: 1	Factory Setting: 5.0

The integral time (I) is set for the reaction speed for PID. The larger the I value is the slower the reaction speed is. But if the integral time value is set too small, it will cause vibration.

C104 PID Constant D		
Set Range: 0.01~10.0	Unit: 0.01	Factory Setting: 0

This didderential time (D) is set for the depression operation of PID. The larger the D value is, the more obvious the depression operation is. When D is set to 0, it means this function invalid.

C105 PID Constant Target Value		
Set Range: 0.0~100.0	Unit: 0.1	Factory Setting: 0.0

This target value can be set through external voltage signal or the digital operator. 100% target value is corresponding to the frequency quantity at +10V.

PID closed-loop control is usually used in the process control of no fast physical quantity changes, such as pressure control, temperature control, etc. The feedback signal is usually taken

from temperature, or pressure transmitter, etc. When under PID control, the feedback signal input path is the analog current signal 4-20mA.

PID Control Block Diagram:

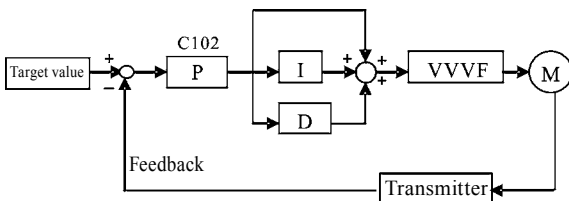

General operating methods of PID control:

- (1) Choose the correct transmitter (with the output specification of standard current signal 4-20mA)
- (2) Set the right target value.
- (3) If the output doesn't have oscillation, increase the proportional constant (P);
- (4) If the output doesn't have oscillation, decrease the integral time (Ti);
- (5) If the output doesn't have oscillation, increase the differential time (Td).

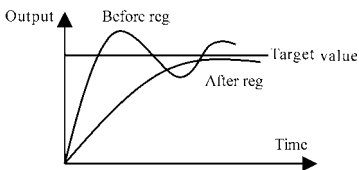

1. Decrease the Over Output
 - a: Decrease the differential time (D)
 - b: Increase the integral time (I)

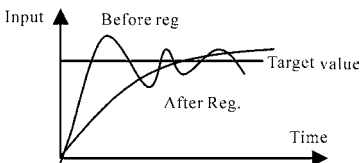

2. Decrease the oscillation
 - a: Decrease the differential time (D)
 - b: Extend the integral time (P)

PID closed-loop control is valid only when the multi-function inputs PID are open.

C106 PID Constant Target Value

Set Range: 0~1	Unit: 1	Factory Setting: 0
----------------	---------	--------------------

The selection of target value can be set through the selection of the panel or external analog quantity. The external analog quantity is 0~10V signal or control of the potentiometer.

When C106=0, the target value of PID is set by C105.

When C106=1, the target value of PID is set by external analog signal 0-10V (corresponding 0-100%), the setting of C105 is invalid.

It should be noticed that in using PID control PID is only valid when C013 is set to 0.

C107 PID Upper Limit

Set Range: 0~100%	Unit: 1	Factory Setting: 100%
-------------------	---------	-----------------------

When PID feedback value is more than the set value of C107 the corresponding multi-output terminal will act and the machine will not stop.

C108 PID Lower Limit

Set Range: 0~100%	Unit: 1	Factory Setting: 0
-------------------	---------	--------------------

When PID feedback value is less than the set value of C108 the corresponding multi-output terminal will act and the machine will not stop.

C109 Communication Addresses

Set Range: 00~250	Unit: 1	Factory Setting: 00
-------------------	---------	---------------------

When the inverter is set to have RS-485 Communication interface control, each of the inverters will be set for its individual identification number through C109.

00: No communication function

01~250: Individual identification number for the inverters

C110 Communication Baud Rate		
Set Range: 0~3	Unit: 1	Factory Setting: 1

0: 4800 b/s 1: 9600 b/s
 2: 19200 b/s 3: 34800 b/s

C111 Communication Data Method		
Set Range: 0~7	Unit: 1	Factory Setting: 1

0: 8N1 FOR ASCII 1: 8E1 FOR ASCII
 2: 8O1 FOR ASCII 3: 8N1 FOR RTU
 4: 8E1 FOR RTU 5: 8O1 FOR RTU

HLP MODBUS Communication Protocol

When using the RS485 communication interface, each of the inverters must set its own address so that the computer can use this individual address to carry out the control.

1: Communication port terminal setting



The communication protocol

has two modes: RS485Communication Port

(1) RTU mode (Remote Terminal Unit)

(2)ASCII mode (American Standand Code for imformation interchange)

Information of code.

RTU mode: Each of 8-bit data is composed of two 4-bit (hexadecimal), for example: 64H

ASCII mode: Each of 8-bit data is composed of two ASCⅡbyte, for example:

One 1-bit data 64H (hexadecimal) is composed of ASCⅡbyte “64”, included“6”(36H) and “4”(34H).

Byte	0	1	2	3	4	5	6	7
ASCII Code	30H	31H	32H	33H	34H	35H	36H	37H

Byte	8	9	A	B	C	D	E	F
ASCII Code	38H	39H	41H	42H	43H	44H	45H	46H

2: Communication Data Method

(1) 8N1 For ASCII C111=0

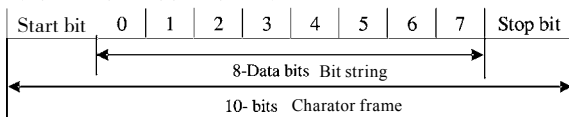

(2) 8E1 For ASCII C111=1

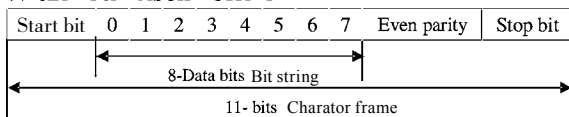

(3) 8O1 For ASCII C111=2

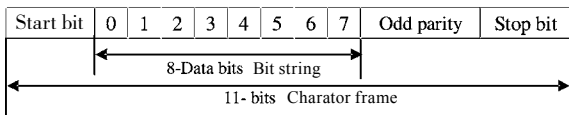

(4) 8N1 For RTU C111=3

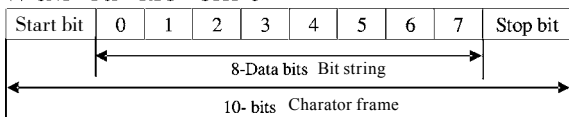

(5) 8E1 For RTU C111=4

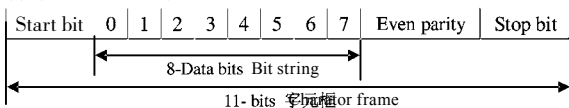

(6) 8O1 For RTU C111=5

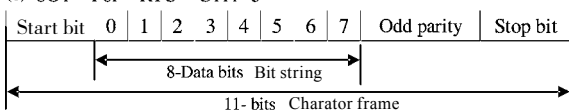

3: Communication Document Formats

3.1 ASCII Mode

Communication Document Forms

STX “:” (3AH)	ADDR	FUNC	LEN	DATA (n-1).... DATA ₀	CRC	END CR(0DH) LF(0AH)
---------------------	------	------	-----	--	-----	---------------------------

(1) STX: Starting unit“:” (3AH)

(2) ADDR communication address,8-bit data is composed of two ASCII byte.

00: Broadcast mode is MODBUS

01~250: the addresses of corresponding inverters.

(3) FUNC: Function code 8-bit data is composed of two ASCII byte.

01: FUNC READ, Read the data of function code

02: FUNC WRIT, write the data of function code

03: write control data

04: read control status data

05: write inverter frequency data

06: Reserved

07: Reserved

08: Loop test

a: Read function code data

format:

ADDR 01 LEN FUNC Data

ADDR=0 means no answer

ADDR≠0 means a reply from inverter of this address

When inverter reply normal, the format as follows:

ADDR 01 LEN FUNC Data

If DATA is one word, the LEN=3, If DATA is one byte, the LEN=2 .

When inverter has no this function code or reply no effect, the format as follows:

ADDR 81H 01 FUNC

b: Write function code data

Format:

ADDR 02 LEN FUNC Data

ADDR=0 for broadcast, it write to all inverter, but no reply.

ADDR≠0, set data and reply from inverter of this address.

When inverter has no this function code or reply of no effect, the format as follows:

ADDR 81H 01 FUNC

c: Control commands

Format:

ADDR 03 LEN CNTR

ADDR=0 for broadcast, it write to all inverter, but no reply

ADDR≠0, reply and return.

CNTR

7	6	5	4	3	2	1	0
jogr	jogf	jog	r/f	stop	rev	for	run

When the setting is correct return to present control status.

Format: ADDR 03 LEN CNST

CNST

7	6	5	4	3	2	1	0
Search start	Braking	r/f	joging	running	r/f	jog	run

When check is not correct,

ADDR 83H 01 CNST

d: Read status value

Format:

ADDR 04 01 CFG

ADDR=0, no reply

ADDR≠0, reply.

CFG=0~7, reply single data

0: Set F 1: Out F 2: Out A 3: RoTT

4: DCV 5: ACV 6: Cout 7: Tmp

For example: read set frequency

Send: 01 04 03 00 41 89

Return: 01 04 03 13 88 89 A6 2D

13 88 are data

13 is high order, 88 is low order.

(4) LEN: data length, It means the length of D(n-1)...D0, 长

Length set: when one word, LEN=3, when one byte or <1byte, LEN=2。

(5) DATA: <Data characters> data content. 2n ASCII compose n bytes, it have fifty ASCII at most.

(6) LRC: longitudinal redundancy check

ASCII mode: Get LRC methods is that add ADDR to the last data, if the result is more than 256, then the result subtract 256 until the result is less than 256 (if the result is 128H, take 28H), then 100H subtract the result get LRC.

(7) For example: write 30.00Hz to inverter of 01 (write to C000)

STX	ADDR	FUNC	LEN	DATA	LRC	END
“:”	“0”	“0”	“0”	“0” “0” “0”	“3”	“CR”
	“1”	“2”	“2”	“B” “HB” “8”	“7”	“LF”
3AH	30H	30H	30H	30H 30H 30H	33H	0DH
	31H	32H	33H	42H 42H 38H	37H	0AH

Calculate LRC: 01H+02H+03H+00H+0BH+B8H=C9H

C9H subtracted from 100H: 37H

So the sent data is following: 3AH 30H 31H 30H 32H 30H 33H 30H 30H 30H

42H 42H 38H 33H 37H 0DH 0AH

3.2 RTU Mode

Quiet	ADDR	FUNC	LEN	D _(n-1) ~D ₍₀₎	CRC	Quiet
>50ms						>50ms

(1) Quiet: the time of no data is more than 50 ms

(2) ADDR: Communication address, 8-bit data

(3) FUNC: Function code, 8-bit data, refers to 3.1-3

(4) LEN: Data length, the length of D (n-1) ~D0

(5) DATA: data content, n*8-bit

(6) LRC: Longitudinal Redundancy Check

RTU mode: get CRC (cyclical Redundancy Check).

The CRC calculation method is following:

(1) make a 16-bit register and set value 0FFFFH(call CRC register)

(2) done first byte of data Exclusive OR with low byte of 16-bit

CRC register and save the result to CRC register

(3) done 1 bit right shift with CRC register and fill zero to left bit, then check low bit of CRC register.

(4) if the low bit is zero, then do repeat step3, else CRC register do Exclusive OR with 0A001H.

(5) done repeat step 3 and 4,until CRC register done right shift 8 times,then the byte is fully done.

(6)done repeat step 2 to 5 for the next byte of data, until process completely all data. The last data of CRC register is CRC value. When send CRC value in command data, low bytes must change the sequence with high bytes, i.e. low bytes will be sent first.

(7)for example 1: Write 30.00Hz to inverter of 01

Command data

ADDR	FUNC	LEN	DATA	CRC
01H	02H	03H	00H 0BH B8H	7FH 0CH

Sent data: 01H 02H 03H 00H 0BH B8H 7FH 0CH

(8) for example 2:

The following is that get CRC value with C language. The function has two parameters:

Unsigned char data ← the point of data buffer

Unsigned char length ← number of data buffer

This function will send back the CRC value with unsigned integer format.

```

unsigned int crc_chk(unsigned char data,unsigned char
length)
{
int j;
unsigned int reg_crc=0xffff;
while (length--){
reg_crc^=*data++;
for(j=0;j<8;j++){
if(reg_crc&0x01){/*LSB(b0)=1*/
reg_crc=(reg_crc>>1)^0xa001;
}else{
reg_crc=reg_crc>>1;
}
}
}

```

```

    }
  }
}
return reg_crc;
}

```

C120 Parameter lock	Unit: 1	Factory Setting: 0
Set Range: 0~1		

0: Invalid. The parameter can be set.

1: Valid, i.e. parameter lock. Except this parameter and C000 other parameters can be changed.

This parameter can be used to prevent any wrong setting of other values by non maintenance persons.

C121 Display Contents	Factory Setting: 00
Set Range: 0~255	

DC Voltage: 1

Temperature: 2

Counter: 4

Feedback Value: 8

RPM: 16

Normally we can see directly output frequency, set frequency, output current, output voltage, but temperature, DC voltage, counter, PID feedback and revolution speed can only be monitored and displayed in sequence through switching keys after the setting of C121.

Set the corresponding code for C121. If it often displays the content of more than two items set the corresponding code for C121 again.

For example: when asking for displaying the temperature and revolution, then $C121=2+16=18$, just set C121 to 18.

C122 Inverter Model	Factory Setting: *
---------------------	--------------------

Factory Setting. It can be monitored, but not set.

C123 Rated Inverter Voltage	Factory Setting: *
-----------------------------	--------------------

Factory Setting. Depending on the model. It can be monitored, but not set.

C124 Rated Inverter Current	Factory Setting: *
-----------------------------	--------------------

Factory Setting. Depending on the model. It can't be changed. It can be monitored, but not set.

C125 Country 50/60Hz Set Range: 0~1	Factory Setting: 0
--	--------------------

0: 50Hz

1: 60Hz

Specific setting according to the grid.

C126 Inverter manufacture date	Factory Setting: ****
--------------------------------	-----------------------

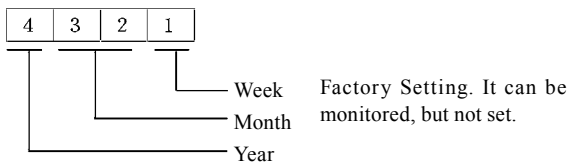

C127 Manufacture Serial No.	Factory Setting: *
-----------------------------	--------------------

Factory Setting. It can be monitored, but not set.

Through the manufacture serial number the manufavtury date, number as well as the information aobut the inverter such as the numbers of main circuit board and base plate, etc. can be checked.

C128 Parameter Reset, Fault and Clear-up	Factory Setting: 0
Set Range: 0~12	Unit: 1

0: Software Version No.

1~4: Fault record

6: Fault clear up

8: Restore factory settings

10: Input frequency at fault

11: Input current at fault

12: Bus voltage at fault

Through C128 the software version no., fault record can be checked. In case of no fault record Display 1 will appear. Enter into the parameter and set it to 0~4 so as to check fault record.

Through the setting of C128 the fault record can be cleared

up and the factory If the value has not been set properly due to some reasons or the value is abnormal it can be set to 08 to restore the factory setting and then reset again.

Items 0~4: They can be monitored, but not set.

C129 Voltage Up Time during Speed Search		
--	--	--

Set Range: 0.1~10.0S	Unit: 0.1	Unit: 0.5
----------------------	-----------	-----------

When the starting method of the inverter is set to speed search there is a process of voltage increase during the speed search. When the voltage is increase rapidly the current will be high and the searching process will be fast. When the voltage is up slowly the current will be low and the searching process will be slow. Generally the value is set less for the machine with smaller power and set more for the machine with larger power.

C130 Stall & Decel Time during Running		
--	--	--

Set Range: 0.1~25.5S	Unit: 0.1	Factory Setting: 2.5
----------------------	-----------	----------------------

Set the speed of frequency decrease for stall prevention at constant speed.

C131 Fault Reset Time		
-----------------------	--	--

Set Range: 0.2~25.0S	Unit: 0.1	Factory Setting: 1.0
----------------------	-----------	----------------------

When the inverter is set to fault restart and if the inverter has fault trip and the time exceeds the setting of C131, the inverter will restart. Pay attention to the safety when using this function.

C132 Counter Memory for Power-off		
-----------------------------------	--	--

Set Range: 0~1	Unit: 1	Factory Setting: 0
----------------	---------	--------------------

0: not memorized.

1: memorized.

*: means this setting has several choices or it should be set according to actual situation or it is factory setting.

X.Care & Maintenance, Fault Information and Troubleshooting

The inverter will keep its normal operation for long time if the maintenances and inspections can be periodically carried out for it during the use.

(1) Precautions about inspection and maintenance:

- Be sure to turn off the power supply to the inverter (R.S.T) first before the inspection and maintenance.
- After confirming the main circuit power supply has been turned off and the display has disappeared, wait until the internal indicator lamp for high voltage goes out before performing the inspection and maintenance.
- During the inspection, do not pull out or wrongly distribute the internal power supply, wires and cables. Otherwise it will cause malfunction or damage to the inverter.
- Do not leave any screw or other part inside the inverter during the installation, or it will result in the short circuit of circuit board.
- Keep the inverter clean, free from dust, oil mist and moisture after the installation.

(2) Periodical Inspection Items

- Check whether the power supply voltage conforms to the rated voltage of the inverter. (Pay special attention that whether there is any damage on the power supply wires and the motor.)
- Check whether the wiring terminals and the connectors are tight (and whether the power supply wires and terminal connection wires have any broken strand).
- Check whether there is dust, iron filings or corrosive fluid in the inverter and make periodical cleanup.
- Never measure the inverter's insulation impedance.
- Examine the output voltage, output current and output frequency of the inverter. (The difference of the measuring results should not be too big.)
- Check whether the ambient temperature of the inverter

is between -5°C and 40°C and whether the installation environment has good ventilation.

- Check whether the humidity is kept below 90%(no condensation).
- Check whether the motor makes unusual noises or abnormal vibration in running. (The inverter should not be installed in a place with high vibration.)
- Please make periodical cleaning of the ventholes.

(3) Faults Information and Troubleshooting

HLP-C⁺ series is relatively perfective with the protection functions of overload, interphase short circuit, earthing short circuit, undervoltage, overheat and overcurrent., etc. When a protection function happens with the inverter please check the reasons of fault according to the information listed in the table below. After the disposal restart the running. If the fault cannot be disposed please contact the local distributor.

Fault Display	Fault Contents & Description	Disposal methods
E.O.C.R	Overcurrent at accel	1.Check whether the motor has got short circuit or partial short circuit and whether the output wire is good. 2.Extend the acceleration time. 3.The configuration of the inveter is not reasonable and its capacity should be increased. 4.Lower the torque and increase the set value
E.O.C.n	Overcurrent at constant speed	1.Check whether the motor has got short circuit and whether the insulation of the output wires is good. 2.Check whether the motor is rotating with some external jamming force and whether there is a sudden change of mechanical load.

Fault Display	Fault Contents & Description	Disposal methods
E.O.C.n	Overcurrent at constant speed	3. Check whether the inverter's capacity is too small and increase its capacity. 4. Check whether there is a sudden change in the power grid voltage.
E.O.C.d E.O.C.S	Overcurrent at decel Overcurrent at stopping	1. Check whether the insulation of the output wires is good and whether the motor has got short circuit. 2. Extend the deceleration time. 3. Replace it with an inverter of larger capacity. 4. DC braking quantity is too high. Decrease DC braking quantity. 5. The inverter has failure. Please send it to the factory for repair.
E.O.F.S E.O.F.R E.O.F.n E.O.F.d.	Short circuit to earth	1. Check whether the connection wire of the motor has got short circuit. 2. Check whether the insulation of the output wires is good. 3. Please send it for repair.
E.O.U.S E.O.U.R E.O.U.n E.O.U.d	Overvoltage at stopping Overvoltage at accel Overvoltage at constant speed Overvoltage at decel	1. Extend the deceleration time or add a braking resistor. 2. Improve the power grid voltage and check whether there is any voltage leap happened.

Fault Display	Fault Contents & Description	Disposal
E.L.v.s E.L.v.R E.L.v.n E.L.v.d	Low voltage	1.Check whether the input voltage in normal. 2.Check whether there is sudden change in load. 3.Check whether there is any phase absent.
E.O.H.s E.O.H.R E.O.H.n E.O.H.d	Overheat of inverter	1.Check whether the fan is in stop-rotation and whether there is any foreign matter stuck in the cooling fins. 2.Check whether the ambient temperature is normal. 3.Check whether there is enough ventilation space and good air convection.
E.O.L.R E.O.L.n E.O.L.d	Inverter overload 150%1 min.	1.Check whether the capacity of the inverter is lower. Otherwise it should be increased. 2.Check whether there is any jamming in the mechanical load. 3.The setting of V/Fcurve is bad. Reset it.
E.O.F.R E.O.F.n E.O.F.d	Motor overload 150%1 min.	1.Check whether there is any sudden change in the mechanical load. 2.The equipped motor is too small. 3.The motor is hot and the insulation becomes bad. 4.Check whether the voltage has big fluctuation. 5.Check whether there is any phase absent. 6.The mechanical load is increased.

Fault Display	Fault Contents & Description	Disposal
<pre> E.o.r.A E.o.r.n E.o.r.d </pre>	Motor overtorque	1. Check whether there is any fluctuation in the mechanical load. 2. Check whether the equipped motor is smaller.
<pre> E.b.S.A E.b.S.n E.b.S.d </pre>	No feedback from auxiliary coil of the	Please contact the factory.
<pre> E.b.r.A E.b.r.n E.b.r.d </pre>	Braking transistor damage	Please send it for repair.
<pre> E.f.L.S E.f.L.n E.f.L.d </pre>	CPU fault	Please contact the factory.
<pre> E.f.P.S E.f.P.n E.f.P.d </pre>	E2Prom fault	Please contact the factory.

Er	Braking transistor	Isolate the interference source
Es	Emergency Stop	In Emergency Stop Status
20	4~20mA wire broken	Join the broken wires
Pr	Setting error	Correct the setting
DCb	DC braking	In DC braking status

Note:

(1) Fault Code Form:

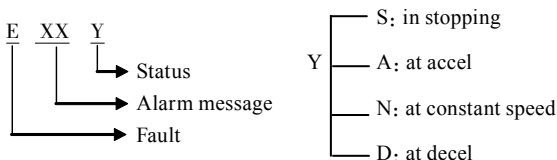

(2) Code Comparison Table:

A	B	C	D	E	F	G	H	O	S	N	L	T	P	R	U	2
A	B	C	D	E	F	G	H	O	S	N	L	T	P	R	U	2

(4) Faults and Analysis

(1) When pressing Run key the motor doesn't run.

- ① The setting of operation mode is wrong, i.e. under the operation mode of the externally controlled terminal, it is started by the operator or under the operation mode of the operator, it is started by the externally controlled terminal.
- ② The frequency command is too low or not given.
- ③ The peripheral wiring is wrong. For example, the setting of wiring of two-wire system and three-wire system and other related parameters have errors.
- ④ The setting of multi-function terminals is wrong (in the external control).
- ⑤ The inverter is in the fault protection status.
- ⑥ The motor fails.
- ⑦ The inverter fails.

(2) The parameters can be set.

- ① Password lock. Please decrypt it before setting it again.
- ② The inverter is in running.
- ③ The connection of the connecting parts is abnormal. The communication of Digital operator is abnormal. Take out the operator after poweroff and then mount it again for a trial.

(3) The motor can rotate reversely.

Reverse rotation is forbidden.

(4) The motor rotates in the opposite direction.

The output lines have been wrongly connected. Please change any three lines of U.V.W over.

(5) The deceleration of the motor is too slow.

① The setting of Decel Time is too long. Decrease Decel Time.

② Add a braking resistor.

③ Add a DC brake.

(6) Overheat of the motor

① Too big load. The actual torque has exceeded the rated torque of the motor. It is recommended to increase the capacity of motor.

② The ambient temperature is too high. In a place with higher temperature the motor will be burn out. Please decrease the temperature around the motor.

③ The phase to phase withstand voltage of the motor is insufficient.

The actions of switches of the inverter will make the winding coil of the motor produce shock wave. Normally the maximum shock voltage will reach 3 times that of input power supply of the inverter. Please select a motor with the phase to phase withstand voltage against shock higher than the maximum shock voltage.

(7) The starting of the inverter interferes other control devices

① Lower the carrier frequency and reduce the number of actions of the internal switches.

② Install a noise filter on the input side of power supply of the inverter.

③ Install a noise filter on the output side of the inverter.

④ Make correct grounding for the inverter and the motor.

⑤ Use metal tube to cover the cable to shield it.

⑥ Make separate wiring for the main circuit wires and control wires.

(8) When the fan starts an overcurrent stall is detected with the inverter.

- ① At starting the fan rotates disorderly. Please set it for DC braking at starting.
- ② DC braking at starting has been set. Please increase the DC braking value.

(9) The machine has the noise of vibration and roar

- ① The vibration frequency of mechanical system resonates with the carrier. Adjust the carrier to avoid the point of resonance.
- ② The vibration frequency of mechanical system resonates with the output frequency of the inverter.
 - a: Set skip function to avoid the point of resonance..
 - b: Put rubber vibration isolator on the base plate of motor.

XI. Selection of Peripheral Devices and Disposition

(1) Options

Description	Functions
NFB or Ground fault interrupter for wire connection	Protect the wiring of the inverter. Be sure to connect a breaker to the power supply line. Please select a ground fault circuit interrupter against high-order harmonics.
Electromagnetic contactor	In order to prevent the braking resistor from burning out, please add an electromagnetic contactor and connect a surge absorber to the coil when using it.
Surge absorber	Absorb the switching surge current from the electromagnetic contactor and control relays.
Isulating transformer	Its function of isolating the input and output of the inverter is effective to reduce the interference to other electric devices.
DC reactor	Improve the input powerfactor of the inverter.
AC reactor	Improve the input powerfactor of the inverter and prevent the shock of surge voltage.
Braking resistor, brtaking unit	Consume the regenerating energy of motor and shorten the deceleration time.

(1) Leakage switch

There is earth static capacity inside of the inverter and the motor as well as the input and output leads. Due to higher carrier frequency of the inverter the inverter has higher earth leakage current, especially for serial inverters of large capacity. When using a leakage switch it may sometimes result in the erroneous action of the protective circuit. So when using a leakage switch attention should be paid to its selection and the proper reduction of carrier frequency and shortening the leads, etc.

(2) AC reactor

An AC reactor can constrict the high-order harmonic of input

current of the inveter to improve its input power factor and prevent the shock of surge. It is recommended to use an input AC reactor under the following circumstances:

- a: Unbalancing of three-phase power supply.
- b: Any equipment with thyristors or power factor compensation unit with switching control connected to the same power supply.

(3) DC reactor

It is necessary to install a DC reactor when the capacity of power supply is more than 1000 KVA or the grid capacity is higher than the rated capacity of the inverter. An DC reactor is also needed for the case with higher demand on the improvement of power factor of power supply. This DC reactor can be used together with an AC reactor to achieve the obvious effect of decreasing high-order harmonic of input. If it is necessary to install a DC reactor please contact the local distributor.

(2) Disposition

(1) DC reactor

Model	Current	Inductance (mH)
00D423B	2.5	4.2
0D7523B	5.0	2.1
01D523B	10	1.1
0D7543B	2.5	8.4
01D543B	5.0	4.2
02D243B	7.5	3.6

(2) AC reactor

	Model	Current (A)	Inductance (mH)
220V class	00D423B	2.5	4.2
	0D7523B	5	2.1
	01D523B	10	1.1

	Model	Current (A)	Inductance (mH)
380V class	0D7543B	2.5	8.4
	01D543B	5	4.2
	02D243B	7.5	3.6

(3) Braking resistor

Inverter model	Specification		Braking torque 10%ED	Special Motor KW
	W	Q		
HLPC ⁺ 00D423B	80	200	125	0.4
HLPC ⁺ 0D7523B	100	200	125	0.75
HLPC ⁺ 01D523B	300	100	125	1.5
HLPC ⁺ 0D7543B	80	750	125	0.75
HLPC ⁺ 01D543B	300	400	125	1.5
HLPC ⁺ 02D243B	300	250	125	2.2

Note:

- ① Please select the resistor value and working frequency given by our company.
- ② If it caused any damage to the inverter and other devices due to the use of any braking resistor and braking model group not supplied by our company, we will take no responsibility.
- ③ Be sure to consider the safety of the environment and ignitability when installing a braking resistor. The distance to the inverter should be 100 mm.
- ④ If it is necessary to change the resistor value and power value, please contact the local distributor.
- ⑤ In need of a braking resistor a separate order must be placed. Please contact the local distributor for details.
- ⑥ For any machine with larger inertia the capacity of the braking resistor should be increased. Please contact the local distributor for details.

XII. Appendices

Appendix 1: Simple Application Example

1. Common application example of analog and multi-speed steps
Requirement: The frequency for the first step is given by analog quantity. Afterswitching with a switch turn to the operation of external multi-speed.

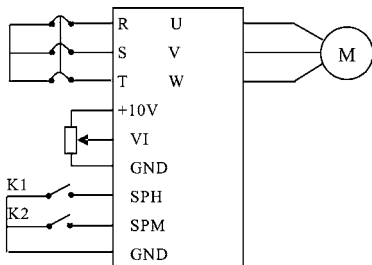

Action Description:

①

K1State	K2 State	Running Frequency
OFF	OFF	Given by the potentiometer
ON	OFF	Speed Step 2 (15Hz)
OFF	ON	Speed Step 3 (30Hz)
ON	ON	Speed Step 4 (25Hz)

②For/Rev switching can be carried out by switching of multi-function terminals or switching of For/Rev on the panel (The switching of For/Rev on the panel is adopted in this example.)

2. On common drive of multi inverters.

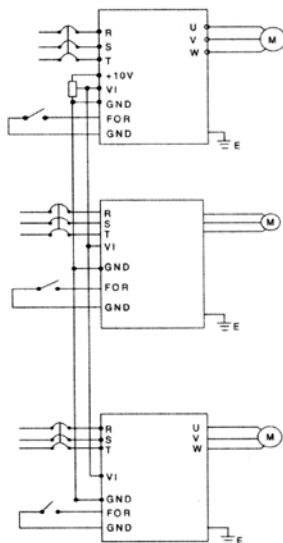

Note:

- ① The frequency of the main machine can be set by the potentiometer.
- ② The proportional relation of each inverter can be adjusted by C075.

For example, when $F_{\text{变频1}} : F_{\text{变频2}} : F_{\text{变频3}} = 1 : 2 : 3$, then the parameter of C075 can be changed to: Inverter 1: C075=50, Inverter 2: C075=100, Inverter 3: C075=150, when the analog quantity is 10V, the corresponding frequencies are respectively 50Hz, 100Hz, 150Hz with the proportional relation of 1: 2: 3.

- ③ For easy operation and adjustment a fine tuning potentiometer can be added. Please check and consult for details.

3. Parameter setting for the application of fast stopping

When using it in the application of loom demanding on fast stopping the parameter setting is recommended as follows:

- ① Decel Time is set to 0.1S.
- ② Give a certain DC braking quantity at stopping (if necessary install additional braking resistor).
- ③ Voltage stall prevention is set to invalid.
- ④ In need of positioning, 2 ~3-speed steps can be used for adjustment.

Appendix 2: External Appearance and Installation Dimensions

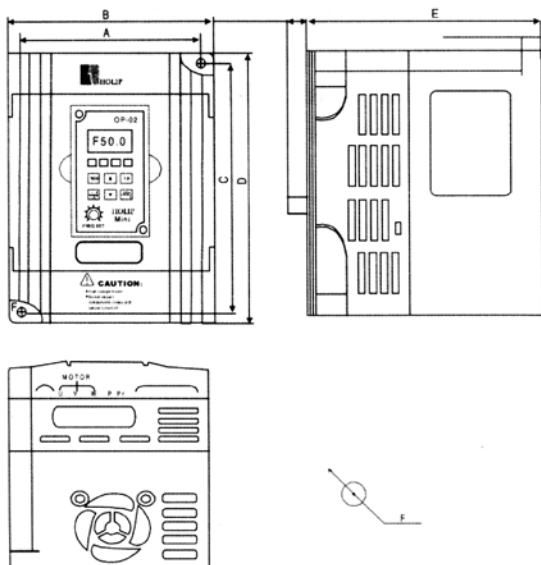

Model	A	B	C	D	E	F
HLPC ⁺ 00D423B	74	85	130	141.5	113	φ5
HLPC ⁺ 0D7523B						
HLPC ⁺ 01D523B						
HLPC ⁺ 0D7543B	89	100	140	151.0	116.5	φ5
HLPC ⁺ 01D543B						
HLPC ⁺ 02D243B						

3. Operator's External Appearance and Size (Unit: mm)

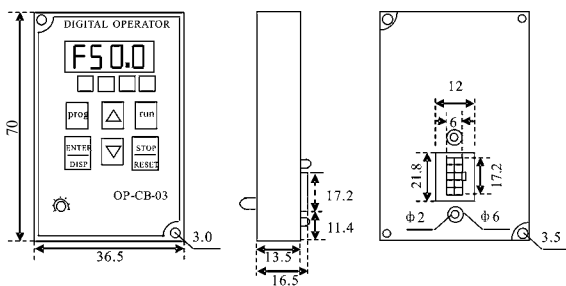

4. Explanation of Operator Model

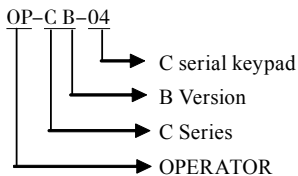

Appendix 3: User's Records and Feedback

Code	Function	Factory Setting	User's Parameter	Code	Code	Factory Setting	User's Parameter
C000	Main Frequency Set	0.0		C014	Select	0	
C001	Accel Time Set	5.0		C015	Stopping Mode Select	0	
C002	Decel Time Set	5.0		C016	Rev rotation allowable	1	
C003	V/F Curve	*		C017	STOP key select	1	
C004	Highest Voltage Set	220/380		C018	S-curve time set	0	
C005	Base Frequency Set	50/60		C019	Carrier frequency select	09	
C006	Intermediate Voltage Set	*		C020	Starting frequency set	1.5	
C007	Intermediate Frequency Set	*		C021	Stopping frequency select	1.5	
C008	Min. Voltage Set	*		C022	Jog requery select	5	
C009	Min. Frequency Set	*		C023	Jog accel/ decel select	1.0	
C010	Highest Frequency Set	50		C024	PLC operation select	0	
C011	Lower Limit Frequency Set	0		C025	Auto PLC operation select	0	
C012	Running Control	0		C026	Speed search time	0	
C013	Running Frequency Select	0		C027	PLC accel/ decel time 1	0	

Code	Function	Factory Setting	User's Parameter	Code	Code	Factory Setting	User's Parameter
C028	PLC accel/decel time 2	0		C046	PLC Timer 5 Set	0	
C029	Accel Time 2 Set	10		C047	PLC Timer 6 Set	0	
C030	Decel Time 2 Set	10		C048	PLC Timer 7 Set	0	
C031	Accel Time 3 Set	50		C049	PLC Timer 8 Set	0	
C032	Decel Time 3 Set	50		C050	Multi-input FOR	02	
C033	Accel Time 4 Set	100		C051	Multi-input REV	03	
C034	Decel Time 4 Set	100		C052	Multi-input RST	10	
C035	Frequency 2	15		C053	Multi-input SPH	17	
C036	Frequency 3	20		C054	Multi-input SPM	18	
C037	Frequency 4	25		C055	Multi-input SPL	19	
C038	Frequency 5	30		C056	Multi-input DRV	01	
C039	Frequency 6	35		C057	Multi-input FABC	02	
C040	Frequency 7	40		C058	Multi-analog AM	0	
C041	Frequency 8	0.5		C059	AM output gain of analog quantity	100	
C042	PLC Timer 1 set	10		C060	UP-DOWN mode	0	
C043	PLC timer 2 set	10		C061	UP-DOWN speed rate	0	
C044	PLC Timer 3 Set	0		C062	Timer 1 Set	0	
C045	PLC Timer 4 Set	0		C063	Timer 2 Set	0	

Code	Function	Factory Setting	User's Parameter	Code	Code	Factory Setting	User's Parameter
C064	Counter Set	0		C078	Filtering constant of analog quantity	20	
C065	Intermediate Counter Set	0		C079	Overvoltage stall select	0	
C066	Skip Frequency 1 Set	0		C080	Stall prevention level during accel.	150	
C067	Skip Frequency 2 Set	0		C081	Stall prevention level during constant speed	0	
C068	Skip Frequency 3 Set	0		C082	Stall prevention level during decel.	180	
C069	Skip Frequency Range Set	0.5		C083	Overtorque level	0	
C070	Uniform frequency 1	0		C084	Overtorque level	1.0	
C071	Uniform frequency 2	0		C085	Rated motor voltage	*	
C072	Analog input select	0		C086	Rated motor current	*	
C073	Lower Analog frequency	0.0		C087	Motor poles	04	
C074	Bias Direction at Lower Frequency	0		C088	Rated motor revolution	1440	
C075	High analog Frequency	51.0		C089	Motor no-load current	40	
C076	Bias Direction at higher Frequency	0		C090	Slip compensation set	0	
C077	Negative bias rev	0		C091	DC brake quantity set	2.0	

Code	Function	Factory Setting	User's Parameter	Code	Code	Factory Setting	User's Parameter
C092	DC brake time at starting	0		C107	PID Upper Limit	100	
C093	DC brake time at stopping	0		C108	PID Lower Limit	0	
C094	Sppeed search time	2.0		C109	Communication address	0	
C095	Speed search current level	150		C110	Communication Baud rate	1	
C096	Restart after instantaneous stop	0		C111	Communication Data Method	0	
C097	Allowable power off time	0.5		C112~119	Reserved		
C098	No. of abnormal restart	0		C120	Parameter lock	0	
C099	Auto voltage regulation	1		C121	Display content	0	
C100	Auto torque compensation	2.0		C122	Inverter model	*	
C101	Auto energy savings	0		C123	Rate inverter voltage		
C102	PID parameter P value	100		C124	Rated inverter current		
C103	PID parameter P value	5.0		C125	Inverter manufacture country		
C104	PID parameter D value	0		C126	Inverter manufacture date		
C105	PID parameter target value	*		C127	Inverter manufacture serial no.		
C106	PID parameter target value	0		C128	Fault record and clear-up, restoration of factory setting		