



HLP-A Series

Instruction





HLP-A Series

I. Introduction	1
1. Checks upon Delivery	2
2. Nameplate Description of HLP Series Inverter	3
II. Safety Precautions	4
1. Before the Power-up	4
2. During the Power-up	6
3. During the Operation	6
III. Standards and Specifications	7
1. Particular Specifications	7
2. General Specifications	9
IV. Storage and Installation	11
1. Storage	11
2. Installation Site and Environment	11
3. Installation and Direction	11
V. Wiring	13
1. Main Circuit Wiring Schematic Diagram	13
2. Description of Terminal Block	14
3. Basic Connection Diagram	16
4. Precautions on Wiring	19
VI. Instruction of the Digital Operator	23
1. Description of the Digital Operator	23
2. Description of the panel type	24
3. List of the panel used in inverter	24
4. Description of Indicator Lamp Status	24
5. Description of Operation Examples	25
VII. Commissioning	27
1. Important Checks before the Commissioning	27
2. Commissioning Methods	27
VIII. Function List	28
IX. Descriptions of Functions	35



X. Care & Maintenance, Fault Information and Troubleshooting	82
1. Precautions about Inspection and Maintenance	82
2. Periodical Inspection and Maintenance items	82
3. Fault Indication and Troubleshooting	82
4. Faults and Analysis	85
XI. Selection of Peripheral Devices and Disposition	88
1. Options	88
2. Disposition	89
XII. Appendices	93
Appendix 1: Simple Examples of Application	93
Appendix 2: Appearance and Installation Dimensions	100
Appendix 3: Appearance and Installation Dimensions	105
Appendix 4: Description of Parameter Setting for HLP-A Inverter	106
Appendix 5: User's Records and Feedback	108

I. Introduction

Thank you for purchasing and using the general-purpose inverter of HLP series of multi-functions and high performance.

Please read carefully the operation manual before putting the inverter to use so as to correctly install and operate the inverter, give full play to its functions and ensure the safety. Please keep the operation manual handy for future reference, maintenance, inspection and repair.

Due to the inverter of a kind of electrical and electronic product it must be installed, tested and adjusted with parameters by specialized engineering persons of motors.

The marks of  **Danger**  **Caution** and other symbols in the manual remind you of the safety and prevention cautions during the handling, installation, running and inspection. Please follow these instructions to make sure the safe use of the inverter. In case of any doubt please contact our local agent for consultation. Our professional persons are willing and ready to serve you.

The manual is subject to change without notice.

 **Danger** indicates wrong use may kill or injure people.

 **Caution** indicates wrong use may damage the inverter or mechanical system.

Danger

- Be sure to turn off the input power supply before wiring.
- Do not touch any internal electrical circuit or component when the charging lamp is still on after the AC power supply is disconnected, which means the inverter still has high voltage inside and it is very dangerous.
- Do not check components and signals on the circuit boards during the operation.
- Do not disassemble or modify any internal connecting cord, wiring or component of the inverter by yourself.
- Be sure to make correct ground connection of the earth terminal of the inverter.
- Never remodel it or exchange control boards and components by yourself. It may expose you to an electrical shock or explosion, etc.

 **Caution**

- Do not make any voltage-withstanding test with any component inside the inverter. These semi-conductor parts are subject to the damage of high voltage.
- Never connect the AC main circuit power supply to the output terminals U V W of the inverter.
- The main electric circuit boards of CMOS and IC of the inverter are subject to the effect and damage of static electricity. Don't touch the main circuit boards.
- Installation, testing and maintenance must be performed by qualified professional personnel.
- The inverter should be discarded as industrial waste. It is forbidden to burn it.

1. Checks upon Delivery

The inverter has been strictly and well packed before ex-work. In consideration of various factors during the transportation special attention should be paid to the following points before the assembly and installation. If there is anything abnormal please notify the dealer or the relevant people of our company.

- Check if the inverter has got any damage or deformation during the transportation and handling.
- Check if there is one piece of HLPseries inverter and one copy of the instruction manual available when unpacking it.
- Check the information on the nameplate to see if the specifications meet your order (Operating voltage and KVA value).
- Check if there is something wrong with the inner parts, wiring and circuit board.
- Check if each terminal is tightly locked and if there is any foreign article inside the inverter.
- Check if the operator buttons are all right.
- Check if the optional components you ordered are contained.
- Check if there is a certificate of qualification and a warranty card.

2. Nameplate Description of HLP Series Inverter

MODEL: HLPA07D543B
INPUT: 3PH380V50Hz
OUTPUT: 3PH380V17.5A7.5KW
Freq-Range: 0.1~400Hz
HOLIP ELECTRONICS CO., LTD.

Model: HLP A 07D5 43 B

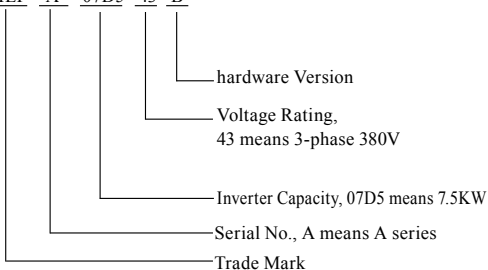

- hardware Version
- Voltage Rating,
43 means 3-phase 380V
- Inverter Capacity, 07D5 means 7.5KW
- Serial No., A means A series
- Trade Mark

II. Safety Precautions

1. Before the Power-up

Caution

- Check to be sure that the voltage of the main circuit AC power supply matches the input voltage of the inverter.
- The symbol, , represents ground terminals. Be sure to make correct ground connection of the earth terminals of the motor and the inverter for safety.
- No contactor should be installed between the power supply and the inverter to be used for starting or stopping of the inverter. Otherwise it will affect the service life of the inverter.

Danger

- R.S.T terminals are power input terminals, never mixed with U.V.W terminals. Be sure that the wiring of the main circuit is correct. Otherwise it will cause damages of the inverter when the power is applied to it.
- The terminal of  must be grounded separately and never connected to line zero. Otherwise it will easily cause the protection or errors of the inverter.

Caution

- Do not carry the front cover of the inverter directly when handling. It should be handled with the base to prevent the fall-off of the front cover and avoid the dropping of the inverter, which may possibly cause the injuries to people and the damages to the inverter.
- Mount the inverter on a metal or other noncombustible material to avoid the risk of fire.
- Install the inverter in a safe location, avoiding high temperature, direct sunlight, humid air or water.
- Keep the inverter from the reach of children or persons not concerned.
- The inverter can only be used at the places accredited by our company. Any unauthorized working environment may have the risks of fire, gas explosion, electric shock and other incidents.
- Install a heat sink or other cooling device when installing more than one inverter in the same enclosure so that the temperature inside the enclosure be kept below 40°C to avoid overheat or the risk of fire.

- Be sure to turn off the power supply before disassembling or assembling the operation keypanel and fixing the front cover to avoid bad contact causing faults or non-display of the operator.
- Do not install the inverter in a space with explosive gas to avoid the risk of explosion.
- If the inverter is used at or above 1000m above seal level, the cooling efficiency will be worse, so please run it by de-rating.
- Do not install any contactor and other components of capacitor or varistor on the output side of the inverter. Otherwise it will cause malfunctions and damages of components of the inverter.
- Do not install any switch component like air circuit breaker or contactor at the output of the inverter. If any of such components must be installed because of the requirements of process and others, it must be ensured that the inverter has no output when the switch acts. In addition, it is forbidden to install any capacitor for improvement of power factor or any varistor against thunder at the output. Otherwise it will cause malfunctions, tripping protection and damages of components of the inverter. Please remove them as shown in the below diagram.
- It will affect the service life of the inverter if a contact is connected to the front end of input of the inverter to control its starts and stops. Generally it is required to control it through FOR or REV terminals. Special attention should be paid to its use in the case of frequent starts and stops.
- Please use an independent power supply for the inverter. Do avoid using the common power supply with an electrical welder and other equipment with strong disturbance. Otherwise it will cause the protection or even damage of the inverter.

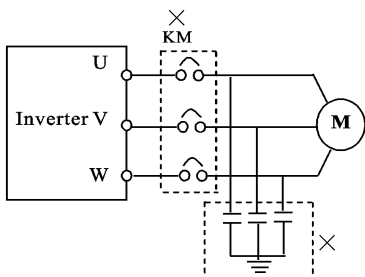

2. During the Power-up

Danger

- Do not plug the connectors of the inverter during the power up to avoid any surge into the main control board due to plugging, which might cause the damage of the inverter.
- Always have the protective cover in place before the power up to avoid electrical shock injury.

3. During the Operation

Danger

- Never connect or disconnect the motor set while the inverter is in running. Otherwise it will cause over-current trip and even burn up the main circuit of the inverter.
- Never remove the front cover of the inverter while the inverter is powered up to avoid any injury of electric shock.
- Do not come close to the machine when the fault restart function is used to avoid anything unexpected. The motor may automatically restart after its stop.
- The function of STOP Switch is only valid after setting, which is different with the use of emergent stop switch. Please pay attention to it when using it.

Caution

- Do not touch the heat sink, braking resistor, or other heat elements. These can become very hot.
- Be sure that the motor and machine is within the applicable speed ranges before starting operation because the inverter is quite easy to run from lower speed to higher speed.
- Do not check the signals on circuit boards while the inverter is running to avoid danger.
- Be careful when changing the inverter settings. The inverter has been adjusted and set before ex-work. Do not adjust it wantonly. Please make proper adjustments according to the required functions.
- Do consider the vibration, noise and the speed limit of the motor bearings and the mechanical devices when the inverter is running at or above the frequency of 50Hz.



III. Standards and Specifications

1. Particular Specifications

Type	Input Voltage	Power (KW)	Inverter Capacity (KVA)	Output Current (A)	Suitable Motor (KW)
HLPA00D423C	One & Three phase 220V 50Hz	0.4	1.0	2.5	0.4
HLPA0D7523C	One & Three phase 220V 50Hz	0.75	2.0	5.0	0.75
HLPA01D523C	One & Three phase 220V 50Hz	1.5	2.8	7.0	1.5
HLPA02D223B	One & Three phase 220V 50Hz	2.2	4.4	11	2.2
HLPA03D723B	One & Three phase 220V 50Hz	3.7	6.8	17	3.7
HLPA05D523B	One & Three phase 220V 50Hz	5.5	10	25	5.5
HLPA07D523B	One & Three phase 220V 50Hz	7.5	13.2	33	7.5
HLPA001123B	One & Three phase 220V 50Hz	11	19.6	49	11
HLPA001523B	One & Three phase 220V 50Hz	15	26	65	15
HLPA18D523B	One & Three phase 220V 50Hz	18.5	32	80	18.5
HLPA002223B	One & Three phase 220V 50Hz	22	38.4	96	22
HLPA003023B	One & Three phase 220V 50Hz	30	52	130	30
HLPA003723B	One & Three phase 220V 50Hz	37	64	160	37
HLPA004523B	One & Three phase 220V 50Hz	45	72.8	182	45
HLPA005523B	One & Three phase 220V 50Hz	55	84	210	55
HLPA007523B	One & Three phase 220V 50Hz	75	114.4	286	75

Type	Input Voltage	Power (KW)	Inverter Capacity (KVA)	Output Current (A)	Suitable Motor (KW)
HLPAA009023B	One & Three phase 220V 50Hz	90	137.2	343	90
HLPAA0D7543C	3Φ380V 50Hz	0.75	2.2	2.7	0.75
HLPAA01D543C	3Φ380V 50Hz	1.5	3.2	4.0	1.5
HLPAA02D243C	3Φ380V 50Hz	2.2	4.0	5.0	2.2
HLPAA03D743B	3Φ380V 50Hz	3.7	6.8	8.5	3.7
HLPAA05D543B	3Φ380V 50Hz	5.5	10	12.5	5.5
HLPAA07D543B	3Φ380V 50Hz	7.5	14	17.5	7.5
HLPAA001143B	3Φ380V 50Hz	11	19	24	11
HLPAA001543B	3Φ380V 50Hz	15	26	33	15
HLPAA18D543B	3Φ380V 50Hz	18.5	32	40	18.5
HLPAA002243B	3Φ380V 50Hz	22	37	47	22
HLPAA003043B	3Φ380V 50Hz	30	52	65	30
HLPAA003743B	3Φ380V 50Hz	37	64	80	37
HLPAA004543B	3Φ380V 50Hz	45	72	91	45
HLPAA005543B	3Φ380V 50Hz	55	84	110	55
HLPAA007543B	3Φ380V 50Hz	75	116	152	75
HLPAA009043B	3Φ380V 50Hz	90	134	176	90
HLPAA011043B	3Φ380V 50Hz	110	160	210	110
HLPAA013243B	3Φ380V 50Hz	132	193	253	132
HLPAA016043B	3Φ380V 50Hz	160	230	304	160
HLPAA018543B	3Φ380V 50Hz	185	260	340	185
HLPAA020043B	3Φ380V 50Hz	200	290	380	200
HLPAA022043B	3Φ380V 50Hz	220	325	426	220
HLPAA025043B	3Φ380V 50Hz	250	381	480	250
HLPAA028043B	3Φ380V 50Hz	280	427	540	280
HLPAA030043B	3Φ380V 50Hz	300	450	580	300
HLPAA031543B	3Φ380V 50Hz	315	460	605	315
HLPAA034543B	3Φ380V 50Hz	345	502	660	345
HLPAA037543B	3Φ380V 50Hz	375	544	715	375
HLPAA040043B	3Φ380V 50Hz	400	582	765	400
HLPAA041543B	3Φ380V 50Hz	415	604	795	415

2. General Specifications

Inverter Series		HLP-A
Control Mode		SPWM
Input Power		380±15% for 380V power ; 220±15% for 220V power
5-Digits Display & Status Indicator Lamp		Displaying frequency, current, revolution, voltage, counter, temperature, forward or reserve running, and fault, etc.
Communication Control		RS-485
Operation Temperature		-10~40°C
Humidity		0-95% Relative Humidity (without dew)
Vibration		Below 0.5G
Frequency Control	Range	0.10~400.00Hz
	Accuracy	Digital : 0.01% (-10~40°C) , Analog : 0.1% (25±10°C)
	Setting Resolution	Digital : 0.01Hz, Analog : 1‰ of Max. Operating Frequency
	Output Resolution	0.01Hz
	Operator Setting Method	Press directly    to set.
	Analog Setting Method	External Voltage 0-5V, 0-10V, 4-20mA, 0-20mA.
	Other Functions	Frequency lower limit, starting frequency, stopping frequency, three skip frequencies can be respectively set.
General Control	Ramp Control	Selectable 4-speed steps ramp-up and -down time (0.1-6500s).
	V/F Curve	Set V/F curve at will
	Torque Control	Torque increase is settable by max. 10.0%. The starting torque can reach 150% at 1.0Hz.
	Multi-Inputs	6 multi-function input terminals for 8-speed steps control, program operation, switching of 4-speed Ramp, UP/DOWN function, counter, external emergency stop and other functions.

	Multi-Outputs	5 multi-function output terminals for displaying of running, zero speed, counter, external abnormality, program operation and other information and warnings.
	Other Functions	AVR (auto voltage regulation), Deceleration stop or free-stop, DC brake, auto reset and restart, frequency track, PLC control, traverse function, drawing control, auto energy-savings, carrier adjustable by max. 16KHz, etc.
Protection Functions	Overload Protection	Electronic relay protection motor Drive (for constant torque 150%/1 min. for the kinds of fan 120%/1min.)
	FUSE Protection	FUSE broken, Motor stops.
	Over-voltage	DC Voltage > 400V for 220V class DC Voltage > 800V for 380V class
	Low Voltage	DC Voltage < 200V for 220V class DC Voltage < 400V for 380V class
	Instant Stop and Restart	Restarted by frequency track after instantaneous stop.
	Stall Prevention	Anti-stall during Acc/Dec run
	Output End Shorts	Electronic circuit protecting
	Other Functions	Fin over-heat protection, restriction of reverse running, direct start after power on, fault reset, parameter lock PID, one-drive-more, etc.

IV. Storage and Installation

1. Storage

The inverter must be kept in its original package box before installation. Pay attention to the followings when keeping it in storage if the inverter is not used for the time being:

- It must be stored in a dry place without rubbish or dust.
- The suitable temperature for storage is between -20°C and $+65^{\circ}\text{C}$.
- The relative humidity required is 0-95% without condensation.
- There is no corrosive gas or liquid in the storage ambience.
- It's better to lay the inverter on a rack and keep it in a proper package.
- It is better not to store the inverter for long time. Long time storage of the inverter will lead to the deterioration of electrolytic capacity. If it needs to be stored for a long time make sure to power it up one time within a year and the power-up time should be at least above five hours. When powered up the voltage must be increased slowly with a voltage regulator to the rated voltage value.

2. Installation Site and Environment

The inverter should be installed at the following location:

- Ambient temperature -5°C to 40°C with good ventilation.
- No water drop and low moisture.
- Free from direct sunshine, high temperature and heavy dust fall.
- Free from corrosive gas or liquid.
- Less dust, oil gas and metallic particles
- Free from vibration and easy for service and inspection.
- Free from the interference of electromagnetic noise.

Attention: The ambient conditions of the inverter will affect its service life.

3. Installation and Direction

- There must be enough space left around the inverter for easy maintenance and cooling. See Diagram 1.
- The inverter must be installed vertically with the smooth ventilation for effective cooling.
- If there is any instability when installing the inverter, please put a flat

board under the inverter bottom base and install it again. If the inverter is installed on a loose surface, stress may cause damage of parts in the main circuit so as to damage the inverter.

- The inverter should be installed on non-combustible materials, such as iron plate.
- If several inverters are installed, upper and lower, together in one cabinet, please add heat dissipation plates and leave enough space between the inverters. See Diagram.

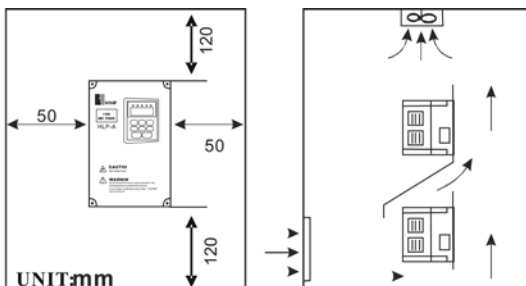

V. Wiring

1. Main Circuit Wiring Schematic Diagram

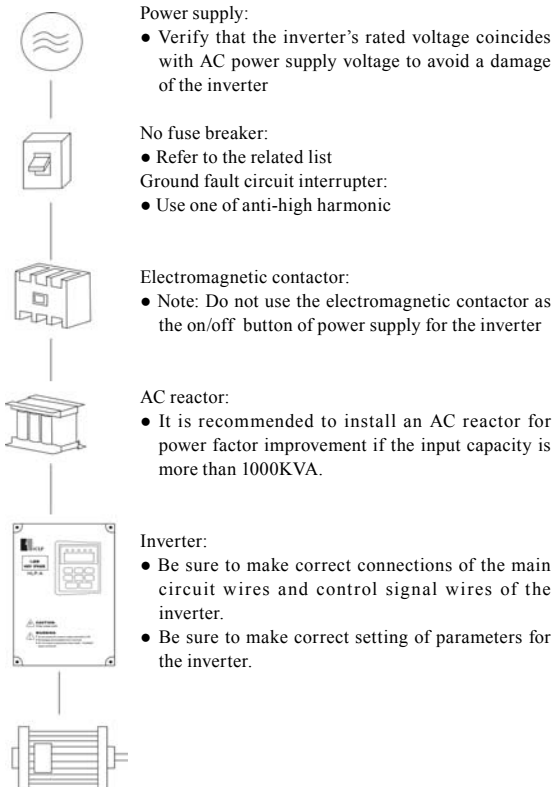

2. Description of Terminal Block

1) Arrangement of Main circuit Terminals

HLP A00D423C-HLP A01D523C

HLP A0D7543C-HLP A02D243C

E	R	S	T	U	V	W	P+	PR	
⊕	⊕	⊕	⊕	⊕	⊕	⊕	⊕	⊕	

HLP A03D743B

HLP A02D223B-HLP A03D723B

E	R	S	T	U	V	W	P	PR	
⊕	⊕	⊕	⊕	⊕	⊕	⊕	⊕	⊕	

HLP A05D543B-HLP A07D543B

E	R	S	T	U	V	W	N	P	PR
⊕	⊕	⊕	⊕	⊕	⊕	⊕	⊕	⊕	⊕

HLP A001143B-HLP A003043B

HLP A05D523B-HLP A003023B

R	S	T	E	P	N	U	V	W	
⊕	⊕	⊕	⊕	⊕	⊕	⊕	⊕	⊕	

HLP A003743B-HLP A041543B

HLP A003723B-HLP A009023B

R	S	T	E	P	PI	N	U	V	W
⊕	⊕	⊕	⊕	⊕	⊕	⊕	⊕	⊕	⊕

P _I	+	-	R	S	T	E	U	V	W
⊕	⊕	⊕	⊕	⊕	⊕	⊕	⊕	⊕	⊕

Cabinet HLP A013243BG-HLP A041543B

2) Arrangement of Control Circuit Terminals

FA	FB	FC		EV	SPL	SPM	SPH	RST	DCM	REV	FOR
KA	KB		UPF	DRV	+10	VI	AI	ACM	AM	RS-	RS+

HLPA00D423C-HLPA01D523C HLPA0D7543C-HLPA02D243C

FA	FB	FC	KA	KB	EV	UPF	DRV	DCM	SPL	SPM	⋮
----	----	----	----	----	----	-----	-----	-----	-----	-----	---

⋮	SPH	RST	REV	FOR	+10	VI	AI	ACM	AM	RS-	RS+
---	-----	-----	-----	-----	-----	----	----	-----	----	-----	-----

HLPA03D743B-HLPA041543B HLPA001123B-HLPA009023B

FA	FB	FC	KA	KB	P24	UPF	DRV	DCM	SPL	SPM	⋮
----	----	----	----	----	-----	-----	-----	-----	-----	-----	---

⋮	SPH	RST	REV	FOR	+10	VI	AI	XI	ACM	V0	A0
---	-----	-----	-----	-----	-----	----	----	----	-----	----	----

HLPA05D523B-HLPA07D523B

3) Function Description of Main circuit Terminals

Symbol	Function Description
R.S.T	Input terminal of AC line power. (220V class, for both single/three phase, single phase connected to any two phases)
U.V.W	Output terminal of the inverter
P.Pr	Connector for braking resistor.
PIP	Connector for DC reactor (When using a DC reactor the jumper shall be removed. A05D543B and A07D543B internally jumped)
P (+), N (-)	Connecting terminal of external braking bank.
E	Ground terminal: the third method of grounding for 220V and special grounding for 380 V of Electrical Engineering Regulations.

4) Function Description of Control Circuit Terminals

Symbol	Function Description	Factory setting
FOR	Multi-Input 1	Forward run
REV	Multi-Input 2	Reverse run
RST	Multi-Input 3	Reset
SPH	Multi-Input 4	High speed
SPM	Multi-Input 5	Middle Speed
SPL	Multi-Input 6	Low Speed
DCM	Common Terminal of Digital and Control Signals, +12v Power, (EV, P24) Ground	

Symbol	Function Description	Factory setting
EV	+12V Power Supply	Max. output current 200mA
P24	+12V Power Supply	Max. output current 200mA
+10	Power Supply for Speed Setting	+10V
VI	Analog Voltage Frequency Reference Input	0~+10V corresponding to the highest operating frequency
AI	Analog Current Frequency Reference Input	4~20mA corresponding to the highest operating frequency
AO	Output current	
VO	Output voltage	
ACM	Common Terminal of Analog and Control Signals	
DRV	Multi-Output 1 (Optical couple output)	DC24V/100mA
UPF	Multi-Output 2 (Optical couple output)	
FA FB FC	Multi-Output 3 (N/O or N/C)	3A/250VAC, 3A/30VDC
KA KB	Multi-Output 4 (N/O)	3A/250VAC, 3A/30VDC
AM	Output terminals of digital frequency	0~10V
RS+ RS-	RS485 Communication port	

3. Basic Connection Diagram

The wiring of the inverter is divided into two parts, main circuit terminal connections and control circuit terminal connections. The user can see the main circuit terminals, and the control circuit terminals after removing the cover of enclosure. The terminals must be connected correctly as the following wiring circuit diagrams.

The following diagram shows the factory standard connection of Model HLP-A

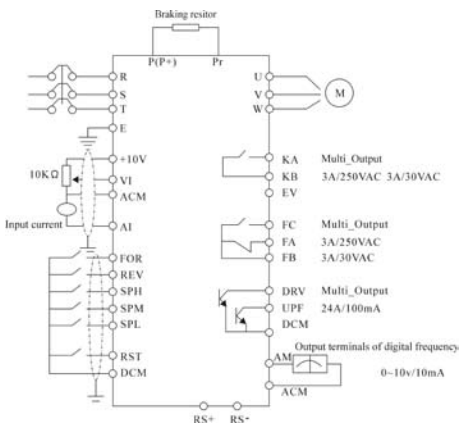

HPLA00D423C-HPLA03D723B

HPLA0D7543C-HPLA03D743B

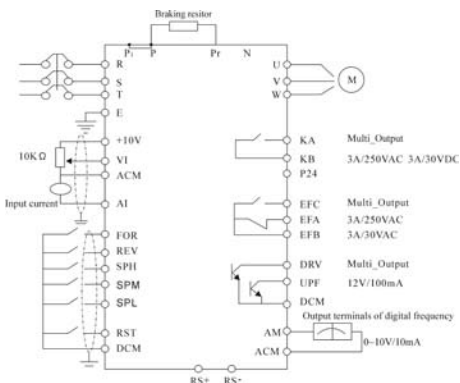

HPLA05D543B-HPLA07D543B

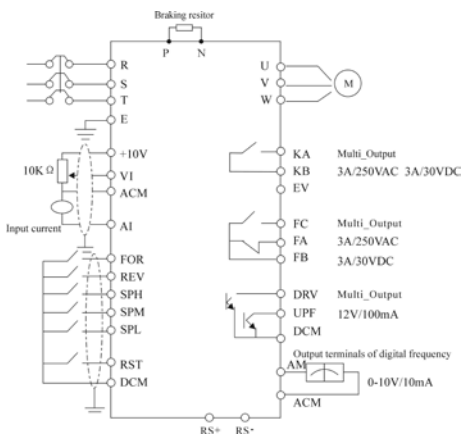

HPLA001143B~HPLA003043B

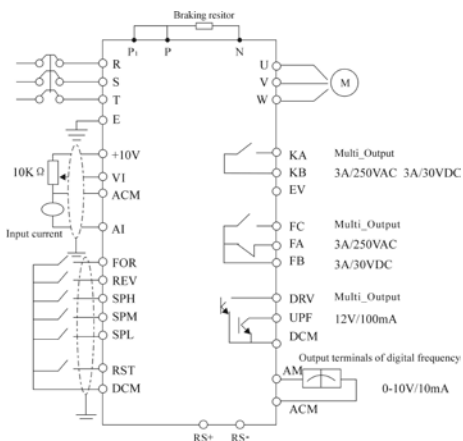

HPLA003743B~HPLA041543B

4. Precautions on Wiring

1) For the main circuit wiring:

- While wiring the sizes and specifications of wires should be selected and the wiring should be executed according to the electrical engineering regulations to ensure the safety.
- It is better to use shielded wire or wire and conduit for power cord and ground the shielded layer or two ends of wire conduit.
- Be sure to install a Non Fuse Breaker (NFB) between the power supply and the input terminals (R.S.T). (If using ground fault circuit interrupter, please choose one corresponding to high frequency)
- Never connect AC power to the output terminal (U.V.W) of the inverter.
- Output wires mustn't be in touch of the metal part of the inverter enclosure, or it will result in earth short-circuit.
- Phase-shifting capacitors, LC, RC noise filters, etc, can never be connected to the output terminals of the inverter.
- The main circuit wire must be enough far away from other control equipments.
- When the wiring between the inverter and the motor exceeds 15 meters for 220V class or 30 meters for 380V class, much higher dV/dT will be produced inside the coil of the motor, which will cause the destruction to the interlay or insulation of the motor. Please use a dedicated AC motor for the inverter or add a reactor at the inverter.
- Please lower the carrier frequency when there is a longer distance between the inverter and the motor. Because the higher the carrier frequency is the bigger the leakage current of high-order harmonics in the cables will be. The leakage current will have unfavorable effect on the inverter and other equipment.

Specifications of Non Fuse Breaker and Wire

Model	NFB(A)	Input wire mm ²	Output wire mm ²	Control wire mm ²	Screw
HLP A00D423C	16	2.5	2.5	1	M4
HLP A0D7523C	16	2.5	2.5	1	M4
HLP A01D523C	32	2.5	2.5	1	M4
HLP A02D223B	32	4	4	1	M4
HLP A03D723B	40	6	6	1	M5
HLP A05D523B	63	6	6	1	M6

Model	NFB(A)	Input wire mm ²	Output wire mm ²	Control wire mm ²	Screw
HHPA07D523B	63	6	6	1	M6
HHPA001123B	100	10	10	1	M6
HHPA001523B	160	25	25	1	M8
HHPA18D523B	160	25	25	1	M8
HHPA002223B	200	35	35	1	M10
HHPA003023B	250	70	70	1	M10
HHPA004523B	315	70	70	1	M10
HHPA005523B	400	95	95	1	M12
HHPA007523B	630	185	185	1	M12
HHPA009023B	630	240	240	1	M16
HHPA0D7543C	16	2.5	2.5	1	M4
HHPA01D543C	16	2.5	2.5	1	M4
HHPA02D243C	16	2.5	2.5	1	M4
HHPA03D743B	16	2.5	2.5	1	M4
HHPA05D543B	32	4	4	1	M5
HHPA07D543B	40	6	6	1	M5
HHPA001143B	63	6	6	1	M6
HHPA001543B	63	6	6	1	M6
HHPA18D543B	100	10	10	1	M6
HHPA002243B	100	16	16	1	M8
HHPA003043B	160	25	25	1	M8
HHPA003743B	160	25	25	1	M8
HHPA004543B	200	35	35	1	M10
HHPA005543B	200	35	35	1	M10
HHPA007543B	250	70	70	1	M10
HHPA009043B	315	70	70	1	M10
HHPA011043B	400	95	95	1	M12
HHPA013243B	400	150	150	1	M12
HHPA016043B	630	185	185	1	M12
HHPA018543B	630	240	240	1	M16
HHPA020043B	630	240	240	1	M16

Model	NFB(A)	Input wire mm ²	Output wire mm ²	Control wire mm ²	Screw
HLP A022043B	800	150×2	150×2	1	M16
HLP A025043B	800	150×2	150×2	1	M16
HLP A028043B	800	150×2	150×2	1	M16
HLP A030043B	800	150×2	150×2	1	M16
HLP A031543B	1000	185×2	150×2	1	M16
HLP A034543B	1000	185×2	150×2	1	M16
HLP A037543B	1200	240×2	185×2	1	M16
HLP A040043B	1200	240×2	185×2	1	M16
HLP A041543B	1200	240×2	185×2	1	M16

2) For control circuit wiring (signal line)

- The signal line should be separately laid in a different conduit with the main circuit wire to avoid any possible interference.
- Please use the shielded cable with the size of 0.5-2mm² for signal lines.
- Use the control terminals on the control panel correctly according to your needs.

3) Grounding

- Grounding terminal E. Be sure to make correct grounding
 220V class: The third grounding method (Grounding resistance should be 100Ω or lower.)
 380V class: The special third grounding method (Grounding resistance should be 10Ω or lower.)
- Choose grounding wires according to the basic length and size of the technical requirements of the electric equipment.
- Do avoid sharing grounding wire with other large power equipment such as electric welder, power machine, etc. The grounding wire should be kept away from the power supply wires for large power equipment.
- The grounding method for several inverters together should be done as the first and second diagrams below. Avoid the third loop.
- The grounding wire must be as shorter as possible.

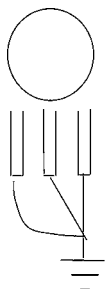

(1) Good

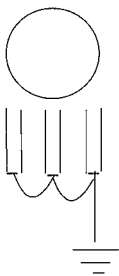

(2) Good

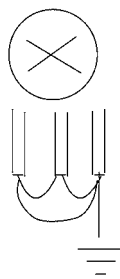

(3) Not good

VI. Instruction of the Digital Operator

1. Description of the Digital Operator

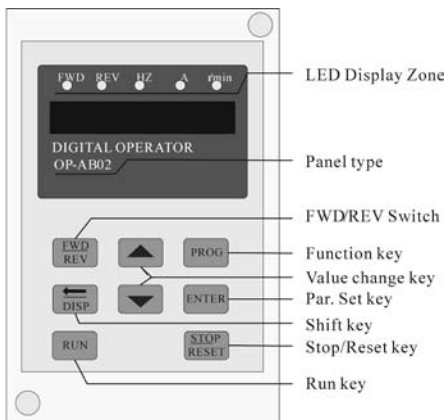
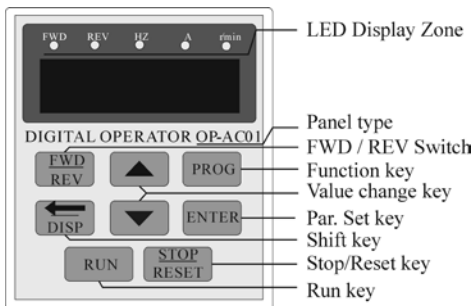

Note:

The inverter of the hardware version C can use the panel OP-AC01, the inverter of the hardware version B can use the panel OP-AB01 or OP-AB02.

The panel OP-AB01 and OP-AB02 have the same function, but different size. You can see the size in the appendix 3.

2. Description of the panel type

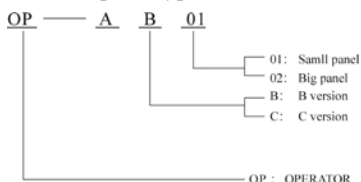

3. List of the panel used in inverter

Model	Specification	Panel type
HLP A00D423C	0.4KW/220V	OP-AC01
HLP A0D7523C	0.75KW/220V	OP-AC01
HLP A01D523C	1.5KW/220V	OP-AC01
HLP A02D223B	2.2KW/220V	OP-AB01
HLP A03D723B	3.7KW/220V	OP-AB01
HLP A05D523B	5.5KW/380V	OP-AB02
HLP A009023B	90KW/380V	
HLP A0D7543C	0.75KW/380V	OP-AC01
HLP A01D543C	1.5KW/380V	OP-AC01
HLP A02D243C	2.2KW/380V	OP-AC01
HLP A03D743B	3.7KW/380V	OP-AB01
HLP A05D543B	5.5KW/380V	OP-AB02
HLP A041543B	415KW/380V	

4. Description of Indicator Lamp Status

1) Description of Indicator Lamp Status

Indicator lamp	Status	Description
FOR	on	The motor is in forward rotation.
REV	on	The motor is in reverse rotation.
HZ	on	Displaying set frequency or output frequency.
A	on	Displaying output current.
r/min	on	Displaying rated motor revolution
A r/min	on	Displaying AC or DC voltage.
HZ r/min	on	Displaying counting value.
HZ A r/min	on	Displaying internal temperature of the inverter.

2) Description of Display Items

Display	Indic.lamp on	Meaning
750.00	HZ A R/min ☒ ○ ○	Present output frequency is 50.00HZ
F50.00	HZ A R/min ☒ ○ ○	Present set frequency is 50.00HZ
A003.0	HZ A R/min ○ ☒ ○	Present output current is 3.0A
01440	HZ A R/min ○ ○ ☒	Present output revolution is 1440r/min
510.1	HZ A R/min ○ ☒ ☒	Present DC voltage is 510.1V
380.0	HZ A R/min ○ ☒ ☒	Present AC voltage is 380.0V
35.0	HZ A R/min ☒ ☒ ☒	Present inverter's temperature is 35.0℃
00105	HZ A R/min ☒ ○ ☒	Present counter's value is 105
50.0	HZ A R/min ○ ○ ○	Present target value of PID is 50.0%
48.0	HZ A R/min ○ ○ ○	Present feedback value of PID is 48.0%
00012	HZ A R/min ☒ ☒ ○	Present time of power-on is 12 hours
00108	HZ A R/min ○ ☒ ☒	Total run time of inverter is 108 hours

5. Description of Operation Examples

Procedures	Display	Indicator Lamp	Explanation
Power up, Operation of power ↓	Dsp 2.0 flash →Vr2.00 →000.00	FOR HZ ☒ ○	Self detect when power-up, display version no. (Flahing)and finally set frequency.
PROG ↓	CD000	FOR HZ ☒ ○	Enter programming Display the function of CD000
ENYER	000.0☒	FOR HZ ☒ ○	Display the contents of CD000
▲↓← ENTER	☒0.00 END→50.00	FOR HZ ☒ ○	Change the content of CD000 Confirm changed value.
↓ PROG	CD00☒ 050.0☒	FOR HZ ☒ ○	Display END 50.00 CD001 Black from programming
↓ RUN	50.00	FOR HZ ○ ○	Display running and operating frequency
↓ ← DISP	┌50.00 └0.00→└5 0.00	FOR HZ ○ ○	Display running and opereting frequency
↓ PROG	┌005.0	FOR HZ ○ ○	Monitor screen switching, display output current

↓ ← DISP	01440	FOR A □ □	Monitor screen switching, display output current
↓ PROG	F50.00	FOR ROTT □ □	Switch back to main screen, display set frequency
↓ FWD/REV	F50.00	FOR HZ □ □	Switch of For.Rev.rotation, display the status of Rev rotation
↓ ▲	050.0	FOR HZ □ □	Switch to adjustable frequency
↓ ←▲	0.00	FOR HZ □ □	Adjust set frequency, i.e. the value of CD000
↓ ENTER	030.00	FOR HZ □ □	Adjust set frequency, i.e. the value of CD000
↓ STOP	F50.00	FOR HZ ϕ □	Stop

Note:

- ϕ means flashing. □ means bright.
- For monitoring AC, DC, T and other items they can be only switched and displayed after the parameter setting.
- When it is powered up again after a power breakdown the inverter will display the screen previous to the power breakdown after its self detection.

VII. Commissioning

1. Important Checks before the Commissioning

- If there is any wrong connected wires? Pay special attention to the terminal of U.V.W; Make sure the power supply wires are connected to R.S.T, not U.V.W.
- If there is any metal powder or wires left on the base plate of the inverter or the terminal block, which may cause short circuit.
- If screws are tightly locked and if the connecting parts are loose.
- If there is any short circuit or earth fault at outputs.

2. Commissioning Methods

The procedure of the operator is factory set up for the control mode of HLP series. The commissioning can be carried out through the digital operator. Generally, the commissioning can be conducted at 5.00 Hz.

Procedures	Display	Indicator Lamp	Explanation
Power up ↓	dsp1.1→Vr2.0 000.00	FWD Hz ● □	Self detect when power up, display version no. and finally set frequency
△	000.00	FWD Hz ● □	Switch to adjustable frequency on the panel
↓ ←△	050.00	FWD Hz ● □	Change set frequency, i.e. the value of CD000
↓ ENTER	F50.00	FWD Hz ● □	Confirm changed value
↓ RUN	F50.00	FWD Hz ● □	Run at 50Hz
↓ STOP	F50.00	FWD Hz ● □	Stop

Note: □ means indicator is on; ● means indicator lamps flash; 0 mean digits flash.

VIII. Function List

Parameter and Function List (Part 1)

Category	Code	Function	Set Range & Function Explanation	Factory Setting
Basic Parameters	CD000	Main Frequency	0.00~400.00 Hz	0.00
	CD001	Max. Voltage	0.1V—*	220/380
	CD002	Base Frequency	0.01~400.00 Hz	50.00
	CD003	Intermediate Voltage	0.1V—*	*
	CD004	Intermediate Frequency	0.01~400.00 Hz	2.50/3.00
	CD005	Min. Voltage	0.1V~*	*
	CD006	Min. Frequency	0.01~20.00 Hz	0.50
	CD007	Max Operating Frequency	10.00~400.00 Hz	50.00
	CD008	Reserved		
	CD009	Frequency Lower Limit	0.00~400.00 Hz	0.00
	CD010	Parameter Lock	0:Invalid 1:Valid	0
	CD011	Parameter Reset	00~10 08:Restore the factory setting. No other function.	00
	CD012	Accel. Time 1	0.1~6500.0S	*
	CD013	Decel. Time 1	0.1~6500.0S	*
	CD014	Accel. Time 2	0.1~6500.0S	*
	CD015	Decel. Time 2	0.1~6500.0S	*
	CD016	Accel. Time 3	0.1~6500.0S	*
	CD017	Decel. Time 3	0.1~6500.0S	*
	CD018	Accel. Time 4	0.1~6500.0S	*
	CD019	Decel. Time 4	0.1~6500.0S	*
CD020 └ CD030	Reserved			
Applicable Parameters	CD031	Starting Mode	0: Start from Starting Frequency 1: Frequency track start	0
	CD032	Stopping Mode	0: Decelerating stop 1: Coasting stop	0
	CD033	Source of Run Commands	0:Operator 1:External terminal 2:Communication port	0
	CD034	Source of Operating Frequency	0:Operator 1:External terminal 2:Communication port	0
	CD035	Carrier frequency	0~15	*
	CD036	Jogging Frequency	0.00~400.00 Hz	5.00

Parameter and Function List (Part 2)

Category	Code	Functions	Set Range & Function Explanation	Factory Setting
Applicable Parameters	CD037	Rev. Rotation Select	0: Rev Run forbidden; 1: Rev Run Enable	1
	CD038	STOP key select	0:STOP Invalid 1: STOP Valid	1
	CD039	S-Curve Time	0.0~6500.0S	0.0
	CD040	Up/down	0.01~2.50	0.01
	CD041	Starting Frequency	0.10~10.00 Hz	0.50
	CD042	Stopping Frequency	0.10~10.00 Hz	0.50
	CD043	Auto Torque Compensation	0.0-10.0%	2.0%
	CD044	Skip Frequency 1	0.00~400.00 Hz	0.00
	CD045	Skip Frequency 2	0.00~400.00 Hz	0.00
	CD046	Skip Frequency 3	0.00~400.00 Hz	0.00
	CD047	Skip Frequency Range	0.10~10.00 Hz	0.50
	CD048	Timer 1 time	0.1~10.0	0.1
	CD049	Timer 2 time	1~100	1
Input and Output Terminals	*CD050	Multi-input 1(FOR)	0: Invalid; 1:Run; 2: For rotation;3: Rev rotation; 4: Stop; 5: FOR/REV; 6: Jog; 7: Jog For rotation; 8: Jog Rev Rotation; 9: Emergent stop; 10: Reset; 11:Reserved; 12: Overheat of heat sink or motor; 17: High speed; Middle speed; 19: Low speed; 20: Multi-speed 1; 21: Multi-speed 2; 22: Multi-speed 3; 23: Ramp select 1; 24: Ramp select 2; 25: UP function; 26: DOWN function; 27: Counter; 28: Counter reset; 29: Drawing; 32: PID Start	02
	*CD051	Multi-input 2(REV)		03
	*CD052	Multi-input 3(RST)		10
	*CD053	Multi-input 4(SPH)		17
	*CD054	Multi-input 5(SPM)		18
	*CD055	Multi-input 6(SPL)		19
	*CD056	Multi-output 1(DRV)	0: Invalid; 1: Run;	01
	*CD057	Multi-output 2(UPF)	2: Fault indication; 3: Zero Speed;	05
	*CD058	Multi-output 3 (Terminals of FA,FB,FC)	4: Braking indication; 5: Set Frequency reach; 6: Arbitrary Frequency 1 reach;	02

Parameter and Function List (Part 3)

Category	Code	Functions	Set Range & Function Explanation	Factory Setting
Input and Output Terminals	*CD059	Multi-output 4 (Terminals of KA,KB)	7: Arbitrary Frequency 2 reach; 8: In Accel.; 9: In Decel.; 10: Inverter Overload alarm; 11: Motor Overload alarm; 12: Over-torque alarm; 13: Low voltage alarm; 14: Single stage end indication; 15: Process end indication; 16: Counter reach; 27: Drawing reach; 28:PID lower limit alarm; 29: PID upper limit alarm; 30: Fan act; 31: Reserved; 32: Braking resistor act	00
	CD060	Multi-output 5(AM)	Output of digital frequency signals	0
	CD061	Uniform Frequency 1	0.00~400.00 Hz	0.00
	CD062	Uniform Frequency 2	0.00~400.00 Hz	0.00
	CD063	Uniform Frequency Range	0.10~10.00 Hz	0.50
	CD064	Counting value set	0~65500	0
	CD065	Analog Input	0:0~10V 1:0~5V 2:0~20mA 3:4~20mA 4:0~10V and 4~20mA stacked	0
	CD066	Lower Analog Frequency Bias Direction at Lower Frequency	0:00~400.00 Hz 0: Positive direction 1: Negative direction	0
	CD067	Frequency		0
	CD068	Higher Analog Frequency Bias Direction at Higher Frequency	0:00~600.00 Hz 0: Positive direction 1:Negative direction	50.00
	CD069	Frequency		0
	CD070	Analog Negative Bias Reverse	0: Not allowable. 1:Allowable.	0
	CD071	AM Analog output Gain	0~100%	100
	CD072	Up/Down Function	0: Not memorized 1: Memorized	0
	CD073	Up/Down Speed	0: 0.1HZ 1: 0.01HZ	0
CD074	Analog Filtering Constant	0~50	20	
CD075	Intermediate Counter	0~65500	0	
Multi-speed and Simple PLC	CD076	PLC Operation	0: Normal run; 1: External control 4 -speed; 2:External control multi-speed; 3: Disturbance; 4: Internal control multi-speed; 5: Drawing	0

Parameter and Function List (Part 4)

Category	Code	Functions	Set Range & Function Explanation	Factory Setting
Multi-speed and Simple PLC	CD077	AutoPLC	0: Stop after running for one cycle; 1: Cycling run; 2:Auto stop after running for one cycle (STOP for intervention); 3: Auto Run and Cycling (STOP for intervention)	0
	CD078	PLC rotation Direction	0~255 (0: For 1: Rev)	0
	CD079	PLC Ramp Time	0~65535	0
	CD080	Frequency 2	0.00-400.00 Hz	15.00
	CD081	Frequency 3	0.00-400.00 Hz	20.00
	CD082	Frequency 4	0.00-400.00 Hz	25.00
	CD083	Frequency 5	0.00-400.00 Hz	30.00
	CD084	Frequency 6	0.00-400.00 Hz	35.00
	CD085	Frequency 7	0.00-400.00 Hz	40.00
	CD086	Frequency 8	0.00-400.00 Hz	0.50
	CD087	Timer 1	0.0-6500.0S	10.0
	CD088	Timer 2	0.0-6500.0S	10.0
	CD089	Timer 3	0.0-6500.0S	0.0
	CD090	Timer 4	0.0-6500.0S	0.0
	CD091	Timer 5	0.0-6500.0S	0.0
CD092	Timer 6	0.0-6500.0S	0.0	
CD093	Timer 7	0.0-6500.0S	0.0	
CD094	Timer 8	0.0-6500.0S	0.0	
CD095	AutoPLC Memory	0~1	0	
CD096 ~ CD109	Reserved			
Multi-speed and Easy PLC	CD110	Number of Auxiliary Pump	0~2	0
	CD111	Continuous Operating Time of Aux. Pumps	1~9000min	60
	CD112	Interlocking Time of Aux. Pumps	0.1~250.0s	5.0
	CD113	High Speed Running Time	1~250s	60s
	CD114	Low Speed Running Time	1~250s	60s
	CD115	Stopping Voltage Level	1~150%	95%
	CD116	Lasting Time of Stopping Voltage Level	1~250s	30s
	CD117	Wakeup Level	1~150%	80%
	CD118	Sleep Frequency	0.00~400.00	20.00
	CD119	Lasting Time of Sleep Frequency	1~250s	20s

Parameter and Function List (Part 5)

Category	Code	Functions	Set Range & Function Explanation	Factory Setting
Parameters of Protection Functions	CD120	Over-voltage Stall Prevention	0: Invalid 1: Valid	1
	CD121	Stall Prevention Level at Accel.	0~200%	150
	CD122	Stall Prevention Level at Constant Speed	0~200%	0
	CD123	Stall Prevention Level at Decel.	0~232%	0
	CD124	Over-torque Detect Mode	0~3	0
	CD125	Over-torque Detect Level	0~200%	0
	CD126	Over-torque Detect Time	0.1~20.0S	1.0
	CD127	Decel. time for stall prevention at constant speed		5.0
	CD128 CD129	Fault restart time Voltage rise time during frequency track		1.0 5
Parameters of Motor Functions	CD130 CD131 CD132 CD133	Rated Motor Voltage Rated Motor Current Motor pole number. Rated Motor Revolution	Set according to Motor nameplate Set according to Motor nameplate 02—60 00—9999	* * 04 1440
	CD134	Motor no-load current	0—100	40
	CD135	Motor slip compensation	0—1000	0
	CD136 ~ CD139	Reserved		
	CD140 CD141 CD142 CD143 CD144	DC Braking level DC Braking time at start DC Braking time at stop Frequency track time Current level for frequency track	0.0~20.0% 0.0~25.0S 0.0~25.0S 0.0~20.0S 0~200%	2.0 0.0 0.0 5.0 150

Parameter and Function List (Part 6)

Category	Code	Functions	Set Range & Function Explanation	Factory Setting
Parameters of Special Functions	CD145	Restart after instantaneous Stop	0: Invalid 1: Frequency track	0
	CD146	Allowable Power-Breakdown Time	0.1~5.0S	0.5
	CD147	Number of Abnormal Restart	0—10	00
	CD148	Restart		
	CD149	Auto Voltage Regulation Auto Energy Saving	0: Invalid 1: Valid 0.0~20.0%	1 0.0
	CD150	Proportional Constant (P)	0.0~1000.0% 0.1~*	100.0% 5.0
	CD151	Integral Time (I)	0.00~10.00S	0.00
	CD152	Differential Time (D)	0.0~100.0%	0.0
	CD153	Target value	0: set by the operator	0
	CD154	Target value select	1: set by external terminals (0-10V)	
	CD155	PID upper limit	0~100%	100%
	CD156	PID lower limit	0~100%	0%
	CD157 ~ CD159	Reserved		
Communication Functions	CD160	Communication Addresses	0-250	0
	CD161	Communication Baud Rate	0-3	1
	CD162	Communication Data Method	0-5	0
	CD163 ~ CD166	Reserved		
Monitoring Parameters	CD167	Display Items	0-31	0
	CD168	Display Items Open	0-7	0
	CD169	Voltage Rating of Inverter	Set according to the model	*
	CD170	Rated Current of Inverter	Set according to the model	*
	CD171	Software Version		*
	CD172	Fault Record 1	Note: —— means no fault record.	——
	CD173	Fault Record 2		——
	CD174	Fault Record 3		——
CD175	Fault Record 4	——		
CD176	Fault Clear	00—10 (01 for Fault Clear)	00	

Parameter and Function List (Part 7)

Category	Code	Functions	Set Range & Function Explanation	Factory Setting
Factory Setting	CD177	Inverter Model		0
	CD178	Inverter Frequency Standard	0:50Hz 1:60Hz	0
	CD179	Manufacture Date	Year: Month: Week	*
	CD180	Serial No.		*
	CD181 ~ CD250	Reserved		

IX. Descriptions of Functions

CD000	Main Frequency			**
	Set Range: 0.00-400.00 Hz	Unit: 0.01 Hz	Factory Setting: 0.00	

In the digital operator mode, the inverter will run at the set value of CD000. During running, the operating frequency can be changed by pressing ▲ or ▼. During multi-speed running, the main frequency is taken as the frequency of Speed 1.

In the external control multi-speed mode, if CD034 is set to 1, i.e. given by an external terminal, Speed 1 will be given by the analog of the external terminal. The setting of main frequency is limited by the maximum operating frequency.

The related parameters of CD034, CD076 are adjustable during operation.

CD001	Max. Voltage			
	Set Range: 0.1—*	Unit: 0.1V	Factory Setting: 220/380V	

This parameter should be set according to the rated value of the motor's nameplate. The factory setting is 380V for 380V class motor and 220V for 220V class motor. The setting range of this parameter is restricted by the voltage rating of the inverter. In case of the motor relatively far away from the inverter this set value can be increased properly.

CD002	Base Frequency			
	Set Range: 0.01—400.00 Hz	Unit: 0.01Hz	Factory Setting: 50.00	

This parameter must be set according to the rated frequency of operating voltage on the motor's nameplate. Under normal conditions do not change the set value of base frequency at will. If it is equipped with a special motor this value should be set properly according to the characteristics of the motor's parameters. Otherwise it may cause the damage to the equipment.

CD003	Intermediate voltage			
	Set Range: 0.1V—*	Unit: 0.1V	Factory Setting: *	

This parameter is set for an intermediate voltage value of arbitrary V/F curve. If it is set improperly, it will cause over-current or under-torque of the motor, or even tripping of the inverter. When the intermediate frequency is increased the voltage will increase the output torque and at the same time also the output current. When changing this parameter please pay attention to monitoring the output current to avoid the inverter's tripping due to over-current.

This set value of intermediate voltage is limited by the set value of max voltage. When the voltage is increasing to a certain value at intermediate

frequency the torque compensation will lose its function. When adjusting this parameter the output current of the inverter should be increased from low to high slowly according to the load of machines until it meets the starting requirement. Do not be quick to increase it by large amplitude. Otherwise it might cause the tripping of the inverter or the damage of the machines.

CD004 Intermediate Frequency
 Set Range: 0.01-400.00 Hz Unit: 0.01 Hz Factory Setting: 2.50/300

Note: **** means this parameter is adjustable during operation.**

This parameter is set for intermediate frequency of arbitrary V/F curve. If it is set improperly, it will cause over-current or under-torque of the motor, or even tripping of the inverter.

This set value of intermediate frequency is limited by the set value of base frequency.

Code Model	Code					Code Model	Code				
	CD003	CD005	CD012	CD013	CD035		CD003	CD005	CD012	CD013	CD035
A00D423C	15.0	7.5	5	5	9	A00I43B	19	9.5	20	20	5
A0D7523C	14.0	7	8	8	9	A00I543B	19	9.5	20	20	5
A0ID523C	14.0	7	10	10	8	A8D543B	18	9	25	25	5
A02D223B	13.0	6.5	10	10	8	A002243B	18	9	25	25	5
A03D723B	13.0	6.5	15	15	7	A003043B	17	8.5	30	30	4
A05D523B	12.0	6.0	15	15	6	A003743B	16	8	35	35	4
A07D523B	11.0	5.5	20	20	6	A004543B	16	8	40	40	4
A00I23B	10.0	5.0	25	25	5	A005543B	15	7.5	45	45	3
A00I523B	10.0	5.0	30	30	5	A007543B	15	7.5	50	50	3
A8D523B	9.0	4.5	35	35	5	A009043B	14	7	75	75	2
A00223B	9.0	4.5	50	50	4	A01I043B	14	7	100	100	2
A003023B	8.0	4.0	70	70	4	A013243B	13	6.5	150	150	2
A003723B	7.0	3.5	80	80	4	A016043B	13	6.5	150	150	2
A004523B	6.0	3.0	100	100	3	A018543B	12	6	200	200	2
A005523B	5.0	2.5	120	120	3	A020043B	12	6	200	200	2
A007523B	5.0	2.5	150	150	2	A022043B	11	5.5	250	250	2
A009023B	5.0	2.5	150	150	2	A025043B	11	5.5	250	250	2
A0D7543C	2.2	1.1	8	8	9	A028043B	11	5.5	250	250	2
A0ID543C	2.2	1.1	10	10	8	A030043B	10	5	250	250	2
A02D243C	2.1	1.05	15	15	8	A031543B	10	5	250	250	2
A03D743B	2.1	1.05	15	15	7	A034543B	10	5	250	250	2
A05D543B	2.0	1.0	15	15	6	A037543B	10	5	250	250	2
A07D543B	2.0	1.0	20	20	6	A040043B	10	5	250	250	2
						A041543B	10	5	250	250	2

- Note: ① Ramp Time 2 = Ramp Time 1 x 2
 ② Ramp Time 3 = Ramp Time 2 x 2
 ③ Ramp Time 4 = Ramp Time 3 x 2
 ④ Min.Voltage Value = Intermediate Voltage Value/2
 ⑤ The intermediate frequency is 2.5 for the system of 50Hz.
 ⑥ The intermediate frequency is 3.0 for the system of 60Hz.

CD007 Max. Operating Frequency

Set Range: 1000-400.00 Hz Unit: 0.01 Hz Factory Setting: 50.00

This parameter is set for the maximum operating frequency of the inverter.
 The following are several curves and set values often used for reference.
 Specific curves must be set according to concrete characteristics of mechanical load.

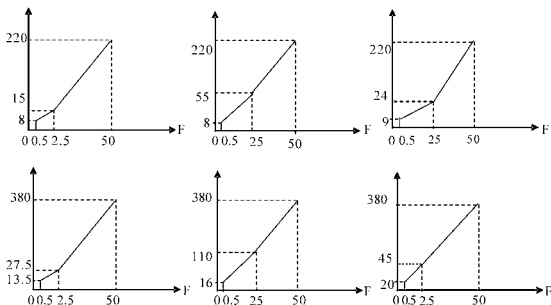

Curve of constant torque

Curve of lower torque

Curve of higher torque

CD008 Reserved
CD009 Frequency Lower Limit

**

Set Range: 0.00-400.00 Unit: 0.01 Hz Factory Setting: 0.00

This is set for preventing workers from false operation to avoid over-heat or some other mechanical faults, which might be caused due to too low operating frequency.

The setting of Frequency Lower Limit must be less than the set value of CD007.

CD010 Parameter Lock

**

Set Range: 0-1 Unit: 1 Factory Setting: 0

0: Invalid.

1: Valid, i.e. the parameters are locked. Except this parameter other parameters can not be changed.

This parameter is set to prevent non-maintenance personnel from setting other parameters by mistake. After the parameters are locked the operating frequency can be changed by pressing \triangle or ∇ .

CD011	Parameter Reset		
	Set Range: 00-10	Unit: 1	Factory Setting: 00

When the value for a parameter is set improper or is abnormal for some reasons this parameter can be set to 08 to restore it to the factory setting and then reset. After the parameters are locked (in case of CD010=1) the parameters can't be reset. They can only be reset after unlock. For related parameters refer to CD010.

CD012	Accel. Time 1		**
	Set Range: 0.1—6500.0S	Unit: 0.1S	Factory Setting: *
CD013	Decel. Time 1		**
	Set Range: 0.1—6500.0S	Unit: 0.1S	Factory Setting: *
CD014	Accel. Time 2		**
	Set Range: 0.1—6500.0S	Unit: 0.1S	Factory Setting: *
CD015	Decel. Time 2		**
	Set Range: 0.1—6500.0S	Unit: 0.1S	Factory Setting: *
CD016	Accel. Time 3		**
	Set Range: 0.1—6500.0S	Unit: 0.1S	Factory Setting: *
CD017	Decel. Time 3		**
	Set Range: 0.1—6500.0S	Unit: 0.1S	Factory Setting: *
CD018	Accel. Time 4		**
	Set Range: 0.1—6500.0S	Unit: 0.1S	Factory Setting: *
CD019	Decel. Time 4		**
	Set Range: 0.1—6500.0S	Unit: 0.1S	Factory Setting: *

Ramp-up time means the time needed for the inverter to increase the frequency from 0Hz to the maximum operating frequency (See t_1 in the diagram). Ramp-down Time means the time needed for the inverter to decrease the frequency from the maximum operating frequency to 0Hz (See t_2 in the diagram).

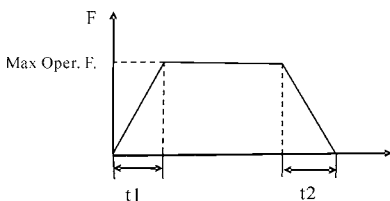

Note:

The versions previous to Vr2.0 took 50Hz as the base of ramp time.

HLP-A Series inverter have altogether 4 Ramp Times. For Ramp Time 2,3,4

the user can select the different ramp up or down time through the external terminals or switching of ramp time according to the actual needs. In the internal control multi-speed operation, different ramp time can be selected through easy PLC.

Generally the default of the inverter is Ramp Time 1, which is factory set depending on the model. Ramp Time 4 is for the jogging ramp time. For the factory setting of parameters refer to the table in CD006.

The related parameters: CD050~CD055 and CD078.

CD020~CD030	Factory Reserved
-------------	------------------

CD031	Starting Mode		
	Set Range: 0—1	Unit: 1	Factory Setting: 0

Two starting modes are available for the needs of different equipment.

0: Start from the starting frequency.

When CD141 is set to 0, i.e. DC braking is invalid at start, it starts running from the starting frequency. When CD141 is set to any non-zero value, i.e. DC braking is valid at start, it first performs a DC braking at start, and then starts from the starting frequency.

For the related parameters refer to CD040, CD140 and CD141.

1: Start by frequency track

This setting can be used for the restarting of large inertia load. When restarting, the inverter will trace the former frequency from the set frequency downward. In case of large inertia equipment, when restarting, it can implement the running command and track the former frequency right away without waiting for the complete stop of the equipment to save time.

Note: When the inverter is restarted by frequency track, it will start tracking the frequency from its set frequency downward, and search it at the highest speed. When restarting, the current becomes higher, and over-current or stall may occur. So attention must be paid to the adjustment of current level of frequency track. Generally, CD144 is adjusted around 100. The concrete value can be set according to the characteristics of mechanical load.

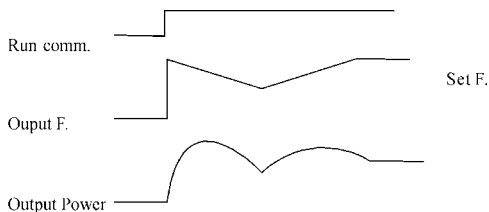

CD032 Stopping Mode	Unit: 1	Factory Setting: 0
Set Range: 0—1		

Two stopping modes are available for the needs of different equipment.

0: Decelerating Stop

When CD142 is set to 0, DC braking is invalid. When DC braking is invalid, the inverter will decelerate to the stopping frequency, and then stop outputs, and the motor will coast to stop. When CD142 is set to any non-zero value, DC braking is valid, and the inverter will first decelerate to the stopping frequency, and then stop by DC braking.

DC braking at stop is usually used for high position stop or for positioning control. It must be noticed that frequent uses of DC braking will cause over-heat of the motor.

For the related parameters refer to CD042, CD140 and CD142.

1: Coasting Stop

When the inverter receives a STOP command, it will immediately stop output and the motor will coast to stop. When the coasting stop mode is selected, DC braking is invalid.

CD033 Source of Operation Commands	Unit: 1	Factory Setting: 0
Set Range: 0—2		

0: Set by the Operator

Operation commands are given via the digital operator.

1: Set by external terminals.

Operation commands are given via external terminals, i.e. multi-input terminals

2: Set by communication ports.

Operation commands are given via communication ports.

CD034 Source of Operating Frequency	Unit: 1	Factory Setting: 0
Set Range: 0—2		

0: Set by the operator. Operating frequency is given via the digital operator.

1: Set by external terminals. Operating frequency is controlled by analog signals input via external terminals. The signal type is determined by CD065. For the related parameters refer to CD065-CD070.

2: Set by communication ports. Operating frequency is given via the serial communication.

CD034 Source of Operating Frequency	Set Range: 0—2	Unit: 1	Factory Setting: 0
-------------------------------------	----------------	---------	--------------------

- 0: Set by the operator. Operating frequency is given via the digital operator.
 1: Set by external terminals. Operating frequency is controlled by analog signals input via external terminals. The signal type is determined by CD065. For the related parameters refer to CD065-CD070.
 2: Set by communication ports. Operating frequency is given via the serial communication.

CD035 Carrier Frequency	(Note: 0—15 corresponds to 0—20K Hz)	Set Range: 0—15	Unit: 1	Factory Setting: *
-------------------------	--------------------------------------	-----------------	---------	--------------------

- 0: Set by the operator. Operating frequency is given via the digital operator.
 1: Set by external terminals. Operating frequency is controlled by analog signals input via external terminals. The signal type is determined by CD065. For the related parameters refer to CD065-CD070.
 2: Set by communication ports. Operating frequency is given via the serial communication.

Carrier Frequency	Electromagnetic Noise	Heating Capacity	Interference to the Environment
Low	High	Small	Little
↓	↓	↓	↓
High	Low	Large	Great

Set Value	0	1	2	3	4	5	6	7	8	9	10	11	12	13	14	15
Carrier Frequency KHz	0.7	1	1.5	2	3	4	5	7	8	9	10	11	13	15	17	20

As shown in the table above, the higher the carrier is, the lower the electromagnetic noise of the motor will be, but the stronger its interference to other systems will be and the greater the heating capacity of the inverter will have. Under higher ambient temperature and heavier load of the motor the carrier frequency should be decreased properly to improve the heat characteristics of the inverter.

The factory setting of carrier frequency is depending on the model. For specific data refer to the table in the description of CD006.

CD036 Jogging Frequency	Set Range: 0.00—400.00	Unit: 0.01	Factory Setting: 50	**
-------------------------	------------------------	------------	---------------------	----

The parameter set can realize the jogging function when the inverter is tested. The jogging operation can be only achieved through the external terminals, which can be set by multi-input terminals. Jogging frequency is limited by

the frequency upper/lower limits. While the jogging function is implemented, other running commands are invalid. The ramp-up time of jogging frequency is set by Ramp-up Time 4. When the jog button is released the inverter will stop output immediately. In case of jogging function please set the corresponding multi-input terminals to 07 or 08.

This function is only valid at stop. It is invalid at running. For the related parameters refer to CD050-CD055.

CD037	Rev Rotation Select		
	Set Range: 0—1	Unit: 1	Factory Setting: 1

0: Rev Rotation disable

1: Rev Rotation Enable

This function is suitable for the motor, which is not allowed to rotate reversely, to prevent workers from false operation. When the reverse rotation is disabled, the motor can only rotate forward, not reverse.

CD038	STOP key		
	Set Range: 0—1	Unit: 1	Factory Setting: 1

0: STOP invalid.

1: STOP valid.

This parameter set is only valid when CD033 is set to 1 or 2.

When the control mode is set for external terminals or communication control, STOP key on the panel can be chosen to be valid or invalid. When choosing it as valid, STOP key can stop the inverter in running. When it needs to restart, the former running signal must be released before restarting the inverter.

CD039	S-Curve Time		
	Set Range: 0.0—6500.0S	Unit: 0.1	Factory Setting: 0.0

This parameter can be set for no impact slow start or slow stop of the inverter when starting or stopping. When starting S-curve the inverter will make accelerating or decelerating curve of different speed rates according to Ramp Time.

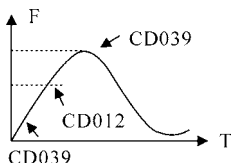

When CD039 is set as 0, S-curve is invalid, i.e. it will accelerate or decelerate in linear. Without consideration of stall the actual accel/decal time = $(CD012+CD039)/2$. The parameter is only valid when CD012 is less than CD039.

CD040 Up/down Frequency Step Length: 0.01~2.50 Factory Setting: 0.01

This parameter can be set in combination with CD073 for Up/Down of external control and the speed of increase and decrease.

the step length of Up/Down=(the set value of CD040/0.01)× UP/DOWN speed

CD041 Starting Frequency Set Range: 0.10—10.00 Hz Unit: 0.01Hz Factory Setting: 0.50

Starting frequency is the initial frequency when the inverter is started. If the starting frequency is set to 4.0Hz, the inverter will run between 4.0 Hz and the maximum operating frequency after its start at 4.0Hz . The actual maximum operating frequency is limited by the upper limit of frequency.

For the related parameters refer to CD031, CD140 and CD141.

CD042 Stopping Frequency Set Range: 0.10—10.00 Hz Unit: 0.01Hz Factory Setting: 0.50

When stopping the inverter will decrease its frequency to the stopping frequency and then stop running or start DC braking to stop.

If CD142 is set to 0, DC braking is invalid at stop and the inverter will stop running.

If CD142 is set for valid, the inverter will stop by DC braking.

For the related parameters refer to CD032, CD140 and CD142.

CD043 Auto Torque Compensation Set Range: 0.0—10.0 % Unit: 0.1% Factory Setting: 2.0%
--

This parameter can be set for the auto output of extra voltage when the inverter is running to achieve higher torque, which can compensate for the under-torque at lower frequency. The

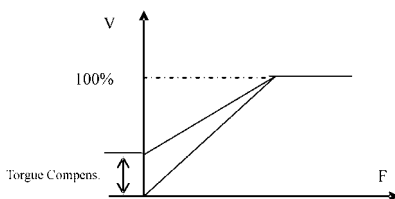

torque compensation should not be too big and it should be set slowly from low to high according to the actual situation.

Insufficient compensation will result in the under-torque of the motor at lower frequency. And over compensation will lead to too bigger torque, which will produce a shock to the machine and even result in a trip of the inverter under serious situation.

CD044	Skip Frequency 1		**
CD045	Skip Frequency 2		
CD046	Skip Frequency 3		
	Set Range: 0.00—400.00 Hz	Unit: 0.01Hz	Factory Setting: 0.00
CD047	Skip Frequency Range		**
	Set Range: 0.10—10.00 Hz	Unit: 0.01Hz	Factory Setting: 0.50

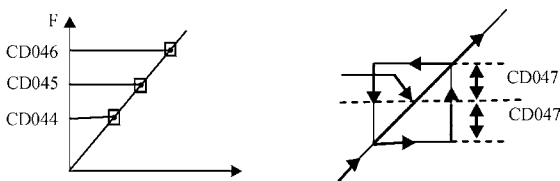

These three frequency skipping points are set for avoiding a mechanical resonance point. In case of CD047=0.1, all skip frequencies are invalid. The actual skip frequency range is two times that of CD047, as shown in the above diagram.

CD048	Timer 1 Time		
	Set Range: 0.1 ~ 10.0	Unit: 0.1	Factory Setting: 0.1
CD049	Timer 2 Time		
	Set Range: 1 ~ 100	Unit: 1	Factory Setting: 1

Timer 1 is a timer of 0.1s ~ 10.0s and Timer 2 is a timer of 1s ~ 100s. When the timer start at multi-inputs is closed (on) the timer starts to count time. When it reaches the set time the corresponding multi-output contact will act. When the timer start is opened (off) the timer time at the multi-output will be reset.

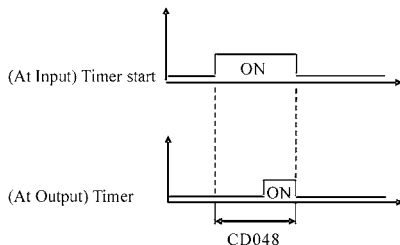

For example, set CD048=5.0s. When the external control terminal (Multi-Input) is valid the output terminal will be valid after five (5.0) seconds, the signal of which can be used to control other corresponding signals.

CD050	Multi-input 1 (FOR function)	Factory Setting: 02
CD051	Multi-input 2 (REV function)	Factory Setting: 03
CD052	Multi-input 3 (RST function)	Factory Setting: 10
CD053	Multi-input 4 (SPH function)	Factory Setting: 17
CD054	Multi-input 5 (SPM function)	Factory Setting: 18
CD055	Multi-input 6 (SPL function)	Factory Setting: 19
Set Range: 00—32 Unit: No		

- 00: Invalid. The terminal is set for empty to prevent false actions.
- 01: RUN Running. It can be combined with other terminals to compose multiple control modes.
- 02: FOR Forward Rotation
- 03: REV Reverse Rotation
- 04: STOP Stopping
- 05: FOR/REV Switching of FOR/REV rotation
- 06: JOG Jogging
- 07: Jog FOR Rotation
- 08: Jog REV Rotation
- 09: Emergent Stop: Emergent stop. It can receive external emergent stop command or other fault signals
- 10: RST Reset. This terminal can be used for reset after a fault is removed.
- 11: Reserved
- 12: Over-heat of heat sink or motor: This contact can be used to detect over-heat of the heat sink or motor to protect the motor and inverter.
- 13: External Control Timer 1 Start: When the contact is closed, the timer will start and begin to count time. When the timer reaches the set point the corresponding multi-inputs will act.
- 14: External Control Timer 2 Start
- 15~16: Reserved
- 17: High speed High, middle and low speed can compose three kinds of operation mode
- 18: Middle speed with different frequencies. In the three terminals the high-end signal has
- 19: Low speed priority. Low, Middle and High Speed are determined respectively by Frequency 2, 3, 4.
- 20: Multi-speed 1 7-speed setting can be composed through Multi-speed 1, 2, 3.
- 21: Multi-speed 2
- 22: Multi-speed 3
- 23: Ramp Time 1: This terminal can be used to select the ramp time of the inverter.
- 24: Ramp Time 2: 4 kinds of ramp time are available for choice.
- 25: UP Function When the switch of this terminal acts the frequency setting

- of the inverter will be increased or decreased by one unit. When the switch of the terminal is hold the frequency will increase or decrease rapidly to a point and then increase or decrease
- 26: Down Function at even speed. When the power is up again after the power breakdown the changed frequency will not be memorized.
- 27: Counter Pulse When this terminal is set for the counter it can receive the pulse signal of $\leq 250\text{HZ}$ and counts.
- 28: Counter Reset When this contact acts it will clear the present counting values displayed, restore C00 and restart counting.
- 29: Drawing Start When this contact is triggered the drawing action starts.
- 31: AutoPLC Reset Suspend This contact can be used to achieve the function of AutoPLC clear suspend.
- 32: PID Valid When this contact is closed, PID function starts. PID Function start is only valid during operation.

Explanation:

1. Three multi-function terminals can be used for the connection method of three-wire system for the realization of switching of FOR/REV rotation, which is extensively applied in the cases of FOR/REV switching of photoelectric switches.

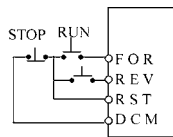

① Select FOR, REV and RST.

② Parameter setting:

CD033=1 for external control CD050=02 for FOR rotation

CD051=03 for REV Rotation CD052=04 for Stop

③ Action Description:

When triggering FOR, the inverter will rotate forward (start);

When triggering REV, the inverter will rotate reverse;

When pressing STOP, the inverter will stop.

2. RUN, DCM, F/R can be used for Start, Stop and switching of FOR/REV:

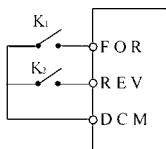

① Select FOR, REV and RST.

② Parameter setting:

CD033=1 for external control CD050=02 for FOR rotation

CD051=03 for REV Rotation CD052=04 for Stop

③ Action Description:

When triggering FOR, the inverter will rotate forward (start);

When triggering REV, the inverter will rotate reverse;

When pressing STOP, the inverter will stop.

3. Description of Ramp Time 1 and 2:

- 1) This function is only valid when CD076 is set to 0, 1 and 2. Under the disturbance and internal control multi-speed it is invalid.
- 2) Any two multi-inputs can be combined for 4 kinds of ramp time for selection.
- 3) The related multi-inputs are set for Ramp Time 1, 2. Take the terminals of SPH and SPM as example, when SPH CD053 is set to 23 and SPM CD054 is set to 24, SPH and SPM are now Ramp Time 1, 2.

SPH	SPM	Result
OFF	OFF	Ramp Time 1
ON	OFF	Ramp Time 2
OFF	ON	Ramp Time 3
ON	ON	Ramp Time 4

4. Function description of High, Middle and low speed terminals:

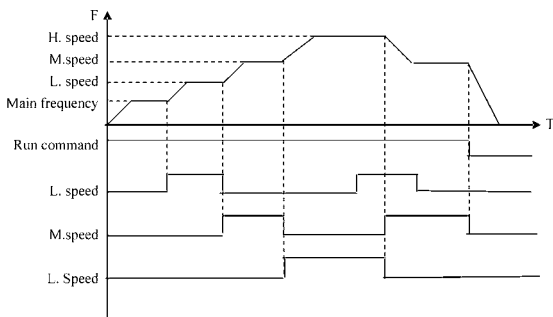

RUN	SPL	SPM	SPH	Result
ON	OFF	OFF	OFF	Main speed, the frequency runs at the set value of CD000.
ON	ON	OFF	OFF	Low speed, the frequency runs at the set value of CD080.
ON	ON/OFF	ON	OFF	Middle speed, the frequency runs at the set value of CD081.
ON	ON/OFF	ON/OFF	ON	High speed, the frequency runs at the set value of CD082.

Note:

- (1) This function is only valid when CD076 is set to 1, i.e. for 4-Speed of external control.
- (2) Low, middle and high speed frequency are determined by Frequency 2,3, 4.
- (3) Ramp time is determined by Ramp Select terminal.
- (4) When all high, middle and low speeds have signal inputs it will give priority in the sequence of high, middle and low speed.

5. Description of UP and DOWN Function:

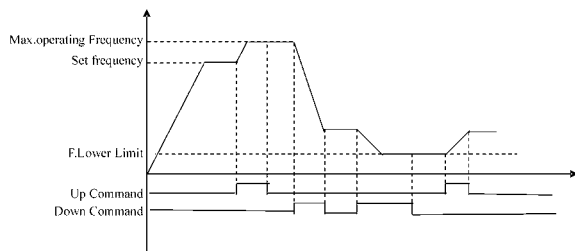

UP	DOWN	Result
ON	OFF	Frequency increase
OFF	ON	Frequency decrease
ON	ON	Not increase or decrease

Note:

- (1) The function of UP and DOWN is only valid when the operator is selected for the source of the operating frequency, i.e. CD034=0.
- (2) When the UP terminal is closed the frequency of the inverter will increase.
- (3) When the DOWN terminal is closed the frequency of the inverter will decrease.
- (4) When both UP and DOWN terminals are closed at the same time the frequency will neither increase nor decrease. It is regarded as invalid.
- (5) When the frequency reaches the max operating frequency it will stop increasing.
- (6) When the frequency reaches the min frequency or its lower limit, it will stop decreasing.
- (7) After a power breakdown the set value of CD000 will be memorized instead of the frequency.

(8) When using the function of UP and DOWN, the keys of \triangle ∇ of the panel are valid. After changing the values it needs to press SET (ENTER) key for confirmation and then the inverter can implement the action. Meanwhile the value will write to CD000, which will be memorized after a power breakdown.

(9) When keeping pressing UP or DOWN, the frequency will increase or decrease rapidly to a point and then increase or decrease at even speed.

(10) The value changed by UP or DOWN can be set through CD072 for confirmation of whether it should be memorized or not memorized. For details refer to CD072.

6. Function Description of Multi-speed 1, 2 and 3:

They are only valid when CD076 is set to 2. For details refer to CD076.

7. Function Description of Counter:

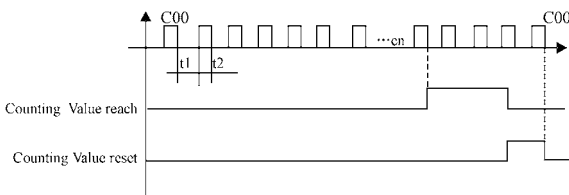

Note:

- (1) The signal width triggered should not be lower than 2 msec (t_1 , $t_2 \geq 2\text{msec}$).
- (2) When the counting value is reached the corresponding multi-output contact will act.
- (3) This counter can only count again after reset.
- (4) When reaching to 65535 the counter will not count again.

8. Description of AutoPLC Clear Suspend:

For details refer to 10. Example Application of AutoPLC Suspend in Appendix 1 and the description of related parameters in CD095.

*CD056 Multi-Output 1 (DRV function)	Factory Setting: 0F**
*CD057 Multi-Output 2 (UPF function)	Factory Setting: 05
*CD058 Multi-Output 3 (FA, FB, FC function)	Factory Setting: 02
*CD059 Multi-Output 4 (KA, KB function)	Factory Setting: 00
Set Range: 00—32 Unit: 1	

00: Invalid: The terminal is set for no function to prevent false actions.

0f: In Run: The contact will act when the inverter has output or receives the running command.

- 02: Fault Indication: The contact will act when the inverter detects abnormal conditions.
- 03: Zero Speed: The contact will act when the output frequency of the inverter is less than its starting frequency.
- 04: DC Braking indication: The contact will act when the inverter is in DC braking.
- 05: Set Frequency reach: The contact will act when the output frequency of the inverter reaches the set frequency.
- 06: Uniform Frequency 1 Reach: The contact will act when the output frequency of the inverter reaches the designated frequency (CD061).
- 07: Uniform Frequency 2 reach: The contact will act when the output frequency of the inverter reaches the designated frequency (CD062).
- 08: In Accel: The contact will act when the inverter is in ramp-up.
- 09: In Decel: The contact will act when the inverter is in ramp-down.
- 10: Inverter Over-load Alarm: The contact will act when the inverter detects over-load.
- 11: Motor Overload Alarm: The contact will act when the inverter detects over-load of the motor.
- 12: In Over-torque Detect: The contact will act when the inverter detects over-torque.
- 13: Low Voltage Alarm: The contact will act when the inverter detects low voltage.
- 14: Single Step End: The contact will act and generate one pulse when the inverter finishes a single step in implementation of program operation.
- 15: Process End: The contact will act and generate one pulse when the inverter finishes all the steps (i.e. after one cycle) in implementation of program operation.
- 16: Set Counter Reach: The contact will act when the inverter implements the external counter and the counting value is equal to the set value (CD064).
- 17: Middle Counter Reach: The contact will act when the inverter implements the external counter and the counting value is greater than or equal to the set value (CD075).
- 18: External Control Timer 1 reach: The contact will act when the timer reaches the set value.
- 19: External Control Timer 2 reach:
- 20: 4~20mA disconnected: When AI input signal is opened the contact will act.
- 25: Auxiliary Pump 1: This contact controls the starting and stopping of auxiliary pumps. For details refer to Operation of Multi-pumps.
- 26: Auxiliary Pump 2
- 27: Drawing reach: The contact will act when the drawing action is finished. The contact will automatically reset when the inverter stops.

- 28: PID Lower Limit Alarm: This contact will act when the PID feedback is smaller than the lower limit (the set value of CDI56).
- 29: PID Upper Limit Alarm: This contact will act when the PID feedback is greater than the upper limit (the set value of CDI55).
- 30: Fan act: When the temperature of the inverter is increased or it is in running, this contact will act.
- 31: Electromagnetic Relay Act: When the contact pulls in, the corresponding multi-function terminal will act.
- 32: Braking Resistor Act: When the inverter is in running and the DC voltage reaches the braking voltage the contact will act.

CD060 Multi-Output AM	**
Set Range: 0—7	Unit: 1 Factory Setting: 0

Functions: Output terminal of digital frequency, generating pulse or 0—10V analog. In combination with CD071 it can be connected with a corresponding instrument with the measuring range below 10 to be used for external monitoring.

- 0: 0~10V analog output, corresponding to output frequency. 0~10V corresponds to 0~Maximum operating frequency
- 1: 0~10V analog output, corresponding to output current. 0~10V corresponds to 0~two times of the rated current of the inverter.
- 2: Analog output, corresponding to DC bus voltage. 0~10V corresponds to 0~1000V.
- 3: Analog output, corresponding to AC output voltage. 0~10V corresponds to 0~510V/255V.
(Note: The machine type of three phase, 380V corresponds to 510V and the machine type of single phase, 220V corresponds to 255V)
- 4: Pulse Output, corresponding to operating frequency: 1 Pulse/Hz, (50% of capacity ratio)
- 5: Pulse Output, corresponding to operating frequency: 2 Pulse /Hz, (50% of capacity ratio)
- 6: Pulse Output, corresponding to operating frequency: 3 Pulse /Hz, (50% of capacity ratio)
- 7: Pulse Output, corresponding to operating frequency: 6 Pulse /Hz, (50% of capacity ratio)

CD061	Uniform Frequency 1		**
CD062	Uniform Frequency 2		
	Set Range: 0.00—400.00 Hz	Unit: 0.01 Hz	Factory Setting: 0.00
CD063	Uniform Frequency Range		**
	Set Range: 0.10—10.00 Hz	Unit: 0.01 Hz	Factory Setting: 0.50

When the output frequency is more than the uniform frequency the corresponding multi-outputs will act. The uniform frequency range acts as a hysteresis loop.

When the inverter is in the operation of multi-pumps, CD061 (Uniform Frequency 1) is used as high speed frequency and CD062 is set as low speed operating frequency. The definitions of the corresponding multi-function contacts are changed.

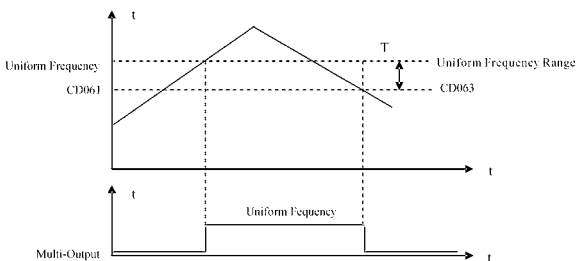

When output F is higher than uniform F, the corresp. multioutputs act. The uniform F range is used as hysteresis LOOP.

CD064	Counting Value		**
	Set Range: 0—65500	Unit: 1	Factory Setting: 0

An external terminal of multi-function can be used as a trigger for the counter. When the counter reaches the set value of CD064 the corresponding multi-output contact will act. After the counter is cleared and reset it will start counting again. A proximity switch or optoelectronic switch can be used for the triggering signals.

CD065	Analog Input		
	Set Range: 0—7	Unit: 1	Factory Setting: 0

0: 0~10V 1: 0~5V 2: 0~20mA
 3: 4~20mA 4: 0~10V and 4~20mA stacked 5-7: Invalid

This parameter can be set for different analog input signals.

When CD065=4, the output frequency = $1/2 (U/U_{max} + I/I_{max}) \times 50\text{Hz}$

Among which: U: Analog Voltage; U_{max} : Maximum Analog Voltage;
I: Analog Current; I_{max} : Maximum Analog Current.

For example, When +10V and 20mA are respectively entered for the analog input, the output frequency of the inverter is 50Hz.

CD066	Lower Analog Frequency	Set Range: 0.00—400.00 Hz	Unit: 0.01 Hz	Factory Setting: 0.00
CD067	Bias Direction at Lower Frequency	Set Range: 0—1	Unit: 1	Factory Setting: 0

0: Positive direction

1: Negative direction

Bias direction means the instruction of FOR/REV rotation command. Positive bias indicates forward rotation while negative bias indicates reverse rotation. For details refer to the diagram in CD070.

CD068	Higher Analog Frequency	Set Range: 0.00—600.00 Hz	Unit: 0.01Hz	Factory Setting: 50.00
CD069	Bias Direction at Higher Frequency	Set Range: 0—1	Unit: 1	Factory Setting: 0

0: Positive direction

1: Negative direction

Bias direction means the instruction of FOR/REV rotation command. Positive bias indicates forward rotation while negative bias indicates reverse rotation. For details refer to the diagram in CD070.

CD070	Analog Negative Bias Reverse	Set Range: 0—1	Unit: 1	Factory Setting: 0
-------	------------------------------	----------------	---------	--------------------

0: Negative bias Rev is not allowable.

1: Negative bias Rev is allowable.

The parameter group is set for the measuring range and zero point of the external analog terminals and can be combined for any kind of curve to control the operation of the motor.

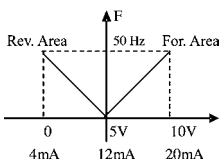

Setting: CD066=50 CD067=1 CD068=50
CD069=0 CD070=1

Note: this curve can be easily used in complicated applications in combination with other curves. When using it the instruction of FOR/REV run from external terminals is still valid. When switching, the curve will turn reverse.

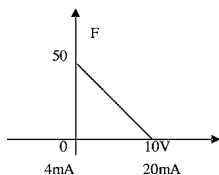

Setting: CD066=50 CD067=0 CD068=0
 CD069=0 CD070=0

Note: this curve is a kind of special application of reverse ramp setting. When using transmitter for the control of pressure, temperature and others and while the control has higher pressure and output signals but requiring the corresponding commands of stop or deceleration on the inverter this curve can satisfy the demand properly.

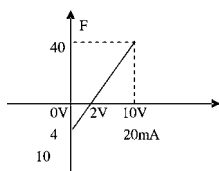

Setting: CD066=10 CD067=1 CD068=40
 CD069=0 CD070=1

Note: this method is used extensively. The user can use it flexibly.

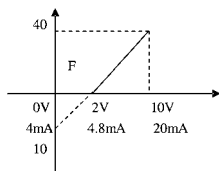

Setting: CD066=10 CD067=1 CD068=40
 CD069=0 CD070=1

Note: this curve is the extension of the above curve. 2V~10V (4.8mA~20mA) corresponds to 0Hz~40HZ; the signal of 0V~2V(4~4.8mA) is invalid. It can be used to avoid noise disturbance. In harsh environment it is better not to use signals below 1V for setting the operating frequency of the inverter.

CD071	AM Analog Output Gain
-------	-----------------------

Set Range: 0.0—100.0%

Unit: 0.1%

Factory Setting: 100.0

This parameter can be used to adjust the output voltage value of Multi-output 6 to adapt to frequency meters with different measuring range and also used to correct a frequency meter. For example, for an externally connected frequency meter with the measuring range of 0~5V, a multi-function terminal can be used to display its operating frequency. Then it can be corrected with this parameter. It can be achieved by setting CD071=50 .

CD072 UP/DOWN Function	Unit: 1	Factory Setting: 0
Set Range: 0-1		

0: Not memorized

1: Memorized

This parameter can be set for the selection of whether the values changed by the UP or DOWN shall be memorized or not after stop. The changed values whether to be memorized or not means when they are changed by UP or DOWN during operation and the inverter is restarted after stop these changed values shall be memorized or not after restart. When CD072 is set to 0, the changed value will not be memorized and when it is set to 1, the changed values will be memorized. The set values of CD000 will be memorized after restart. For the related parameters refer to CD050-CD055.

CD073 UP/DOWN Speed	Unit: 1	Factory Setting: 0
Set Range: 0-1		

0: 0.1Hz. Minimum UP/DOWN speed is 0.1Hz.

1: 0.01Hz. Minimum UP/DOWN speed is 0.01Hz.

Through the changes of this set value the UP/DOWN speed unit can be adjusted to meet the needs of different customers.

CD074 Analog Filtering Constant	Unit: 1	Factory Setting: 20
Set Range: 0-50		

The setting of this parameter is related to the analog responding speed. The higher the value of CD074 is set, the lower the analog responding speed will be.

CD075 Intermediate Counter	Unit: 1	Factory Setting: 0
Set Range: 0-65500		

Refer to CD064.

CD076 PLC Operation	Unit: 1	Factory Setting: 0
Set Range: 0—5		

0: Normal operation, i.e. the inverter is running in the normal control mode.

1: External control 4-Speeds (Refer to the function description and diagram of three terminals of high, middle and low speed in C050-C055)

2: External control multi-speeds

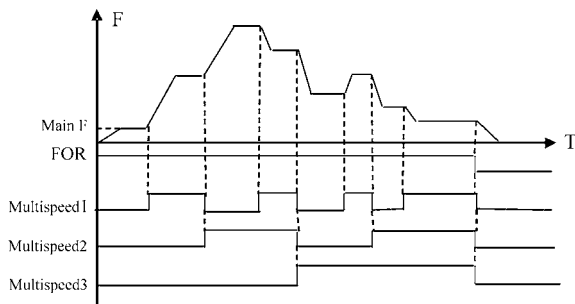

Multi-function Terminals			Results
Multi-speed 1	Multi-speed 2	Multi-speed 3	
OFF	OFF	OFF	Main frequency and frequencies are determined by CD000 or potentiometer.
ON	OFF	OFF	Multi-speed 1 and frequency are determined by CD080.
OFF	ON	OFF	Multi-speed 2 and frequency are determined by CD081.
ON	ON	OFF	Multi-speed 3 and frequency are determined by CD082.
OFF	OFF	ON	Multi-speed 4 and frequency are determined by CD083.
ON	OFF	ON	Multi-speed 5 and frequency are determined by CD084.
OFF	ON	ON	Multi-speed 6 and frequency are determined by CD085.
ON	ON	ON	Multi-speed 7 and frequency are determined by CD086.

Note:

- ① It is only valid to realize the external control 8-Speeds operation when Multi-inputs are set for Multi-speed 1, 2, 3 and CD076 is set to 2.
- ② Multi-speed 1, 2, 3 can be used to make up 7-Speeds and 8-Speeds adding the main frequency.
- ③ The frequencies of Speed Step 1 ~ Step 7 are determined by CD080~CD086.
- ④ Each ramp time is determined by the external multi-function terminal.
- ⑤ The directions of each program operation are determined by the external

multi-function terminals.

- ⑥ The main frequency can be set in two ways. One method is to set it through CD000 and another is to set it through the potentiometer. When CD034 is set to 1 the frequency of Main Frequency is set by the potentiometer. For the related parameters refer to CD000, CD034 and CD080~CD086.

3 Disturbance (Traverse function)

This is a special parameter in the chemical fiber and printing and dyeing industries to realize the traverse function. Except the commands of stop, external faults and emergency stop all other commands are not accepted at running.

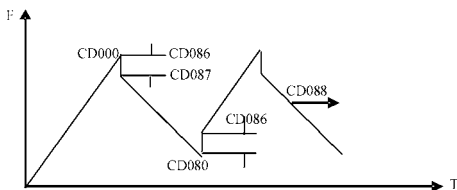

Note:

- ① The frequency at each inflection point is determined by CD000 and CD080.
- ② Skip Frequency is determined by CD086.
- ③ Running Time is determined by Timer CD087 and CD088.
- ④ The related parameters: CD000, CD080~CD088.

4 Internal control Multi-speeds

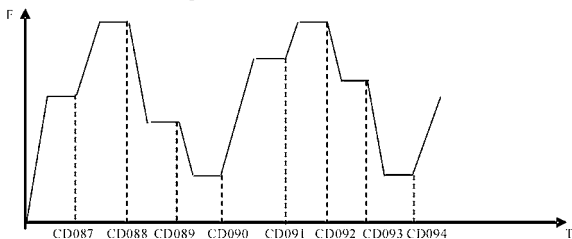

Note:

- ① Main speed and 7-speeds composes 8-speeds.
- ② The ramp time of each speed step is set by PLC Ramp Time CD079. Refer to the detail descriptions of CD079.
- ③ Running Time is set by Timer CD087~CD094. For the control steps not to

be used the timer can be set to 0.

- ④ Running direction of each speed step is determined by CD078.
- ⑤ In the internal control multi-speed operation the running time and direction are determined by the setting of internal parameters. Any switching of external time and FOR/REV rotation is invalid.

5: Drawing

This is a special parameter for the constant speed of unwinding and rewinding. By using this function the linear speed constant in certain accuracy can be realized.

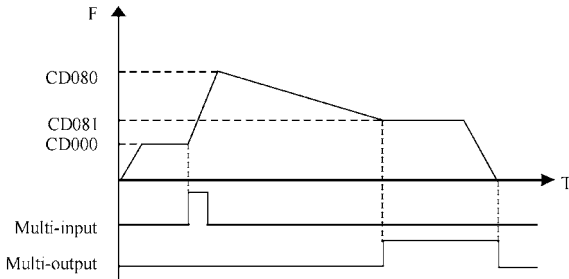

Note:

- ① Through triggering of the external multi-function terminal the drawing action begins.
- ② In implementation of the drawing action the actual running time is $T=CD087 \times t_0$.
- ③ when the drawing action is finished the inverter will run at the constant speed of CD081 and the corresponding multi-output contact will act at the same time. Until receiving the STOP command the inverter will stop running and the multi-output contact will reset.

CD077 Auto PLC	Unit: 1	Factory Setting: 0
Set Range: 0—3		

0: Stop after the program runs one cycle.

1: Cycling running

2: Stop after it runs one cycle automatically (STOP for intervention).

3: Auto running and cycling (STOP for intervention)

This parameter setting is only valid when CD076 is set to 4. For relevant parameters refer to CD000, CD076 and CD078~CD094.

Explanation:
1. Stop after the program runs one cycle.

When the command of auto program operation is given, the inverter will run with each set value of internal parameters. It will run for one cycle and then stop automatically. The inverter will not restart and run until it receives another command of operation.

2. Cycling run.

When the command of operation is given, the inverter will run in sequence with the frequency of every speed step and running time set by each of the internal parameters and will recycle. During the cycling run, except the commands of stop, external faults and emergency stop, all other commands will not be accepted.

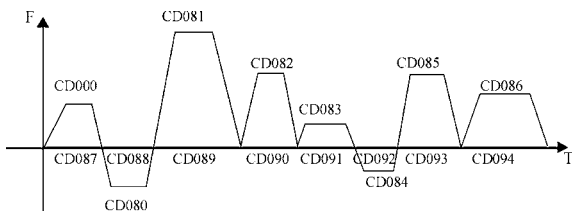
3. Stop after it runs one cycle automatically (STOP for intervention)

Note:

- ① When the command of auto program operation is given the inverter will run with each parameters. But it will stop first and then restart at changing of each step and will stop automatically after running for one cycle. The inverter will not restart and run until it receives another command of operation.
- ② The frequencies of each speed step are set by CD000 and CD080~CD086.
- ③ The running times of each speed step are set by CD087~CD094.
- ④ The running direction is set by CD078.

CD078	PLC Running Direction		
	Set Range: 0—255	Unit: 1	Factory Setting: 0

This parameter is only valid when CD076 is set to 4. This parameter setting determine the running direction of each frequency of CD080~CD086 and CD000 in the program operation. The setting method is as follows:

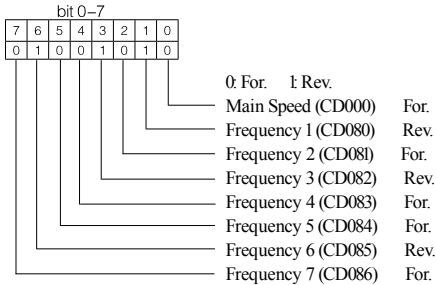
The rotation direction is set first in the binary 8 bits mode, and then converted to a decimal value for the setting of this parameter. For instance:



The parameter value 01001010 is converted to a decimal value:

$$1 \times 2^6 + 1 \times 2^3 + 1 \times 2^1 = 64 + 8 + 2 = 74$$

Then CD078=74

CD079 PLC Ramp Time	Unit: IS	Factory Setting: 0
Set Range: 0~65535		

This parameter is only valid when CD076 is set to 4.

This parameter is set to determine the ramp time values for Step 1~4 of the internal control multi-speed. The setting method is as follows:

① Determine each Ramp Time in the binary 2 bit mode

Bit1	Bit0	Ramp Time
0	0	Ramp Time 1 CD012, CD013
0	1	Ramp Time 2 CD014, CD015
1	0	Ramp Time 3 CD016, CD017
1	1	Ramp Time 4 CD018, CD019

② Determine the Ramp time of each speed step in the binary 16 bit mode

Step 8	Step 7	Step 6	Step 5	Step 4	Step 3	Step 2	Step 1
t8	t7	t6	t5	t4	t3	t2	t1
0	0	0	0	0	1	1	0
0	0	0	0	0	0	0	0
1	1	1	1	1	1	1	1

t1 Select Ramp Time 4

t2 Select Ramp Time 1

t3 Select Ramp Time 3

t4 Select Ramp Time 2

The setting value:

$$1 \times 2^0 + 1 \times 2^1 + 1 \times 2^5 + 1 \times 2^6 = 99$$

t5 Select Ramp Time 1 So CD079 is set to 99
 t6 Select Ramp Time 1 Attach: $2^0=1$ $2^1=2$ $2^2=4$ $2^3=8$
 t7 Select Ramp Time 1 $2^4=16$ $2^5=32$ $2^6=64$ $2^7=128$
 t8 Select Ramp Time 1

CD080	Frequency 2	Factory Setting	1500**
CD081	Frequency 3	Factory Setting	20.00
CD082	Frequency 4	Factory Setting	25.00
CD083	Frequency 5	Factory Setting	30.00
CD084	Frequency 6	Factory Setting	35.00
CD085	Frequency 7	Factory Setting	40.00
CD086	Frequency 8	Factory Setting	0.50
	Set Range: 0.00—400.00 Hz	Unit: 0.01 Hz	

This parameter is set in combination of the multi-inputs to select 4-speeds of external control, multi-speeds of external control or multi-speeds of internal control. For the relevant parameters refer to the description of CD076 and CD087~CD094.

CD087	Timer 1	Factory Setting	10.0**
CD088	Timer 2	Factory Setting	10.0
CD089	Timer 3	Factory Setting	0.0
CD090	Timer 4	Factory Setting	0.0
CD091	Timer 5	Factory Setting	0.0
CD092	Timer 6	Factory Setting	0.0
CD093	Timer 7	Factory Setting	0.0
CD094	Timer 8	Factory Setting	0.0
	Set Range: 0.0—6500.0S	Unit: 0.1S	

This parameter is set for the internal control multi-speeds and the running time of drawing function. For the relevant parameter refer to CD076 and CD080~CD088.

CD095	AutoPLC Memory Function		
	Set Range: 0—1	Factory Setting: 0	

0: Not memorized

1: Memorized

This parameter is set to determine whether the inverter is to realize the suspending function in AutoPLC mode. In case of CD095=1 it can memorize the status in which the inverter is running and will memorize it at stop or fail. It will continue to run when returning to normal. In case of CD095=0 it will not memorize. For specific applications refer to Example Application 10 in Appendix 1.

CD096~D109	Reserved
------------	----------

*CD110	Number of Auxiliary Pump	Set Range: 0—2	Unit: 1	Factory Setting: 0
--------	--------------------------	----------------	---------	--------------------

This parameter is set for the number of auxiliary pump. The start or stop of the auxiliary pumps is controlled by using the multi-output contacts and Auxiliary Pump 1 or Auxiliary Pump 2 is controlled through the peripheral control circuit.

*CD111	Continuous Running Time of Auxiliary Pumps	Set Range: 1—9000(min)	Unit: 1	Factory Setting: 60
--------	--	------------------------	---------	---------------------

In case of two pumps with only one pump in duty, in order to ensure each pump to work evenly, it will be switched to another pump when its running time reaches the set value of CD111.

*CD112	Interlocking Time of Auxiliary Pump	Set Range: 0.1—250.0S	Unit: 0.1	Factory Setting: 50S
--------	-------------------------------------	-----------------------	-----------	----------------------

This parameter is set to determine the interlocking time of two auxiliary pumps when switching with each other.

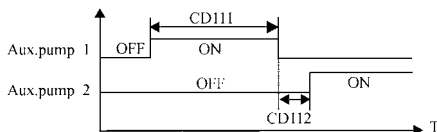

*CD113	High Speed Running Time	Set Range: 1—250S	Unit: 1	Factory Setting: 60S
--------	-------------------------	-------------------	---------	----------------------

In the application of water supply with constant pressure, when the master pump is running at the frequency of high speed (set by CD061) due to larger water volume and the high speed running time (CD113) is reached, the corresponding multi-function contacts act and the auxiliary pumps start.

*CD114	Low Speed Running Time	Set Range: 1—250S	Unit: 1	Factory Setting: 60S
--------	------------------------	-------------------	---------	----------------------

In the application of water supply with constant pressure, when the master pump is running at the frequency of low speed (set by CD062) due to smaller water volume and the low speed running time (CD114) is reached, the corresponding multi-function contacts act and the auxiliary pumps stop.

CD113 and CD114 must be used in combination of CD061, CD062 and multi-outputs. Their main function is to increase or decrease the number of auxiliary pump.

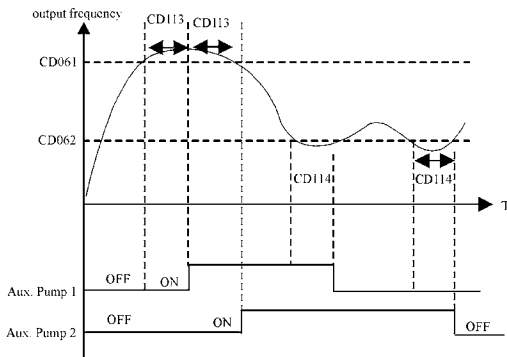

*CD115 Stopping Voltage Level Set Range: 0—150% Unit: 1 Factory Setting: 95%

This parameter is set for the voltage level of the master pump entering into sleep mode. For details refer to the following description.

*CD116 Lasting Time of Stopping Voltage Level Set Range: 1—250S Unit: 1 Factory Setting: 30S

This parameter is set for the lasting time under the stopping voltage level before entering into sleep mode. For details refer to the following description.

*CD117 Wakeup Voltage Level Set Range: 1—150% Unit: 1 Factory Setting: 80%

This parameter is set for the wakeup voltage level from sleep to wakeup.

*CD118 Sleep Frequency Set Range: 0.00—400.00 Unit: 0.01 Factory Setting: 20.00
--

This parameter is set for the lowest operating frequency entering into sleep mode.

*CD119 Lasting Time of Sleep Frequency Set Range: 1—250S Unit: 1 Factory Setting: 20S
--

This parameter is set for the lasting time to run at sleep frequency when entering into sleep mode.

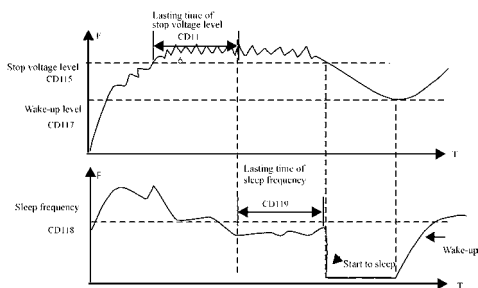

The following is the block diagram of multi pumps operation:

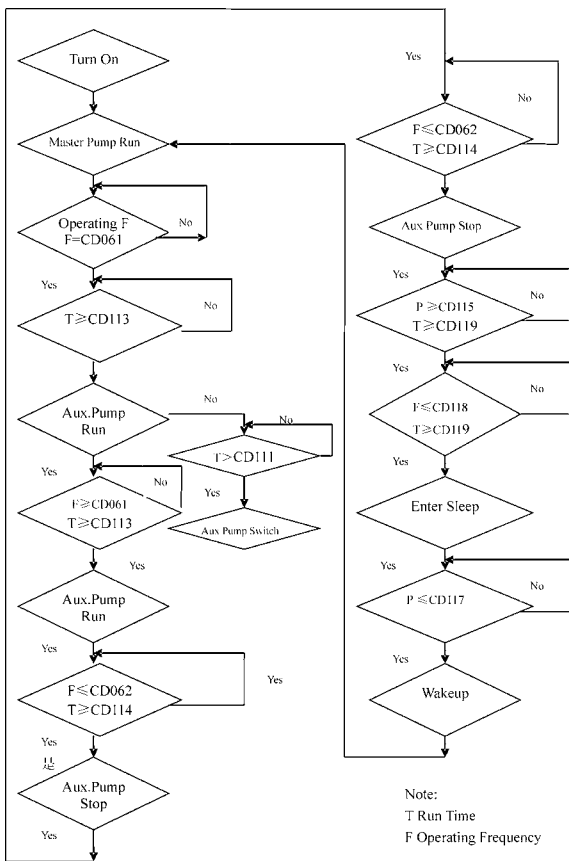

CDI20 Over-voltage Stall Prevention

Set Range: 0—1

Unit: 1

Factory Setting: 1

0: Over-voltage stall prevention invalid

1: Over-voltage stall prevention valid.

When the inverter is in deceleration, due to the effect of load inertia, the motor will produce a return energy to the inverter and cause the DC voltage of the

inverter to increase. So when the function of over-voltage stall prevention is started, if the DC voltage of the inverter becomes too high, the inverter will stop decelerating till the voltage at DC decreases below the set value, then the inverter will go on to decelerate and the ramp-down time will be extended automatically.

CDI21	Stall Prevention Level at Ramp-up		
	Set Range: 0—200%	Unit: %	Factory Setting: 150

When the inverter is in ramp-up, due to overload or too short ramp-up time, the output current of the inverter will go up quickly and exceed the set standard level. When this happens, the inverter will stop accelerating. When the current returns under its set value, the inverter will go on to accelerate.

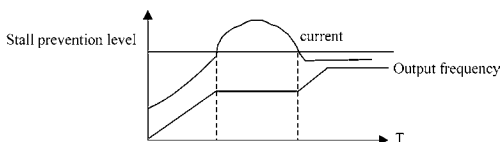

100% current is the rated current of the motor. When this parameter is set to 0, the stall prevention function is invalid.

CDI22	Stall Prevention Level at Constant Speed		
	Set Range: 0—200%	Unit: %	Factory Setting: 0

When the inverter is running at constant speed, due to load fluctuation and other reasons, the current will increase. When the current exceeds its set standard value, the inverter will lower the output frequency. When the output current returns to its normal range, the inverter will accelerate again to its set frequency.

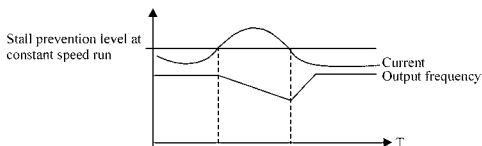

100% current is the Rated Current of the motor. When this parameter is set to 0 the stall prevention function is invalid.

CDI23	Stall Prevention Level at Deceleration		
	Set Range: 0—232%	Unit: 1	Factory Setting: 0

Refer to CDI20.

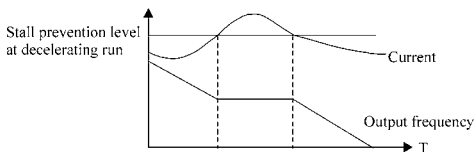

100% current is the rated current of the motor.

CDI24	Over-torque Detect Mode	Unit: 1	Factory Setting: 0
	Set Range: 0—3		

0: When reaching the frequency it starts to detect over-torque and when over-torque is detected it continues to run.

1: When reaching the frequency it starts to detect over-torque and when over-torque is detected it stop running.

2: It detects over-torque during running and when over-torque is detected it continues to run.

3: It detects over-torque during running and when over-torque is detected it stop running.

CDI25	Over-torque Detect Level	Unit: %	Factory Setting: 0
	Set Range: 0—200%		

When the output current exceeds the over-torque detection level and also exceeds half of the set time of over-torque detection (factory setting: 10s), the over-torque detection will indicate, and the corresponding multi-function alarm contact will act. When it exceeds the set time, the inverter will turn to self-protection. When this parameter is set to 0, the over-torque detection will be invalid.

CDI26	Over-torque Detect Time	Unit: 0.1s	Factory Setting: 10
	Set Range: 0.1—200s		

When the inverter detects that the output current has exceeded the motor current set value, the inverter begins to calculate the over-torque time. When the over-torque time has exceeded half of the set detect time, the corresponding multi-function output contact will act, and produce the over-torque alarm, while the inverter will keep running. When the over-torque time has exceeded the set detect time (set by CDI26), the inverter will turn to self-protection, display the fault information and stop output.

For the related parameters refer to CDI25.

CDI27	Decel. Time for Stall Prevention at Constant Speed	Factory Setting: 5.0
-------	--	----------------------

When the inverter is used for the loads of kinds of fan and pump CDI22 can be set to 120. When the current of the inverter is greater than 120% the output frequency will decrease and the current will also decrease accordingly. After the current returns to normal the frequency will return to normal slowly, so as to achieve the stall prevention function. The decreasing speed of the frequency is determined by CDI27. For the Related parameters refer to CD 122.

CDI28	Fault Restart Time	Factory Setting: 10 s
-------	--------------------	-----------------------

When the inverter is set for fault restart and if it has a fault trip with the time exceeding the set value of CDI28 the inverter will restart. When using this function pay more attention to the safety.

CDI29	Voltage Rise Time during frequency track	Factory Setting: 0.5
-------	--	----------------------

When the starting mode of the inverter is set to frequency track there is a process of voltage rise during the frequency track. When the voltage is rising rapidly the current will be higher and the tracking process will be faster. When the voltage is rising slowly the current will be lower and the tracking process will be slower. In general practice this value of CDI29 is set lower for the inverter of smaller power and set higher for the inverter of larger power.

CDI30	Rated Motor Voltage	Unit: 01V	Factory Setting: *
-------	---------------------	-----------	--------------------

It is set according to the rated voltage value of the nameplate of the motor. For the inverters of 230V class the factory setting is 220, while for the inverters of 400 V class the factory setting is 380.

CDI31	Rated Motor Current	Unit: 01A	Factory Setting: *
-------	---------------------	-----------	--------------------

It is set according to the rated value of the nameplate of the motor. This parameter can be used to restrict the output current of the inverter to prevent over-current and protect the motor. If the current of the motor has exceeded this value the inverter of AC motor will turn to self-protection.

CDI32	Motor Pole Number	Unit: 1	Factory Setting: 04
	Set Range: 02—10		

This parameter is set for the number of the motor's pole according to the nameplate of the motor.

CDI33	Rated Motor Revolution	Set Range: 0—9999	Unit: 1r/min	Factory Setting: 1440
-------	------------------------	-------------------	--------------	-----------------------

This is set according to the actual revolution of the motor. The displayed value is the same as this set value. It can be used as a monitoring parameter, which is convenient to the user. This set value corresponds to the revolution at 50Hz.

CDI34	Motor No-load Current	Set Range: 0—99	Unit: 1	Factory Setting: 40
-------	-----------------------	-----------------	---------	---------------------

The setting of motor no-load current will affect the value of slip compensation. The current is 100% of the rated current of the motor.

CDI35	Motor Slip Compensation	Set Range: 0—1000	Unit: 1	Factory Setting: 0
-------	-------------------------	-------------------	---------	--------------------

When the inverter drives the motor the slip becomes bigger due to the increase of load. This parameter can be set for slip compensation to decrease the slip and make the running speed of the motor closer to the synchronous revolution.

CDI36—CDI39	Reserved			
-------------	----------	--	--	--

CDI40	DC Braking Voltage Level	Set Range: 0.0—20.0%	Unit: 0.1%	Factory Setting: 2.0
-------	--------------------------	----------------------	------------	----------------------

This parameter is set for the DC braking voltage to the motor at start and stop. It can be adjusted for different braking voltage. When adjusting the parameter it must be increased slowly from lower value to high value until the sufficient braking torque is achieved.

The voltage at maximum frequency is 100% voltage.

CDI41	DC Braking Time at Start	Set Range: 0.0—25.0S	Unit: 0.1S	Factory Setting: 0.0
-------	--------------------------	----------------------	------------	----------------------

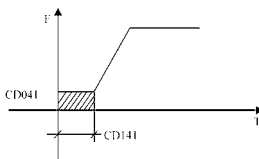

This parameter is set for DC Braking at start and the lasting time of DC Braking current to the motor. If it is set to zero it means DC braking is invalid.

DC braking at start is normally used in the application, in which the load is movable when the machine is at stop, such

as windmill. Because of the load existing before the inverter drives, the motor is often in coasting with an uncertain rotation direction. So the DC braking can be executed before starting the motor to prevent the inverter from tripping.

This setting is valid only when CD031 is set to 0. For the related parameters refer to CD031, CDI40 and CD041.

CDI42	DC Braking Time at stop	Unit: 0.1S	Factory Setting: 0.0
Set Range: 0.0—250			

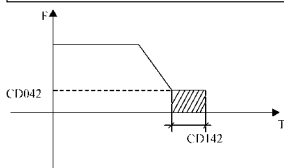

Note: When this parameter is set to any non-zero value it starts DC brake at stop and sends the DC braking time to the motor. DC braking at stop is often used for a high-level stop or positioning control. When this parameter is set to zero it closes DC braking at stop.

This setting is valid when CD032 is set to 0. For the related parameters refer to CD032, CD042 and CDI40.

CDI43	Frequency Track Time	Unit: 0.1S	Factory Setting: 2.0
Set Range: 0.1—200S			

This parameter is set as frequency track time when the inverter is started by frequency track after an external abnormality or temporary power breakdown. For starting or stopping of some large inertia load, if restarting a machine after its complete stop, it will waste much time because of its large inertia of load. But if the frequency track is started, it is not necessary to wait for the machine to come to a full stop for restart. The inverter will trace the frequency from high to low with the set frequency. After searching it will continue to accelerate to reach the set frequency.

CDI44	Current Level for Frequency Track	Unit: %	Factory Setting: 150
Set Range: 0—200%			

When the inverter is tracing the frequency this set value is taken as the level for output current. When the output current is higher than this level the inverter will decrease the frequency to restore the current below the level and then it will execute the frequency track again.

CDI45	Restart after Instantaneous Stop	Unit: 1	Factory Setting: 0
Set Range: 0—1			

0: Invalid, i.e. the inverter will not restart after an instantaneous power breakdown.

1: Start by frequency track. Refer to CDI43.

CDI46	Allowable Power-Breakdown Time	Unit: 0.1S	Factory Setting: 0.5
Set Range: 0.1—50S			

This parameter is set for the maximum allowable power failure time. If exceeding the set time the inverter will continue to stop output after power on. To restart the inverter it needs to follow the general starting procedures.

CDI47	Number of Abnormal Restart		
	Set Range: 00—10	Unit: 1	Factory Setting: 00

After the abnormal conditions (such as over-current and over-voltage) happens the inverter will automatically reset and restart. If the starting mode is set to normal mode it will start according to the normal procedures. If it is set to start by frequency track it will start in the frequency track mode. After starting it will restore the set number again if there is no more abnormality happened within 60 seconds. If there is still any error and it reaches the set number the inverter will stop output. It can only be started after reset. When CDI47 is set to zero the inverter will not carry out the functions of automatic reset and restart.

CDI48	Auto Voltage Regulation		
	Set Range: 0—1	Unit: 1	Factory Setting: 1

0: Invalid

1: Valid

When the input power is not stable and if the voltage is too high the operation of the motor with the power exceeding the rated voltage will cause increase of the temperature of the motor, damage of its insulation and unstable output torque. This auto voltage regulation can automatically stabilize the output voltage within the rated voltage range of the motor under the condition of unstable output power supply

When this function is set to invalid the output voltage will fluctuate.

CDI49	Auto Energy Saving		
	Set Range: 0.0—20.0%	Unit: 0.1%	Factory Setting: 0.0

When it is set to zero this function is invalid. When Auto energy saving function is started the inverter will run at the full voltage during ramp-up or -down. During the operation at constant speed the inverter can automatically calculate the optimum voltage value according to the power of load and supply power to the load to achieve the goal of energy saving.

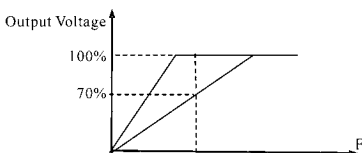

Auto energy saving can reduce the normal output voltage by max 30%. For the load with frequent changes or closing to full load, this function is not suitable.

*CD150 Proportional Constant (P)	**
Set Range: 0~1000.0%	Unit: 0.1% Factory Setting: 1000%

This proportional constant is set for the error value gain. In case of I=0, D=0, it is only for proportional control.

*CD151 Integral Time (I)	**
Set Range: 0.1s~1000.0s	Unit: 0.1s Factory Setting: 50s

The integral time (I) is set for the responding speed for PID. The larger the I value is set the slower the responding speed will be. To the contrary, if the responding speed is quick but the integral time value is set too small, it will cause oscillation.

*CD152 Differential Time (D)	**
Set Range: 0.00~100.0s	Unit: 0.01s Factory Setting: 0

This differential time (D) is set for the depression operation of PID. The larger the D value is, the more obvious the depression operation will be. When D is set to zero, this function is invalid.

*CD153 Target Value	**
Set Range: 0.0~100.0%	Unit: 1% Factory Setting: *

This target value can be set through external voltage signal or the digital operator. 100% target value is corresponding to the analog frequency at +10V.

PID closed-loop control is usually used in the process control with physical quantity not changing fast, such as the controls of pressure and temperature, etc. The feedback signal is usually taken from temperature transmitter, or pressure transmitter, etc. Under PID control, the feedback signal input path is the analog current signal of 4-20mA.

PID closed-loop control is valid when Multi-input PID is started.

PID Control Block Diagram:

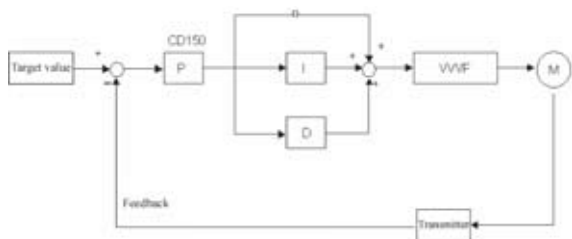

General operating methods of PID control:

- (1) Choose the correct transmitter (with the output specification of standard current signal 4-20mA).
- (2) Set the right target value.
- (3) If the output does not have oscillation, increase the proportional constant (P).
- (4) If the output does not have oscillation, decrease the integral time (Ti).
- (5) If the output does not have oscillation, increase the differential time (Td).
- (6) Concrete applications can be referred to the example application descriptions in Appendix 1.

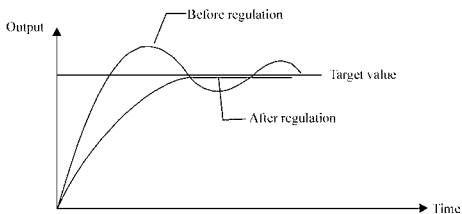

1. Suppress the Over Output

- a: Decrease the differential time (D value)
- b: Increase the integral time (I value)

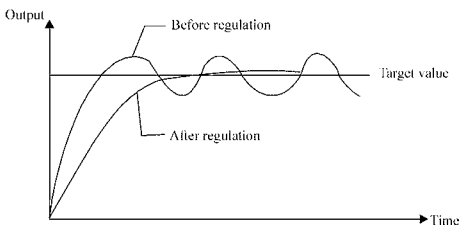

2. Suppress the oscillation

- a: Decrease the differential time (D value) or set it to zero.
- b: Decrease Proportional Constant (P value)

*CDI54 PID Target Value	**
Set Range: 0—1	Unit: Factory Setting: 0

The target value can be set through the selection of the panel or external analog. The external analog is 0~10V signal or given by the potentiometer.

When CDI54=0, the target value of PID is the value set by CDI53.

When CDI54=1, the target value of PID is the value of the external analog 0-10V (corresponding to 0-100%), the setting of CDI53 is invalid.

*CDI55	PID Upper Limit		**
	Set Range: 0—100%	Unit:	Factory Setting: 100%

When PID feedback value is more than the set value of CDI55 the corresponding multi-output will act and the inverter will not stop.

*CDI56	PID Lower Limit		**
	Set Range: 0—100%	Unit:	Factory Setting: 0%

When PID feedback value is less than the set value of CDI56 the corresponding multi-output will act and the inverter will not stop.

CDI57~CDI59	Reserved
-------------	----------

CDI60	Communication Addresses		
	Set Range: 0—250	Unit:	Factory Setting: 0

When the inverter is set for RS-485 Communication interface control, each of the inverters will be set for its individual identification number through CDI60.
 00: No communication function.
 01~250: Address for the inverters

CDI61	Communication Baud Rate		
	Set Range: 0—3	Unit:	Factory Setting: 1

0: 4800 b/s 1: 9600 b/s 2: 19200 b/s 3: 38400 b/s

CDI62	Communication Data Method		
	Set Range:	Unit:	Factory Setting: 0

0: 8N1 For ASCII 1: 8E1 For ASCII 2: 8O1 For ASCII
 3: 8N1 For RTU 4: 8E1 For RTU 5: 8O1 For RTU

CDI63~CDI66	Reserved
-------------	----------

HOLIP MODBUS Communication Protocol

When using the RS485 communication interface, each of the inverters must be set for its own address so that the computer can use this individual address to carry out the control.

! The communication protocol has two kinds of control mode:

- (1) RTU (Remote Terminal Unit) mode
- (2) ASCII (American Standard Code for information interchange) mode

Information of codes:

RTU mode: Each of 8-bit data is composed of two 4-bit (hexadecimal), for

example: 64H

ASCII mode: Each of 8-bit data is composed of two ASCII byte, for example: One 1-bit data 64H (hexadecimal) is composed of ASCII byte "64", included "6" (36H) and "4" (34H).

Byte	0	1	2	3	4	5	6	7
ASCII code	30H	31H	32H	33H	34H	35H	36H	37H

Byte	8	9	A	B	C	D	E	F
ASCII code	38H	39H	41H	42H	43H	44H	45H	46H

2: Communication Data Method

(1) 8N1 For ASCII C DI62=0

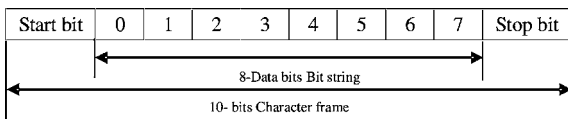

(2) 8E1 For ASCII C DI62=1

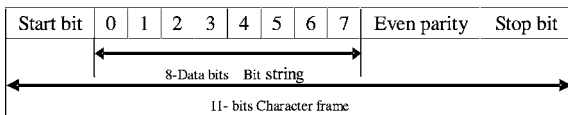

(3) 8O1 For ASCII C DI62=2

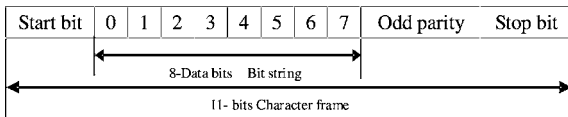

(4) 8N1 For RTU C DI62=3

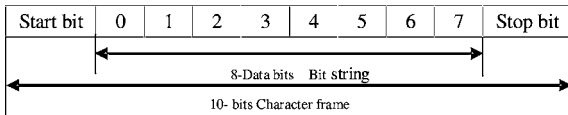

(5) 8E1 For RTU C DI62=4

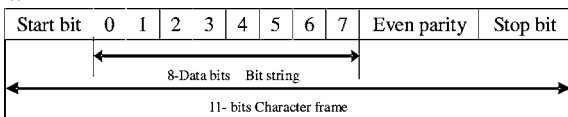

(6) 8O1 For RTU C DI62=5

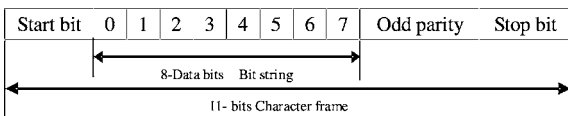

3 Communication Document Formats

3.1 ASCII Mode

Communication Document Forms

STX “:” (3AH)	ADDR	FUNC	LEN	DATA (n-1) ... DATA ₀	CRC	END CR(0DH) LF(0AH)
---------------------	------	------	-----	---	-----	---------------------------

(1) STX: Starting unit “:” (3AH)

(2) ADDR communication address, 8-bit data is composed of two ASCII byte.

00: Broadcast mode is MODBUS

01~250: Address of the corresponding inverters.

(3) FUNC: Function code 8-bit data is composed of two ASCII byte.

01: FUNC READ, Read the data of function code

02: FUNC WRIT, write the data of function code

03: Write control data

04: Read control status data

05: Write inverter frequency data

06: Reserved

07: Reserved

08: Loop test

a: Read function code data

Format:

ADDR 01 LEN FUNC Data

ADDR=0 means no answer

ADDR≠0 means a reply from inverter of this address

When inverter reply normal, the format as follows □

ADDR 01 LEN FUNC Data

If DATA is one word, the LEN=3, If DATA is one byte, the LEN=2.

When inverter has no this function code or reply no effect, the format as follows:

ADDR 8IH 0I FUNC

b: Write function code data

Format:

ADDR 02 LEN FUNC Data

ADDR=0 for broadcast, it write to all inverter, but no reply.

ADDR≠0, set data and reply from inverter of this address.

When the setting is incorrect or the inverter does not have this function, the format returned is as follows:

ADDR 8IH 0I FUNC

c: Control commands

Format:

ADDR 03 LEN CNTR

ADDR=0 for broadcast, it write to all inverter, but no reply

ADDR≠0, reply and return.

CNTR

7	6	5	4	3	2	1	0
jogr	jogf	jog	r/f	stop	rev	for	run

When the setting is correct it will return to present control status.

Format: ADDR 03 LEN CNST

CNST

7	6	5	4	3	2	1	0
Track start	Braking	r/f	jogging	running	r/f	jog	run

When the check is not correct,

ADDR 83H 0I CNST

d: Read status value

Format:

ADDR 04 0I CFG

ADDR=0, no reply

ADDR≠0, reply.

CFG=0~7, reply single data

0: Set F 1: Out F 2: Out A 3: RoTT

4: DCV 5: ACV 6: Cont 7: Tmp

For example: read agreed frequency

Send: 01 04 03 00 CRC

Return: 01 04 03 13 88 CRC

In which, 13 88 are data

13 for high order, while 88 for low order.

(4) LEN: data length, It means the length of D(n-1) . . D0, Length set: when one

word, LEN=3, when one byte or <byte, LEN=2.

(5) DATA: <Data characters> data content. 2n ASCII compose n bytes, it have fifty ASC II at most.

(6) LRC : longitudinal redundancy check

ASCII mode: Get LRC methods is that add ADDR to the last data, if the result is more than 256, then the result subtract 256 until the result is less than 256 (if the result is 128H, take 28H), then 100H subtract the result get LRC.

(7) For example: write 30.00Hz to inverter of 01 (write to CD000)

STX	ADDR	FUNC	LEN	DATA	LRC	END
“3”	“0” “1”	“0” “2”	“0” “3”	“0” “0” “0” “B” “B” “8”	“3” “7”	“CR” “LF”
3AH	30H 31H	30H 32H	30H 33H	30H 30H 30H 42H 42H 38H	33H 37H	0DH 0AH

Calculate LRC: 01H+02H+03H+00H+0BH+B8H=C9H

C9H subtracted from 100H: 37H

So the sent data is following: 3AH 30H 31H 30H 32H 30H 33H 30H 30H 30H
42H 42H 38H 33H 37H 0DH 0AH

3.2 RTU Mode

Quiet	ADDR	FUNC	LEN	D _(n-1) ~D ₍₀₎	CRC	Quiet
>50ms						>50ms

(1) Quiet: the time of no data is more than 50 ms

(2) ADDR: Communication address, 8-bit data

(3) FUNC: Function code, 8-bit data, refer to 3.1-3

(4) LEN: Data length, the length of D_{n-1}~D₀

(5) DATA: data content, n*8-bit

(6) LRC: Longitudinal Redundancy Check

RTU mode: get CRC cyclical Redundancy Check.

The CRC calculation method is following:

(1) make a 16-bit register and set value 0FFFFH (call CRC register)

(2) done first byte of data Exclusive OR with low byte of 16-bit CRC register and save the result to CRC register

(3) done 1 bit right shift with CRC register and fill zero to left bit, then check low bit of CRC register.

(4) if the low bit is zero, then do repeat step 3, else CRC register do Exclusive OR with 0A001H.

(5) done repeat step 3 and 4, until CRC register done right shift 8 times, then the byte is fully done.

(6) done repeat step 2 to 5 for the next byte of data, until process completely

all data. The last data of CRC register is CRC value. When send CRC value in command data, low bytes must change the sequence with high bytes, i.e. low bytes will be sent first.

(7) Example 1: Write 30.00Hz to inverter of 01

Command data

ADDR	FUNC	LEN	DATA		CRC
01H	02H	03H	00H 0BH B8H	7FH 0CH	

Sent data: 01H 02H 03H 00H 0BH B8H 7FH 0CH

(8) Example 2:

The following is that get CRC value with C language. The function has two parameters

Unsigned char data ← the point of data buffer

Unsigned char length ← number of data buffer

This function will send back the CRC value with unsigned integer format.

Unsigned int crc_chk (unsigned char data, unsigned char length)

```

{
int j;
unsigned int reg_crc=0xffff;
while (length--){
reg_crc^=*data++;
for(j=0;j<8;j++){
if((reg_crc&0x01)/=*LSB(b0)=1*/
reg_crc=(reg_crc>>1)^0xa00;
}else{
reg_crc=reg_crc>>1;
}
}
}
return reg_crc;
}

```

CD167	Display Items		
	Set Range: 0—3l	Unit: 1	Factory Setting: 0

This parameter is only valid when Bit 2 is set to 1 in CD168. For the details refer to CD168.

0: Inverter Temperature

1: Counter Value

2: PID Target Value

3: PID Feedback Value

4: Present running time of power up (Unit: Hour)

5: Total running time of power up (Unit: Hour)

CDI68	Display Items Open	Unit: 1	Factory Setting: 0
Set Range: 0—7			

This parameter is set for selection of displaying of DC voltage, AC voltage and other items so that the customer can monitor and view them in sequence through the switch key.

It can be set first in the binary 3 bits mode, and then converted to a decimal value.

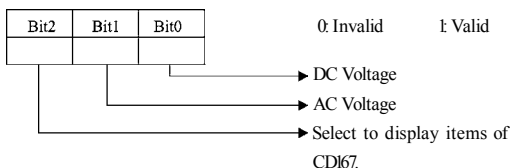

In the contents displayed the factory setting is to show output frequency, set frequency, output current and output revolution through the switch key. If it is necessary to view and monitor other items they can be set through CDI67 and CDI68.

CDI69	Voltage Rating of Inverter	Unit: IV	Factory Setting: *
-------	----------------------------	----------	--------------------

Factory setting is depending on the model. It can be observed, but not set.

CDI70	Rated Current of Inverter	Unit: IA	Factory Setting: *
-------	---------------------------	----------	--------------------

It is depending on the model and can't be changed.

CDI71	Software Version	Factory Setting: *
-------	------------------	--------------------

It can be observed, but not set.

CDI72	Fault Record 1	Factory Setting: ————
CDI73	Fault Record 2	Factory Setting: ————
CDI74	Fault Record 3	Factory Setting: ————
CDI75	Fault Record 4	Factory Setting: ————

When it has no fault record it shows ———. After access to this parameter the fault display can be checked.

CDI76	Fault Clear		**
	Set Range: 00—10	Unit: 1	Factory Setting: 00

01 is for fault clear. Others have no function.

CDI77	Inverter Model		
	Set Range: 0—1	Unit: 1	Factory Setting: 0

0: Constant torque 1: For kinds of fan. It can be observed, but not changed.

CDI78	Inverter Frequency Standard	Unit: 1	Factory Setting: *
-------	-----------------------------	---------	--------------------

0: 50Hz 1: 60Hz It is factory setting. It can be observed, but not set.

CDI79	Manufacture date		Factory Setting: *
-------	------------------	--	--------------------

5	4	3	2	1
---	---	---	---	---

It is factory setting. It can be observed, but not set.



CDI80	Serial No.		Factory Setting: *
-------	------------	--	--------------------

It is factory setting. It can be observed, but not set.

CDI81—CD250	Reserved		
-------------	----------	--	--

Note:

* means the said parameter has a variety of set values or should be set specifically according to concrete conditions.

** means the said parameter can be set during the operation.

X. Care & Maintenance, Fault Information and Troubleshooting

Periodical maintenances and inspections will keep your inverter in its normal state for long time.

1. Precautions about Inspection and Maintenance

- Be sure to turn off the power supply to the inverter (R.S.T) first before the inspection and maintenance.
- After confirming the main circuit power supply has been turned off and the display has disappeared, wait until the internal indicator lamp for high voltage goes out before performing the inspection and maintenance.
- During the inspection, do not pull out or wrongly distribute the internal power supply, wires and cables. Otherwise it will cause malfunction or damage to the inverter.
- Do not leave any screw or other part inside the inverter during the installation, or it will result in the short circuit of circuit board.
- Keep the inverter clean, free from dust, oil mist and moisture after the installation.

2. Periodical Inspection and Maintenance items

- Check whether the power supply voltage conforms to the rated voltage of the inverter.
(Pay special attention to that whether there is any damage on the power supply wires and the motor.)
- Check whether the wiring terminals and the connectors are tight
(Check whether the power supply wires and terminal connection wires have any broken strand).
- Check whether there is dust, iron filings or corrosive fluid in the inverter.
- Measuring the insulation impedance of the inverter is forbidden.
- Examine the output voltage, output current and output frequency of the inverter.
(The measuring results should not have too big difference.)
- Check whether the ambient temperature of the inverter is between -5°C and 40°C and whether the installation environment has good ventilation.
- Check whether the humidity is kept below 90% (without condensation).
- Check whether the motor makes unusual noises or abnormal vibration in running.
(The inverter should not be installed in a place with high vibration.)
- Please make periodical cleaning of vent holes.

3. Fault Indication and Troubleshooting

The inverter of HLP series is relatively perfective with the protection functions of overload, inter-phase short circuit, earth short circuit, under-voltage, overheating and over-current, etc. When a protection function happens with the inverter please check the reasons of faults according to the information listed in the table below. The inverter can be restarted after the disposal. If the fault cannot be disposed please contact the local distributor.

Fault Display	Fault Contents & Description	Disposal methods
E.O.C.A	Over-current during ramp-up	1: Check whether the motor has got short circuit or partial short circuit and whether the insulation of output wire is good. 2: Extend the ramp-up time. 3: The configuration of the inverter is not reasonable. The inverter's capacity should be increased. 4: Decrease the torque and increase the set value.
E.O.C.n	Over-current at constant speed	1: Check whether the motor has got short circuit and whether the insulation of the output wires is good. 2: Check whether the motor is blocked and whether there is a sudden change of mechanical load. 3: Check whether the inverter's capacity is too small and increase its capacity. 4: Check whether there is a sudden change in the power supply voltage.
E.O.C.d	Over-current at decel	1: Check whether the insulation of the output wires is good and whether the motor has got short circuit. 2: Extend the Ramp-down Time.
E.O.C.S	Over-current at stop	3: Replace it with an inverter of larger capacity. 4: DC braking is too high. Decrease DC braking. 5: The inverter has failure. Please send it to the factory for repair.
E.G.F.S E.G.F.a E.G.F.n E.G.F.d	Short circuit to earth	1: Check whether the connection wire of the motor has got short circuit. 2: Check whether the insulation of the output wires is good. 3: Please send it for repair.

Fault Display	Fault Contents & Description	Disposal methods
E.ou.S E.ou.a E.ou.n E.ou.d	Over-voltage at stop Over-voltage at accel Over-voltage at constant speed Over-voltage at decel	1: Extend the Ramp-down Time or add a braking resistor. 2: Improve the mains supply voltage and check whether there is any sudden change in the voltage.
E.Lu.s E.Lu.A E.Lu.n E.Lu.d	Low voltage	1: Check whether the input voltage is normal. 2: Check whether there is sudden change in load. 3: Check whether there is any phase missing.
E.OHS E.OHA E.OH.n E.OH.d	Overheat of inverter	1: Check whether the fan is blocked and whether there is any foreign matter stuck in the cooling fins. 2: Check whether the ambient temperature is normal. 3: Check whether there is enough space for ventilation and good air convection.
E.OLA E.OL.n E.OL.d	Inverter overload 150% Per minute	1: Check whether the capacity of the inverter is lower. Otherwise it should be increased. 2: Check whether there is any jamming in the mechanical load. 3: The setting of V/F curve is bad. Set it again.
E.OA.A E.OA.n E.OA.d	Motor overload 150% Per minute	1: Check whether there is any sudden change in the mechanical load. 2: The equipped motor is too small. 3: The motor is hot and the insulation becomes bad. 4: Check whether the voltage has big fluctuation. 5: Check whether there is any phase missing. 6: The mechanical load is increased.
E.OTA E.OT.n E.OT.d	Motor over-torque	1: Check whether there is any fluctuation in the mechanical load. 2: Check whether the equipped motor is smaller.
E.bSA E.bSn E.bSd E.bSS	No feedback from auxiliary coil of the electromagnetic contactor	Please contact the factory.

Fault Display	Fault Contents & Description	Disposal methods
E.bTA E.bTn E.bTd	Braking transistor damage	Please send it for repair.
E.ECS E.ECn E.ECd E.ECA	CPU fault	Please contact the factory.
E.EES E.EEn E.EEd E.EEA	E2Prom fault	Please contact the factory.

Er	External interferences	Isolate the interference source
ES	Emergency Stop	In Emergency Stop
20	4-20mA wire broken	Join the broken wires
Pr	Setting error	Correct the setting
DCb	DC braking status	In DC braking

Note: (1) Fault Code Form as follows:

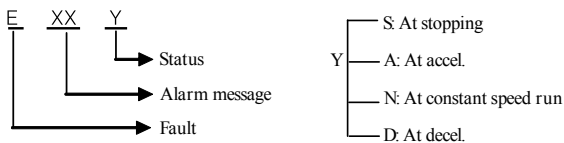

(2) Code Comparison Table:

A	B	C	D	E	F	G	H	O	S	N	L	T	P	R	U	2
A	b	c	d	e	f	g	h	0	s	n	l	t	p	r	u	2

4. Faults and Analysis

- (1) When RUN key is pressed, the motor does not run.
- The setting of operation mode is wrong, i.e., under the operation mode of external control terminals, the inverter is started by the digital operator or under the operation mode of the digital operator it is started by the external control terminals.

- 2) The frequency reference is too low or not set.
- 3) The peripheral wiring is wrong. For example, the setting of wiring of two-wire system and three-wire system and other related parameters have errors.
- 4) The setting of multi-function terminals is wrong (in the external control).
- 5) The inverter is in the fault protection.
- 6) The motor fails.
- 7) The inverter fails.

(2) The parameters cannot be set.

- 1) Password locks. Please decrypt it first before resetting.
- 2) The inverter is in running.
- 3) The connection of the connecting parts is abnormal. The communication of the digital operator is abnormal. Take out the operator after power-off and then mount it again for a trial.

(3) The motor cannot rotate reverse.

Reverse rotation is disabled.

(4) The motor rotates in the opposite direction.

The output line is wrongly connected. Please change any two lines of UVW over.

(5) The deceleration of the motor is too slow.

- 1) The setting of Ramp-down Time is too long. Decrease Ramp-down Time.
- 2) Add a braking resistor.
- 3) Add a DC brake.

(6) Over-heat of the motor

- 1) The load is too large. The actual torque has exceeded the rated torque of the motor. It is recommended to increase the capacity of the motor.
- 2) The ambient temperature is too high. In a place with higher temperature the motor will be burn out. Please decrease the temperature around the motor.
- 3) The phase to phase withstand voltage of the motor is insufficient.

The switch actions of the inverter will make the winding coil of the motor produce shock wave. Typically the maximum shock voltage will reach 3 times that of input power of the inverter. Please select a motor with higher phase to phase withstand voltage against shock than the maximum shock voltage.

(7) The starting of the inverter interferes other control devices

- 1) Decrease the carrier frequency and reduce the number of actions of internal switches.

- 2) Install a noise filter at the power input of the inverter.
 - 3) Install a noise filter at the output of the inverter.
 - 4) Make correct grounding for the inverter and the motor.
 - 5) Use metal conduit to tube the cable to shield it.
 - 6) Make separate wiring for the main circuit wires and control wires.
- (8) When the fan starts the inverter detected an over-current stall.
- 1) At start the fan rotates idly. Please set it for DC braking at start.
 - 2) When DC braking at start has been set increase the DC braking value.
- (9) The machine has the noise of vibration or roar
- 1) The vibration frequency of mechanical system resonates with the carrier.
Adjust the carrier to avoid the point of resonance.
 - 2) The vibration frequency of mechanical system resonates with the output frequency of the inverter.
 - a. Set it for skip function to avoid the point of resonance.
 - b. Put rubber vibration isolator on the base plate of motor.

XI. Selection of Peripheral Devices and Disposition

1. Options

Description	Functions
NFB or Ground fault interrupter for wire connection	Protect the wiring of the inverter. Be sure to install a breaker at the power. Please select a ground fault circuit interrupter against high-order harmonics.
Electromagnetic contactor	In order to prevent the braking resistor from burning out, please add an electromagnetic contactor and connect a surge absorber to the coil when using it.
Surge absorber	Absorb the switching surge current from the electromagnetic contactor and control relays.
Isolating transformer	Its function of isolating the input and output of the inverter is effective to reduce the interference to other electric devices.
DC reactor	Improve the input power factor of the inverter.
AC reactor	Improve the input power factor of the inverter and prevent the shock of surge voltage.
Braking resistor, braking unit	Consume the regenerating energy of the motor and shorten the ramp-down time.

1) Leakage switch

There is earth static capacity inside of the inverter and the motor as well as the input and output leads. Due to higher carrier frequency of the inverter the inverter has higher earth leakage current, especially for the inverters of large capacity series. When using a leakage switch it may sometimes result in the error action of the protective circuit. So when using a leakage switch attention should be paid to its selection and the proper reduction of carrier frequency and shortening the leads, etc.

2) AC reactors

An AC reactor can constrict the high-order harmonic of input current of the inverter to improve its input power factor and prevent the shock of surge. It is recommended to use an input AC reactor under the following circumstances:

- a□ Three-phase power supply is in unbalance.
- b□ Any equipment with thyristor or power factor compensation unit with switching control is connected to the same power supply.

3) DC reactors

It is necessary to install a DC reactor when the capacity of power supply is more than 1000 KVA or the mains power capacity is higher than the rated capacity of the inverter. A DC reactor is also needed for the case with higher demand on the improvement of power factor of power supply. This DC reactor can be used together with an AC reactor to achieve the obvious effect of decreasing high-order harmonic at input. If it is necessary to install a DC reactor please contact the local distributor.

2. Disposition

1) DC Reactors Disposition

Inverter Model	Matched Power (W)	Rated Current (A)	Inductance (mH)
DCL-37	37	100	0.7
DCL-45	45	120	0.58
DCL-55	55	146	0.47
DCL-75	75	200	0.35
DCL-90	90	238	0.29
DCL-110	110	291	0.24
DCL-132	132	326	0.215
DCL-160	160	395	0.177
DCL-200	200	494	0.142
DCL-220	220	557	0.126
DCL-280	280	700	0.10
DCL-300	300	800	0.08
DCL-315	315	800	0.08
DCL-345	345	660	0.07
DCL-375	375	715	0.064
DCL-400	400	765	0.058
DCL-415	415	795	0.053

Connection

- ① Remove the jumpers of P and P1 terminals.
- ② Connect DC reactor to Terminals P and P1 as shown in the following diagram:

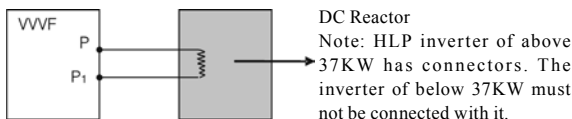

The function of DC reactor is to restrict the AC component stacked with DC reactor to a specified value to suppress the mains harmonics and improve the power factor of the inverter.

2) AC Reactors Disposition

Inverter Model	Matched Power (W)	Rated Current (A)	Inductance (mH)
HKSG2-24	11	24	0.52
HKSG2-34	15	34	0.397
HKSG2-38	18.5	38	0.352
HKSG2-50	22	50	0.26
HKSG2-60	30	60	0.24
HKSG2-75	37	75	0.235
HKSG2-91	45	91	0.17
HKSG2-112	55	112	0.16
HKSG2-150	75	150	0.112
HKSG2-180	90	180	0.10
HKSG2-220	110	220	0.09
HKSG2-265	132	265	0.08
HKSG2-300	160	300	0.07
HKSG2-360	200 (185)	360	0.06
HKSG2-400	220	400	0.05
HKSG2-560	280	560	0.03
HKSG2-640	315	640	0.0215
HKSG2-700	345	700	0.019
HKSG2-750	375	750	0.017
HKSG2-800	400	800	0.015
HKSG2-860	415	860	0.012

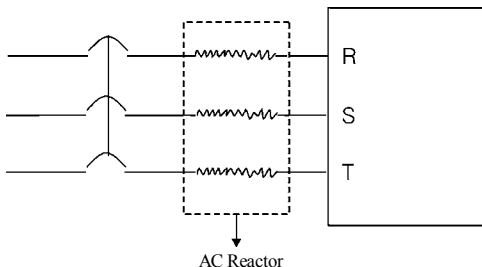

The incoming reactor is also named shift-changing reactor and it is used for the incoming wire of the mains with AC flowing inside. Its function is to suppress the harmonics of the inverter feedback to the mains.

Inverter Model	Braking resistor Specification		Braking torque 10%ED	Special Motor KW
	W	Ω		
HLP A00D423C	80	200	125	0.4
HLP A00D7523C	100	200	125	0.75
HLP A01D523C	300	100	125	1.5
HLP A02D223C	300	70	125	2.2
HLP A0D7543C	80	750	125	0.75
HLP A01D543C	300	400	125	1.5
HLP A02D243C	300	250	125	2.2
HLP A03D743B	400	150	125	3.7
HLP A05D543B	500	100	125	5.5
HLP A07D543B	1000	75	125	7.5
HLP A001143B	1000	50	125	11
HLP A001543B	1500	40	125	15
HLP A18D543B	4800	32	125	18.5
HLP A002243B	4800	27.2	125	22
HLP A003043B	6000	20	125	30
HLP A003743B	9600	16	125	37
HLP A004543B	9600	13.6	125	45
HLP A005543B	12000	20/2	125	55
HLP A007543B	18000	13.6/2	125	75
HLP A009043B	18000	20/3	125	90
HLP A011043B	18000	20/3	125	110
HLP A013243B	24000	20/4	125	132

Inverter Model	Braking resistor Specification		Braking torque 10%ED	Special Motor KW
	W	Ω		
HLP A016043B	36000	13.6/4	125	160
HLP A018543B	45000	13.6/5	125	185
HLP A020043B	45000	13.6/5	125	200
HLP A022043B	48000	13.6/5	125	220
HLP A025043B	48000	13.6/5	125	250
HLP A028043B	57600	13.6/6	125	280
HLP A030043B	57600	13.6/6	125	300

For the braking resistor used for the machines of above 315 KW please contact the factory.

For the inverter of above 11KW to realize quick brake a braking unit must be added.

Note:

- 1: Please select the resistor value and operating frequency given by our company.
- 2: If it causes any damage to the inverter and other devices due to the use of any braking resistor and braking model group not supplied by our company, we will take no responsibility.
- 3: Be sure to consider the safety and ignitability of the environment when installing a braking resistor. The distance to the inverter should be at least 100 mm.
- 4: If it is necessary to change the resistor value and power value, please contact the local distributor.
- 5: In need of a braking resistor a separate order must be placed. Please contact the local distributor for details.

XII. Appendices

Appendix 1: Simple Examples of Application

1. Disturbance Function (Generation of Triangle Wave)

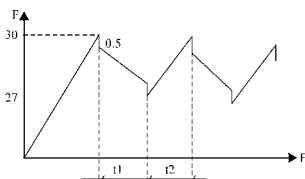

A curve as in left is generated.

Parameter setting:

CD076=3 CD000=30

CD080=27 CD086=0.5

CD087=10 CD088=10

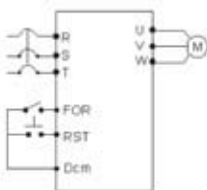
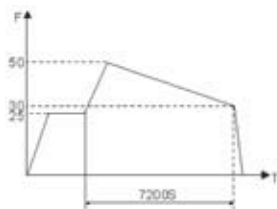

2. Drawing Function

Parameter setting:

CD076=5 CD000=25 CD080=50 CD081=30

CD087=720 CD052=29 CD033=1

Note:

- ① When triggered by external multi-function terminals (as RST in the diagram), the drawing action starts to be implemented.
- ② In implementation of drawing action the running time $T=CD087 \times 10S$
- ③ FOR/REV Rotation of the Motor Controlled by One Potentiometer.

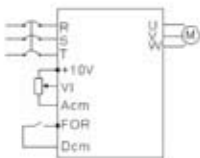
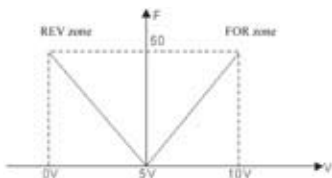

Parameter setting:

CD033=1 CD034=1 CD066=50 CD068=50

CD067=1 CD069=0 CD070=1

4. Internal Control 8 Speed Run

A curve as shown in the following diagram is established. Internal control 8-speed run will stop after running for one cycle.

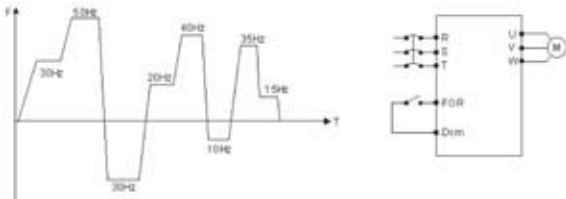

Parameter setting:

CD076=4 CD000=30 CD080=50 CD081=30

CD082=20 CD083=40 CD084=10 CD085=35

CD086=15 CD078=36 CD077=0 CD012=5

CD013=5 CD033=1 CD079=0 CD050=1

CD087-CD094=15

Note:

1. The running time of each speed is set by CD087-CD094=15.
2. Auto cycling CD077=1
3. After the running command is given it will run with the set curve for one cycle and stop.

5. Linkage of Multi Pumps

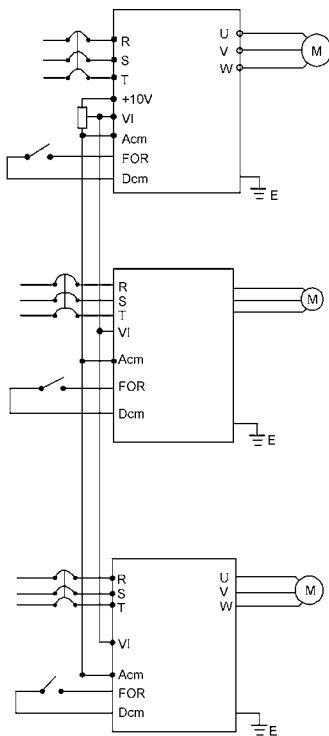

Attention:

① The frequency of the main inverter can be set by the potentiometer.

② The proportion relation of the inverters can be adjusted by CD068.

For example: For $F_{\text{Inverter1}} : F_{\text{Inverter2}} : F_{\text{Inverter3}} = 1 : 2 : 3$ the parameters of CD068 can be adjusted.

Frequency 1 : CD068=50, Frequency 2 : CD068=100, Frequency 3 : CD068=150. In case of the analog of 10V, the corresponding frequencies are respectively 50Hz, 100Hz, 150Hz with the proportion of 1 : 2 : 3.

③ For easy operation and adjustment a fine tuning potentiometer can be added. For concrete application please consult.

6. Run by Switching of Power Frequency/Variable Frequency

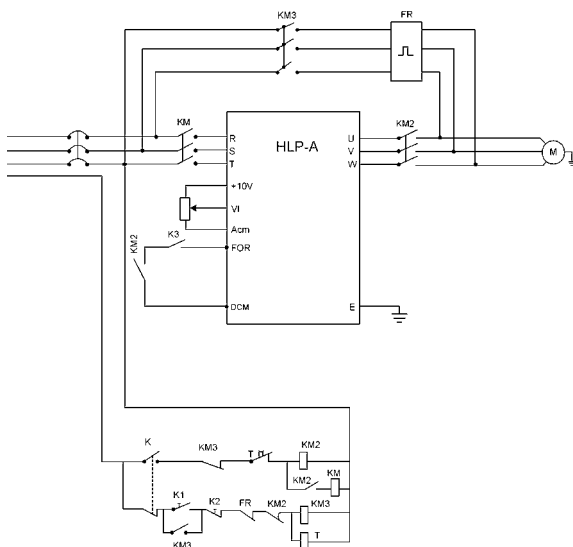

Note:

- ① K is a switch for power frequency/variable frequency.
- ② K_1 is a start button and K_2 is a stop button for power frequency.
- ③ The stopping mode is set for coasting stop.
- ④ K_3 is a start and stop button in variable frequency state.

7. Example application of simple water supply with constant pressure

(1) Use a pressure transmitter with measuring range of 0-10kg, feedback of 4-20mA, requiring water supply at the pressure of 5kg with alarming at the upper limit of 6kg and the lower limit of 4kg. The start from the panel stops.

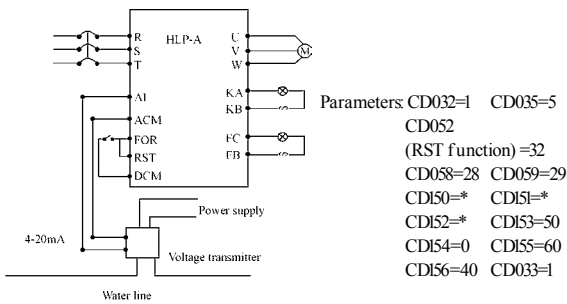

* Note: CD150, CD151 and CD152 should be set according to the actual conditions. For general water supply with constant pressure, CD150=80~100, CD151=2.5~3, CD152=0.

(2) For a resistance transmission pressure gauge of 0~10kg it is required to control operation and stop by external terminals and give a target value through a potentiometer.

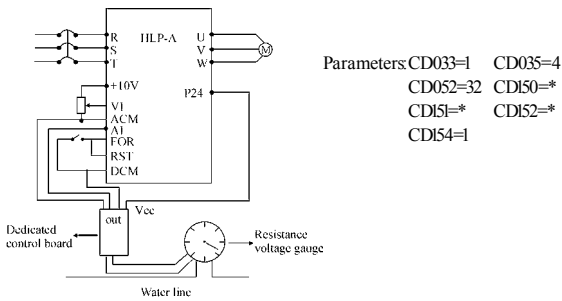

Attention:

① The target value of HLP-A can be selected in two ways, one is to set it on the panel and another is the analog of 0~10V.

- ② The feedback signal is 4-20mA. Others are invalid.
- ③ In this example the target value is given by the potentiometer (0-10V).
- ④ CD150, CD151 and CD152 should be set according to the actual condition. (Refer to the parameter description.)
- ⑤ The special panel for PID is designed according to general resistance transmission pressure gauge with input internal resistance converting to the standard signal in 0-400Ω. When the resistance value of the resistance transmission pressure gauge used by the customer exceeds the specified range please change the resistance transmission pressure gauge or connect a resistor in parallel for correction.
- ⑥ Output resistance values vary with different manufacturers of resistance transmission pressure gauge. After conversion the levels of current signal are different. The user can set a target value consistent with its actual conditions by themselves.

8. Example common application of analog and multi-speed:

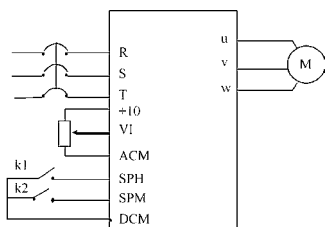
Requirement: Speed 1 is given frequency by analog. Use a switch to switch it and turn to external control multi-speed run.



Parameters:

CD034=1	CD076=2
CD053=20	CD054=21
CD080=15	CD081=30
CD082=25	

Action Description:

①

K1 State	K2 State	Operating Frequency
OFF	OFF	Given by a potentiometer
ON	OFF	Speed 2 (15Hz)
OFF	ON	Speed 3 (30Hz)
ON	ON	Speed 4 (25Hz)

② The switching of forward and reverse rotation can be implemented through either multi-function terminals or the FOR/REV key on the panel. (In this

example the switching is made through the panel)

9. Example application of Auto PLC Suspend

Requirement: Auto PLC can be suspended during the internal control multi-speed run. After handling the related problems it can resume.

(1) Connection

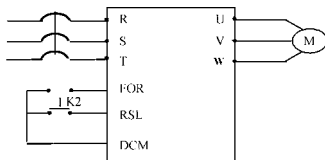

(2) Parameter CD033=1, FOR terminal controls operation

CD055=31 SPL terminal is set for Auto PLC reset suspend function.

CD095=1 Auto PLC Memory CD077=1 Cycling run

CD076=4 Internal control multi-speed

CD080=15 CD084=20 CD082=25 CD000=10

CD087=10 CD088=10 CD089=10 CD090=10

(3) Operating curve

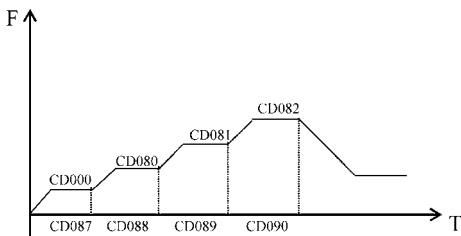

(4) Operation description

① (K1) FOR is closed and the inverter will run according to the program set by internal control multi-speeds.

② When it is required to stop due to fault and process or other reasons, K1 will be opened. And the inverter will stop output and suspend counting time. After the fault is removed K1 will be closed and the inverter will continue to run according to original program.

③ When it is required to run again from the beginning due to fault and process stop K1 should be opened. Press K2 to reset. By closing K1 it will restart to run.

Appendix 2: Appearance and Installation Dimensions

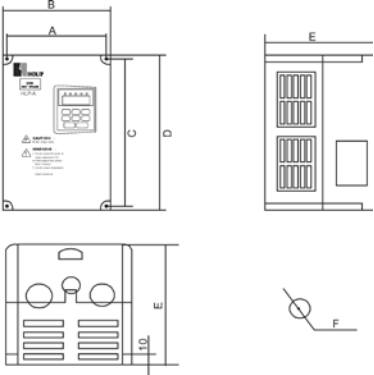
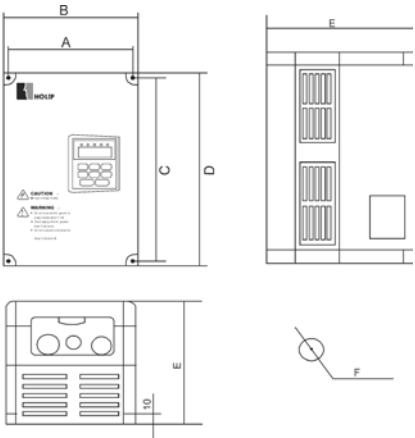
Inverter Model	Appearance and Installation Dimensions
HLP A00D423C HLP A0D7523C HLP A01D523C HLP A0D7543C HLP A01D543C HLP A02D243C	 <p style="text-align: right;">Unit: mm</p>
HLP A02D223B HLP A03D723B HLP A03D743B	 <p style="text-align: right;">Unit: mm</p>

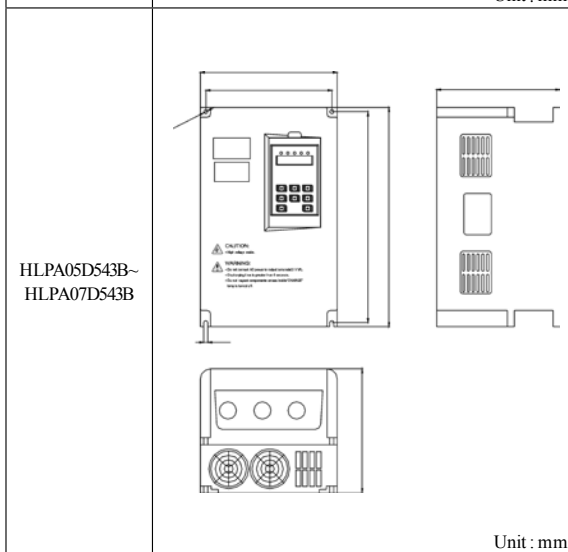
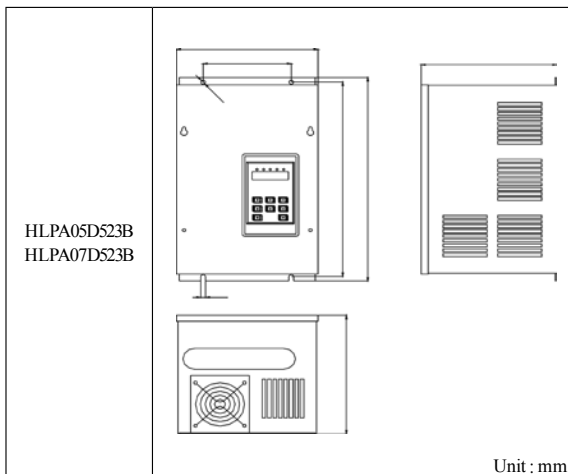

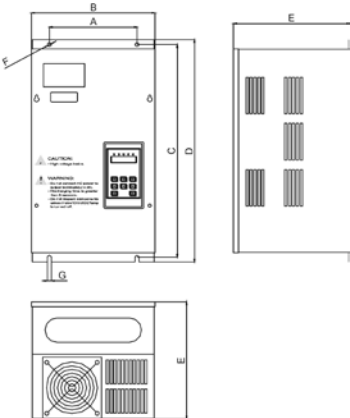
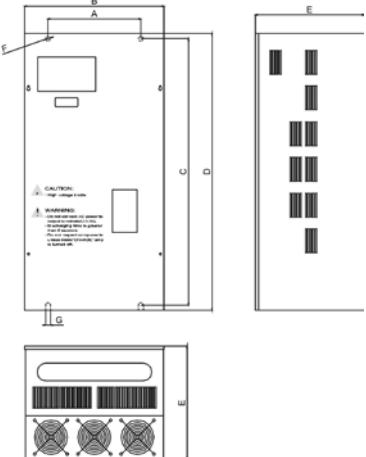
<p>HLP A001123B ~ HLP A005523B HLP A001143B ~ HLP A005543B</p>	 <p style="text-align: right;">Unit : mm</p>
<p>HLP A007523B ~ HLP A009023B HLP A007543B ~ HLP A016043B</p>	 <p style="text-align: right;">Unit : mm</p>

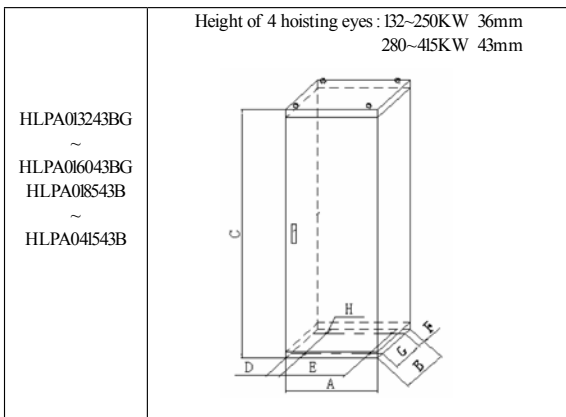

2. External Dimensions Table (Unit: mm)

Inverter Model	A	B	C	D	E	F	G	H
HLPA00D423C	116	125	161	170	141	Φ5		
HLPA0D7523C								
HLPA01D523C								
HLPA0D7543C								
HLPA01D543C								
HLPA02D243C								
HLPA02D223B	128	140	238	250	157	Φ5		
HLPA03D723B								
HLPA03D743B								
HLPA05D523B	130	208	325	340	199	Φ7		
HLPA07D523B								
HLPA05D543B	184	200	306	318	180	Φ6	6	
HLPA07D543B								
HLPA001123B	182	257	437	457	242	Φ8	8	
HLPA001143B								
HLPA001543B								
HLPA001523B								
HLPA18D523B	206	281	490	510	242	Φ8	8	
HLPA18D543B								
HLPA002243B								
HLPA002223B								

Inverter Model	A	B	C	D	E	F	G	H
HLP A003043B	239	315	490	510	242	Φ8	8	
HLP A003023B HLP A003743B HLP A004543B HLP A005543B	250	345	650	670	325	Φ10	10	
HLP A003723B HLP A007543B	300	450	768	800	350	Φ16	16	
HLP A004523B HLP A009043B	300	450	828	860	350	Φ16	16	
HLP A005523B HLP A007523B HLP A009023B HLP A011043B HLP A013243B	500	650	868	900	400	Φ16	16	
HLP A016043B	560	650	868	900	400	Φ16	16	
HLP A013243BG HLP A016043BG	600	600	1649	90	420	90	400	Φ16
HLP A018543B ~ HLP A025043B	600	600	1805	90	420	90	400	Φ16
HLP A028043B ~ HLP A031543B	685	600	2225	90	505	90	400	Φ16
HLP A034543B ~ HLP A041543B	855	600	2279	90	675	90	400	Φ16

Appendix 3: Appearance and Installation Dimensions

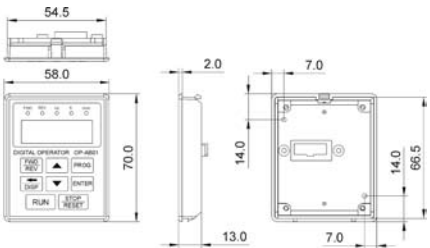
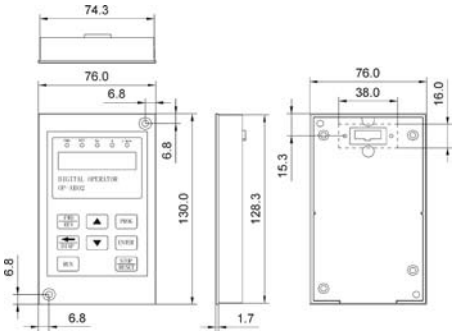
Type	Appearance and Installation Dimensions
<p>OP-AB01 OP-AC01</p>	 <p>Technical drawing showing the appearance and installation dimensions for OP-AB01 and OP-AC01. The drawing includes three views: a top view, a side view, and a back view. The top view shows a width of 54.5 mm and a total width of 58.0 mm. The side view shows a height of 70.0 mm and a depth of 2.0 mm. The back view shows a total width of 7.0 mm, a height of 66.5 mm, and a depth of 13.0 mm. The front view shows a digital display and several control buttons labeled: STOP REV, PROG, STOP, ENTER, RUN, and STOP/RESET.</p> <p style="text-align: right;">Unit : mm</p>
<p>OP-AB02</p>	 <p>Technical drawing showing the appearance and installation dimensions for OP-AB02. The drawing includes three views: a top view, a side view, and a back view. The top view shows a width of 74.3 mm and a total width of 76.0 mm. The side view shows a height of 130.0 mm and a depth of 1.7 mm. The back view shows a total width of 76.0 mm, a height of 16.0 mm, and a depth of 15.3 mm. The front view shows a digital display and several control buttons labeled: STOP REV, PROG, STOP, ENTER, RUN, and STOP/RESET.</p> <p style="text-align: right;">Unit : mm</p>

Appendix 4: Description of Parameter Setting for HLP-A Inverter

1. Requirements:

Use a potentiometer to control the speed and a button to control starting or stopping of the inverter.

2. Setting requirements:

1) Wiring

(1) 220V power supply, connecting to any two terminals of R, S, T, 3φ220 connecting to R, S, T terminals; 3φ380 connecting to R, S, T terminals, paying attention to the machine model. Do not mistake the inverter s of 380V class and 220V class.

Special attention:

Connecting of the inverter of 220V class to 380 V class power will cause blowup of the inverter. The earth wire need to be connected separately to earth and must not be connected to zero line.

(2) U、V、W should be connected to the motor and the earth wire must be correctly (separately) connected to earth.

(3) The three ends of potentiometer are respectively connected to +10V, VI, ACM. Adjust the speed. VI terminal is connected to the center tap of potentiometer.

(4) External switches are connected to the terminals of FOR, DCM (Control operation).

2) Wiring Diagram

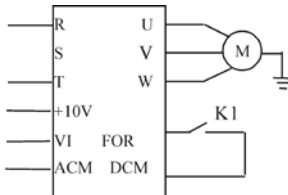

Single phase 220V inverter as example

3) Parameter Setting

(1) Turn on the power to display the version number, later 000.00 ;

(2) Press Key “PROG” (Program) to enter to enter to programming status showing CD000;

(3) Modify the parameter of CD033 to set the operation mode for the operation with external terminal. Press Δ to reach CD033 or use ←, Δ to make the display reach CD033 (Note: Key ← is for shifting), and then press Key “SET”

for confirmation. When 0 (i.e. content of CD033) is displayed, press Δ to change the value to "1" and press Key "SET" for confirmation. It will display END and later CD034. Other parameters can be set in the same way. After finishing setting, find PROG Key and return to the main menu to show the value for frequency.

(4) Other parameters setting:

CD033 : 1 < External terminal control >

CD034 : 1 < External potentiometer control >

CD050 : 1 < FOR terminal is set to RUN, Close RUN, Open STOP >

Finally CD010=1, < Parameter Lock, i.e. lock the parameters. When it needs to be reset, first set CD010 to 0, i.e. unlock >

(5) Run operation

- ① When the external switch K1 is closed it runs;
- ② Adjust the knob of potentiometer for tuning the speed;
- ③ When the job is finished adjust the knob of potentiometer to zero;
- ④ Press K1 < Open >, the inverter stops;
- ⑤ Power off.

(6) Attentions:

- ① Both the power line and motor line must be correctly connected.
- ② During operating the power must be disconnected after the inverter stops.

Appendix 5: User's Records and Feedback

Code	Function	Factory Setting	User's Par.	Code	Function	Factory Setting	User's Par.
CD000	Main Frequency	000		CD087	Timer 1	100	
CD001	Max. Voltage	220/380 acc. to model		CD088	Timer 2	10.0	
CD002	Base Frequency	50.00		CD089	Timer 3	0.0	
CD003	Voltage at Intermediate Frequency	*		CD090	Timer 4	0.0	
CD004	Intermediate Frequency	2.50		CD091	Timer 5	0.0	
CD005	Voltage at Min. Frequency	*		CD092	Timer 6	0.0	
CD006	Min. Frequency	0.50		CD093	Timer 7	0.0	
CD007	Max. Operating Frequency	50.00		CD095	AutoPLC Memory	0	
CD008	Reserved			CD096 ~ CD109	Reserved		
CD009	Frequency Lower Limit	000		CD110	Number of Auxiliary Pump	0	
CD010	Parameter Lock	0		CD111	Continuous Operating Time of Aux. Pump	60	
CD011	Parameter Reset	00		CD112	Interlocking Time of Aux. Pump	50	
CD012	Accel. Time 1	*		CD113	High Speed Running Time	60	
CD013	Decel. Time 1	*		CD114	Low Speed Operating Time	60	
CD014	Accel. Time 2	*		CD115	Stopping Voltage Level	95%	
CD015	Decel. Time 2	*		CD116	Lasting Time of Stopping Voltage Level	30	
CD016	Accel. Time 3	*		CD117	Wakeup Time	80%	
CD017	Decel. Time 3	*		CD118	Sleep Frequency	2000	
CD018	Accel. Time 4	*		CD119	Sleep Frequency Time	20	
CD019	Decel. Time 4	*		CD120	Over-voltage Stall Prevention	1	
CD020 ~ CD029	Reserved			CD121	Stall Prevention Level at ramp-up	150	
CD030	Reserved			CD122	Stall Prevention Level at Constant Speed	0	

Code	Function	Factory Setting	User's Par.	Code	Function	Factory Setting	User's Par.
CD031	Starting Mode	0		CDI23	Stall Prevention Level at Deceleration	0	
CD032	Stopping Mode	0		CDI24	Over-torque Detect Mode	0	
CD033	Source of Run Commands	0		CDI25	Over-torque Detect Level	0	
CD034	Source of Operating Frequency	0		CDI26	Over-torque Detect Time	10	
CD035	Carrier Frequency	*		CDI27	Decel. Time for Stall Prevention at Constant Speed	50	
CD036	Jogging Frequency	5.00		CDI28	Fault Restart Time	10	
CD037	Rev Rotation Select	1		CDI29	Voltage Rise Time during frequency track	0.5	
CD038	STOP Key Select	1		CDI30	Rated Motor Voltage	*	
CD039	S-Curve Time	0.0		CDI31	Rated Motor Current	*	
CD040	Up/down	0.01		CDI32	Motor Pole Number	04	
CD041	Starting Frequency	0.50		CDI33	Rated Motor Revolution	1440	
CD042	Stopping Frequency	0.50		CDI34	Motor No-load Current	40	
CD043	Auto Torque Compensation	2.0		CDI35	Motor Slip Compensation	0	
CD044	Skip Frequency 1	0.00		CDI36 ~ CDI39	Reserved		
CD045	Skip Frequency 2	0.00		CDI40	DC Braking Voltage Level	2.0	
CD046	Skip Frequency 3	0.00		CDI41	DC Braking Time at start	0.0	
CD047	Skip Frequency Range	0.50		CDI42	DC Braking Time at stop	0.0	
CD048	Timer 1 time	0.1		CDI43	Frequency Track Time	50	
CD049	Timer 2 time	1		CDI44	Current Level for Frequency Track	150	
CD050	Multi-input 1 (FOR)	02		CDI45	Restart after Instantaneous Stop	0	
CD051	Multi-input 2 (REV)	03		CDI46	Allowable Power-Breakdown Time	0.5	
CD052	Multi-input 3 (RST)	10		CDI47	Number of Abnormal Restart	0	

Code	Function	Factory Setting	User's Par.	Code	Function	Factory Setting	User's Par.
CD053	Multi-input 4 (SPH)	17		CDI48	Auto Voltage Regulation	1	
CD054	Multi-input 5 (SPM)	18		CDI49	Auto Energy Saving	0	
CD055	Multi-input 6 (SPL)	19		CDI50	Proportional Constant (P)	100%	
CD056	Multi-output 1	01		CDI51	Integral Time (I)	5.0S	
CD057	Multi-output 2	05		CDI52	Differential Time (D)	0	
CD058	Multi-output 3	02		CDI53	Target Value	0	
CD059	Multi-output 4	00		CDI54	PID Target Value	0	
CD060	Multi-output 5	0		CDI55	PID Upper limit	100	
CD061	Uniform Frequency 1	0.00		CDI56	PID Lower Limit	0	
CD062	Uniform Frequency 2	0.00		CDI57 ~ CDI59	Reserved		
CD063	Uniform Frequency Range	0.50		CDI60	Communication Addresses	00	
CD064	Counting value set	00		CDI61	Communication Baud Rate	1	
CD065	Analog Input	0		CDI62	Communication Data Method	0	
CD066	Lower Analog Frequency	0.00		CDI63 ~ CDI66	Reserved		
CD067	Bias Direction at Lower Frequency	0		CDI67	Display Items	0	
CD068	Higher Analog Frequency	50.00		CDI68	Display Items Open	0	
CD069	Bias Direction at Higher Frequency	0		CDI69	Voltage Rating of Inverter	*	
CD070	Analog Negative Bias Reverse	0		CDI70	Rated Current of Inverter	*	
CD071	AM Analog Output Gain	100		CDI71	Software Version	*	
CD072	Up/Down Function	0		CDI72	Fault Record 1	---	
CD073	Up/Down Speed	0		CDI73	Fault Record 2	---	
CD074	Analog Filtering Constant	20		CDI74	Fault Record 3	---	
CD075	Intermediate Counter	0		CDI75	Fault Record 4	---	
CD076	PLC Operation	0		CDI76	Fault Clear	00	
CD077	Auto PLC	0		CDI77	Inverter Model		
CD078	PLC Rotation Direction	0		CDI78	Inverter Frequency Standards	0	
CD079	PLC Ramp Time	0		CDI79	Manufacture Date	*	

Code	Function	Factory Setting	User's Par.	Code	Function	Factory Setting	User's Par.
CD080	Frequency 2	15.00		CD180	Serial No.	*	
CD081	Frequency 3	20.00		CD181 ~ CD250	Reserved		
CD082	Frequency 4	25.00					
CD083	Frequency 5	30.00					
CD084	Frequency 6	35.00					
CD085	Frequency 7	40.00					
CD086	Frequency 8	0.50					



ZHEJIANG HOLIP ELECTRONIC TECHNOLOGY CO., LTD.

TEL: 0571-28891071 FAX: 0571-28891072

<http://www.holip.com>