

FUJI GENERAL-PURPOSE INVERTER FVR-E9S Series

Three-phase 200 V	FVR0.1~3.7E9S-2 FVR0.1~3.7E9S-2JE
Three-phase 400 V	FVR0.4~3.7E9S-4 FVR0.4~3.7E9S-4JE
Single-phase 200 V	FVR0.1~2.2E9S-7 FVR0.1~2.2E9S-7JE



CAUTION

- Make sure you read this instruction manual thoroughly before installing, wiring, operating and inspecting this Inverter.
- Please make sure that this Instruction manual accompanies the Inverter to the end user.
- Keep this instruction manual in order not to lose so that it will always be available for the duration of the Inverter's operating life.
- Product specifications are subject to change for improvement without notice.

Foreword

Thank you for purchasing a Fuji FVR-E9S Series Inverter.

This Inverter is designed for variable-speed operation of three-phase induction motors. Before use, read this instruction manual thoroughly to gain a full understanding of the correct operation procedures.

Incorrect handling of the Inverter may cause problems or may give damages to the Inverter and may reduce the Inverter's operating life.

This instruction manual does not contain instructions regarding optional components such as interface cards. For details on such optional components, please refer to the separate instruction manuals for each component.

Please keep this instruction manual carefully and accompany to the end user who uses this Inverter.

Contents

1	Introduction	1	11-2	Keypad panel operation modes and displays	24
2	Safety Precautions	1	11-3	Explanation of keypad panel operation	27
3	Inspection Points upon Delivery	5	11-4	Function table	31
4	Product Inquiries and Warranty Information	6	11-5	Description of functions	35
4-1	When making inquiries	6	11-6-1	Description of torque boost	60
4-2	Product warranty	6	11-6-2	Description of torque limit	61
5	Construction and Handling	7	11-6-3	Description of braking torque selection	61
5-1	Construction and part names	7	11-6-4	Description of torque vector control	62
5-2	Handling	8	11-6-5	Description of automatic tuning procedure	63
6	Transportation	9	12	Maintenance and Inspection	64
7	Storage	9	12-1	Daily inspection	64
8	Installation	9	12-2	Periodic inspection	64
8-1	Installation environment	9	12-3	Measuring main circuit power	65
8-2	Installation method	10	12-4	Megger test	65
9	Wiring Procedures	11	12-5	Parts replacement	69
9-1	Main circuit wiring and ground terminal wiring	12	13	Troubleshooting	69
9-2	Control circuit wiring	14	13-1	Protective function	69
9-3	Notes when wiring	16	13-2	Troubleshooting when protective function operates	72
9-4	Basic wiring diagrams	18	13-3	Troubleshooting when motor problem occurs	75
10	Inverter Operation	20	14	Standard specifications	76
10-1	Pre-operation inspection	20	15	External dimensions	80
10-2	Operation method	20	16	Optional equipment	84
10-3	Test operation	21	17	Attention to prevent from failure	86
11	Keypad Panel Operation and Explanation of Functions	22	18	Optional equipment (chinese)	87
11-1	External view	22	19	Attention to prevent from failure (chinese)	88



1. Introduction

This Inverter is designed for variable-speed operation of three-phase induction motors. This instruction manual contains descriptions of the correct procedures for installation, wiring, Inverter operation, keypad panel operation and maintenance and inspection for the Inverter.

2. Safety Precautions

Before carrying out installation, wiring, operation, maintenance or inspection of the Inverter, read this instruction manual thoroughly to gain a full understanding of the correct operation procedures. Make sure that you have read all product details, safety information, warnings and cautions before use.

The following classifications for warnings and cautions are used throughout this manual.

 WARNING	Denotes operating procedures and practices that may result in severe injury or loss of life if not correctly followed.
 CAUTION	Denotes operating procedures and practices that, if not strictly observed, may result in personal injury or damage to the equipment.

The severity of injury or damage that can result from failure to follow a caution given can increase in severity depending on conditions. In any case, the instructions given are very important and should be followed at all times.

APPLICATIONS

 WARNING - FIRE AND PERSONAL INJURY HAZARD
<ul style="list-style-type: none">● This Inverter is designed for variable-speed operation of three-phase induction motors. It cannot be used with single-phase motors or for any other applications, otherwise fire may result.● The Inverter cannot be used by itself for elevators, life-preservation equipment or other equipment which is directly related to human safety. In such situations, sufficient consideration should be given to overall system configuration, not just to the Inverter, otherwise serious accidents could result.

 WARNING - FIRE AND PERSONAL INJURY HAZARD	Reference page
<ul style="list-style-type: none"> ● Install the Inverter to a non-flammable surface such as a metal surface, otherwise fires may result. 	1 0
<ul style="list-style-type: none"> ● Do not place the Inverter near flammable materials, otherwise fires may result. 	1 0
<ul style="list-style-type: none"> ● Do not hold the Inverter by the Inverter cover when transporting it, otherwise the Inverter may fall down, which could cause severe injury. 	9
<ul style="list-style-type: none"> ● Do not let any scraps of thread, paper, sawdust, dirt, metal shavings or other foreign objects get inside the Inverter or onto the cooling fins, otherwise fires or problems with operation may result. 	1 1
<ul style="list-style-type: none"> ● Do not install and operate the Inverter if it is damaged or if some of the parts are missing. Doing so may result in severe personal injury. 	

WIRING

 WARNING - FIRE AND ELECTRIC SHOCK HAZARD	Reference page
<ul style="list-style-type: none"> ● When connecting the Inverter to a power supply, be sure to connect it via a circuit breaker, a leakage current breaker or a fuse, otherwise fires may result. 	1 2
<ul style="list-style-type: none"> ● Use only fuses and circuit breakers with rated capacities that are suitable for use with the Inverter. Failure to do so may result in fire. 	1 2
<ul style="list-style-type: none"> ● Connect the Inverter with a secure ground, otherwise electric shocks or fires may result. 	1 1
<ul style="list-style-type: none"> ● Wiring work should only be carried out by suitably qualified personnel, otherwise electric shocks may result. 	1 1
<ul style="list-style-type: none"> ● Make absolutely sure that the power supply is turned off (open) before wiring, otherwise electric shocks may result. 	1 1
<ul style="list-style-type: none"> ● Wiring work should only be carried out after the Inverter itself has been installed, otherwise electric shocks or injury may result. 	

 CAUTION	Reference page
<ul style="list-style-type: none"> ● Check that the phase and voltage of the AC power supply being connected matches the input phase and rated input voltage of the Inverter. Using an improper power supply may cause injury or damage to equipment. 	1 3
<ul style="list-style-type: none"> ● Do not connect AC power to the output terminals (U, V, W), otherwise injury may result. 	1 3
<ul style="list-style-type: none"> ● The Inverter, motor and wiring produce electromagnetic noise during operation. Make sure that this does not interfere with the operation of any sensors or other equipment which may be nearby, otherwise accidents may result. 	1 7

 WARNING - ELECTRIC SHOCK HAZARD	Reference page
<ul style="list-style-type: none"> ● Always install the Inverter cover before turning on the power supply. In addition, do not remove the Inverter cover while the power is on. Failure to observe these precautions may result in electric shocks. 	2 0
<ul style="list-style-type: none"> ● Do not operate any of the switches with wet hands, otherwise electric shocks may result. 	2 0

 WARNING - ELECTRIC SHOCK AND PERSONAL INJURY HAZARD	Reference page
<ul style="list-style-type: none"> ● If the retry function has been activated and a trip occurs, the Inverter will restart automatically depending on the cause of the trip. Make sure that the system is set up properly so that there will be no danger to personnel when the Inverter starts, otherwise accidents may occur. 	3 9
<ul style="list-style-type: none"> ● If the torque limit function has been selected, the Inverter may start running with differences in the acceleration/deceleration time and speed settings. Make sure that the system is set up properly so that there will be no danger to personnel when the Inverter starts, otherwise accidents may occur. 	4 6
<ul style="list-style-type: none"> ● The STOP key is only effective when keypad panel operation has been selected in the function settings. A separate switch should be installed for emergency stopping purposes. If operation by means of the external signal terminals has been selected, the STOP key on the keypad panel cannot be used to stop Inverter operation. 	1 4, 2 2
<ul style="list-style-type: none"> ● If an alarm reset is carried out while a run signal [FWD/REV] is being input, the Inverter will suddenly restart. Always check that the run signal is not being input before carrying out the alarm reset, otherwise accidents may occur. 	2 2, 3 0
<ul style="list-style-type: none"> ● Never touch the Inverter terminals while the power is fed to the Inverter, regardless of whether the Inverter is running or not. 	

 CAUTION	Reference page
<ul style="list-style-type: none"> ● Do not touch the cooling fins and braking resistor, as they become hot during Inverter operation. 	2 2
<ul style="list-style-type: none"> ● Because it is relatively easy to set the Inverter to high-speed operation, be sure to check the capacity of the motor and the equipment being operated before changing the Inverter function setting. 	3 5, 3 6
<ul style="list-style-type: none"> ● The Inverter braking function cannot be substituted for mechanical means. Attempting to do so may result in injury. 	4 2

 WARNING - ELECTRIC SHOCK HAZARD	Reference page
<ul style="list-style-type: none"> ● Wait at least five minutes after turning off the power before carrying out inspection. Check that the charge indication lamp has gone out. Do not touch the Inverter parts if the lamp is still lit, otherwise electric shocks may result. 	6 4
<ul style="list-style-type: none"> ● Maintenance, inspection and part replacement should only be carried out by suitably qualified personnel. Remove any metallic accessories such as watches and rings before starting work, and use only properly-insulated tools, otherwise electric shocks may result. 	6 4

DISPOSAL

 CAUTION
<ul style="list-style-type: none"> ● Disposal of the Inverter should be entrusted to a suitably-qualified disposal agency, otherwise injury may result.

PACKING

 CAUTION
<ul style="list-style-type: none"> ● Do not stand or sit on the Inverter, otherwise injury may result. ● The number of packing cartons that can be stacked together is printed on the packing container. Do not stack the containers any higher than this, or injury may result.

OTHER

 WARNING - ELECTRIC SHOCK AND PERSONAL INJURY HAZARD	Reference page
<ul style="list-style-type: none"> ● Do not carry out any modifications to the Inverter. Doing so may result in electric shocks and injury. 	6 4

GENERAL CAUTION

All of the illustrations in this instruction manual show the Inverter with the covers and other protective equipment removed in order to facilitate explanation of detailed parts of the Inverter. Be absolutely sure to return all covers and protective equipment to the prescribed positions before operating the Inverter, and make sure that all operations are carried out in accordance with the instructions in this manual.

3. Inspection Points upon Delivery

Please inspect the following points after unpacking your Inverter.

If you have any problems or questions regarding the Inverter, please contact the nearest Fuji sales office or the distributor you purchased the unit from.

- ① Check the nameplate on the Inverter cover to ensure that the specifications correspond to those you ordered.

TYPE	: Inverter type
SOURCE	: Phase, voltage and frequency of input power supply
OUTPUT	: Rated capacity, rated output current, output frequency range
SER.NO.	: Serial No.

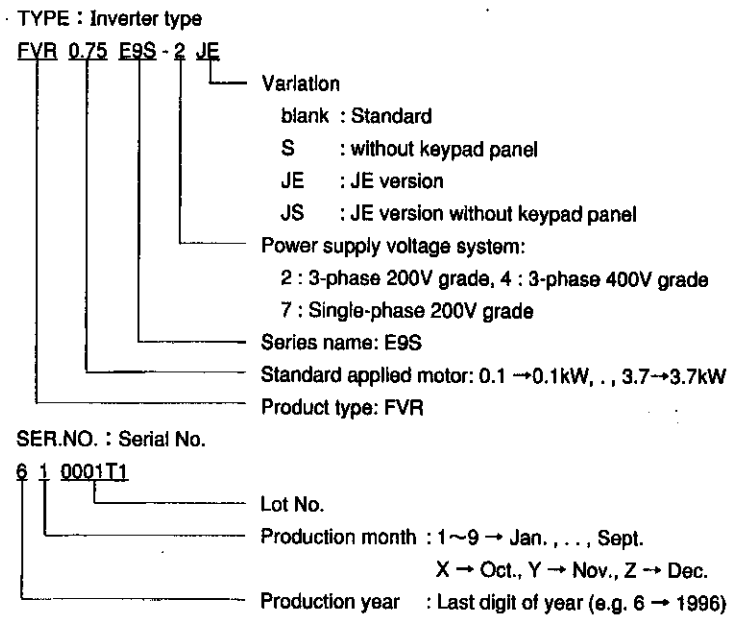
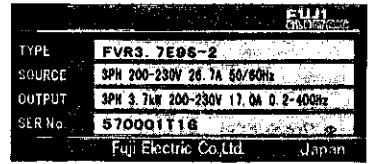

- ② Inspect the unit for any damage, disconnection or bending of the cover or main unit panels which may have occurred during shipping.

4. Product Inquiries and Warranty Information

4-1. When making inquiries

If the Inverter is damaged or if you have any other problems or questions regarding the Inverter, please make a note of the following items and then contact the nearest Fujl sales office or the distributor where the unit was purchased.

- a. Inverter type
- b. Serial No.
- c. Date of purchase
- d. The nature of the problem (for instance, the location and extent of damage, the point which is unclear or the circumstances under which the malfunction occurred)

4-2. Product warranty

This product is guaranteed against defects in workmanship for 12 months from the date of purchase or for 18 months from the date of manufacture indicated on the nameplate, whichever comes first. However, problems caused by the following reasons are not covered by the warranty even if the warranty period has not yet expired.

- ① Problems caused by incorrect operation or by unauthorized repairs or modifications
- ② Problems resulting from using the Inverter under conditions outside the standard specifications
- ③ Damage to the Inverter after purchase or during delivery
- ④ Damage caused by earthquakes, fire, floods, lightning, abnormal voltage fluctuations or other natural disasters and secondary disasters.

5. Construction and Handling

5-1. Construction and part names

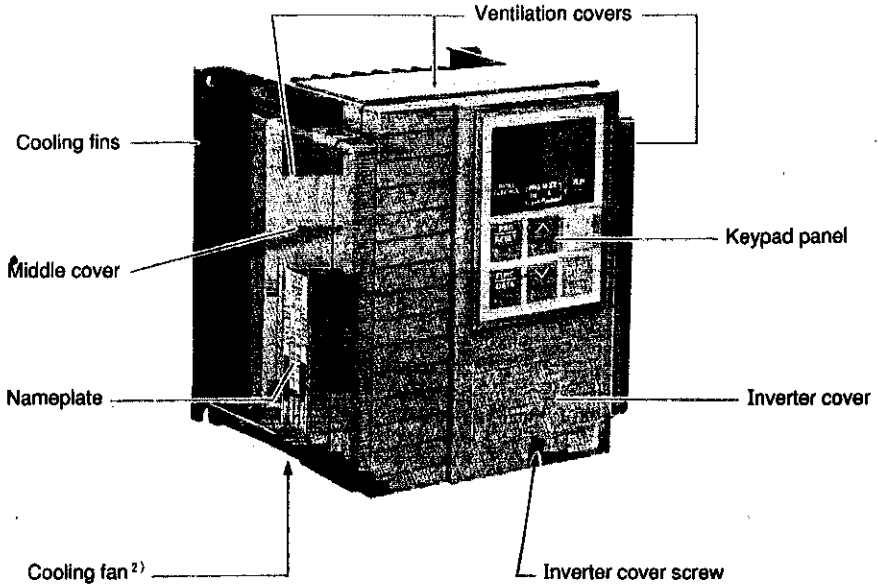

Fig. 5-1-1 Inverter appearance¹⁾

- 1) The appearance and external dimensions of each Inverter model vary according to the input phase, input voltage and output capacity of each model. For details, refer to "15. External dimensions" on page 80.
- 2) No cooling fan is attached to the Inverter model with an output rating of less than 0.75kW.

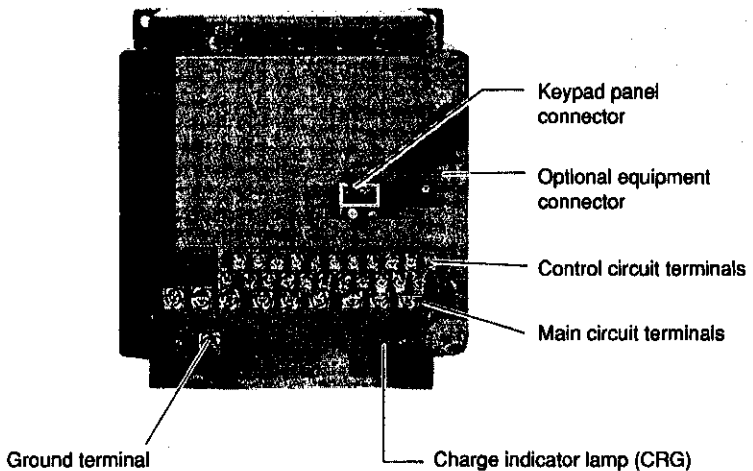

Fig. 5-1-2 Internal Inverter parts (shown with Inverter cover removed)

5-2. Handling

(1) Removing the Inverter cover

Loosen the Inverter cover screw (refer to Fig. 5-1-1), and then remove the cover as shown in Fig. 5-2-1. The Inverter cover can be removed with the keypad panel still attached.

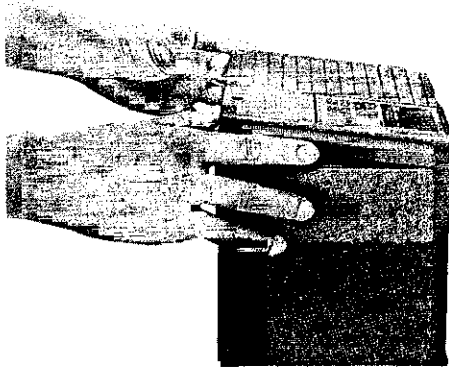

Fig. 5-2-1 Removing the Inverter cover

(2) Removing the keypad panel

After removing the Inverter cover as described in (1) above, loosen the two keypad panel fixing screws on the reverse side of the cover (refer to Fig. 5-2-2), and then remove the keypad panel.

If the optional connection cable (sold separately) is used, remote control operation is possible. (Refer to Fig. 5-2-3.)

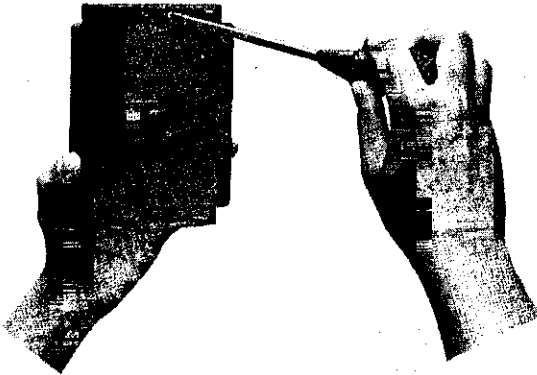
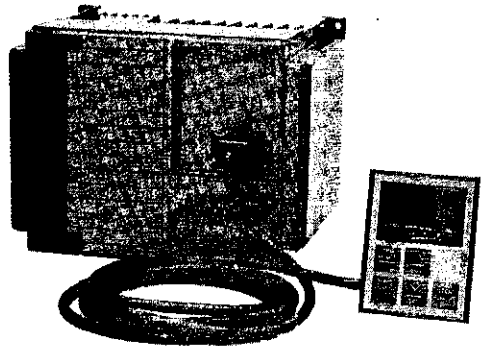

Fig. 5-2-2 Removing the keypad panel

Fig. 5-2-3



6. Transportation

Be sure to hold the main unit when carrying the Inverter.

If you hold the cover or other parts, the Inverter may become damaged or fall down.

Because the Inverter cover is made from plastic, be careful not to apply too much force to it during transportation.

7. Storage

Store under the conditions listed in Table 7-1-1.

Table 7-1-1 Storage conditions

Item	Conditions	
Ambient temperature	-10 ~ 50 °C	Avoid places where sudden changes in temperature occur which could cause freezing or condensation.
Storing temperature ¹⁾	-20 ~ 65 °C	
Relative humidity	20 ~ 95 % ²⁾	
Environment	The place should be away from direct sunlight and free from dust, corrosive gases, inflammable gases, oil mists, steam, dripping water or vibration. Salty environments should preferably be avoided.	

¹⁾ : The storing temperature means short-term temperature conditions for transportation.

²⁾ : Condensation or freezing may occur in places where large variations in temperature occur, even if the relative humidity is within the specified range in Table 7-1-1.

Such places should be avoided.

- ① Do not place the Inverter directly onto the floor. It should always be placed on top of a stand or shelf.
- ② If the Inverter is being stored in an environment which does not satisfy the conditions in Table 7-1-1, cover it with a plastic sheet to protect it.
- ③ If you are worried about humidity affecting the Inverter, place some desiccating agent (such as silica gel) with the Inverter, and then cover it as explained in ② above.

8. Installation

8-1. Installation environment

Install the Inverter in a location that meets the following requirements:

Table 8-1-1 Installation environment

Item	Condition
Place	Indoors
Ambient temperature	-10 ~ +50 °C (Remove the ventilation covers when the temperature exceeds +40°C)
Relative humidity	20 ~ 95 %
Environment	Avoid any location subject to dust, direct sunlight, corrosive gas, inflammable gas, oil mist, steam or dripping water. Salty environments should preferably be avoided. Avoid places where condensation may occur in places where large variations in temperature occur.
Altitude	1000 meters or less
Vibration	5.9 m/s ² {0.6G} or less

8-2. Installation method

- ① Place the Inverter vertically so that the "FVR-E9S" letters can be seen at the front, and then bolt it firmly to a steady structure.

Do not install the Inverter upside down or horizontally.

- ② The Inverter will generate heat during operation. Allow sufficient space around the unit as shown in Fig. 8-2-1 to ensure adequate ventilation.

Because the air heated by the Inverter is let out upwards by the built-in cooling fans, do not place the Inverter underneath low heat resistance material.

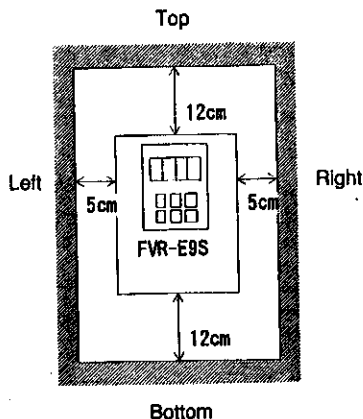



Fig. 8-2-1 Installation direction and mounting space

- ③ The cooling fin temperature will reach around 90°C during operation. Please use non-flammable material for the Inverter mounting plate.

	WARNING Install the Inverter to a non-flammable surface such as a metal surface, otherwise fires may result.
---	---

- ④ If placing the Inverter in an Inverter panel, be sure to allow adequate ventilation to prevent the ambient temperature for the Inverter from exceeding the range given in Table 8-1-1. Do not place the Inverter into small enclosed areas which do not allow proper ventilation.
- ⑤ When two or more Inverters are installed in an Inverter panel, locate them side by side in order to avoid the influence of heat generated by other Inverters. If the Inverters must be installed in a vertical row, provide a partition plate between them to prevent the heat from the lower Inverter from affecting the upper Inverter.

- ⑥ If the ambient temperature around the Inverter becomes greater than 40°C, remove the ventilation covers at the top and at both sides of the Inverter.

The Inverter should not be used under ambient temperatures which exceed 50°C, even if the covers are removed.



CAUTION

Do not let any scraps of thread, paper, sawdust, dirt, metal shavings or other foreign objects get inside the Inverter or onto the cooling fins, otherwise fires or problems with operation may result.

9. Wiring Procedures

Remove the Inverter cover to expose the terminal board. Pay attention to the following points during wiring to avoid making incorrect connections.

- ① Always connect the power supply to the main power supply terminals R, S and T (S is not provided for single-phase input models). Connecting the power supply to any other terminals will damage the Inverter.
- ② Be sure to make the Inverter ground terminal being connected with ground in order to prevent accidents such as electric shocks or fire and to reduce electromagnetic noise.
- ③ Use crimp terminals for wiring to ensure high reliability.
- ④ Once the wiring has been completed, check the following.
 - a. Have all wires been connected correctly?
 - b. Have any connections been omitted?
 - c. Are there any short circuit(s) between terminals and wires or to ground?
- ⑤ If changing the wiring after the power has been turned on, note that it takes some time for the smoothing capacitor in the DC section of the main circuit to be fully discharged. To avoid danger, wait for 5 minutes or more after the power supply has been turned off before removing the Inverter cover, and check that the charge lamp has been extinguished before doing any work.



WARNING

- Wait at least five minutes after turning off the power before carrying out inspection. Check that the charge indication lamp has gone out. Do not touch the Inverter parts if the lamp is still lit, otherwise electric shocks may result.
- Wiring work should only be carried out by suitably qualified personnel, otherwise electric shocks may result.
- Connect the Inverter with a secure ground, otherwise electric shocks or fires may result.

9-1. Main circuit wiring and ground terminal wiring

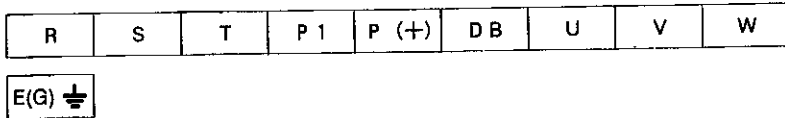

Fig.9-1-1 Main circuit terminal layout (for 3-phase 200V/400V input)

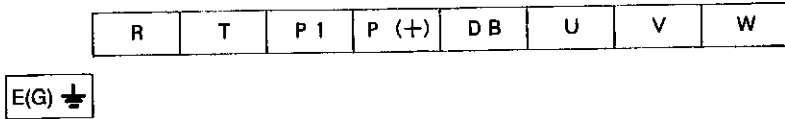

Fig.9-1-2 Main circuit terminal layout (for single-phase 200V input)

Table 9-1-1 Explanation of main circuit terminal and ground terminal functions

Terminal Symbol	Terminal Name	Explanation
R, S, T *	Main circuit power terminals	Connect the power supply.
U, V, W	Inverter output terminals	Connect a three-phase induction motor.
P 1, P (+)	DC reactor connection terminals	Connect a power factor correcting DC reactor (option)
P (+), DB	External braking resistor terminals	Connect an external braking resistor (option) Note : 200W or lower models have no DB terminal.
E (G) ↓	Inverter ground terminal	Ground terminal for Inverter chassis

* : "S" terminal is not provided for single phase input models

(1) Main power supply terminals [R, S, T]

- ① Connect the power supply to the main power supply terminals R, S and T (in case of single-phase input type, R and T) via a circuit breaker, leakage current breaker or fuse. There is no need to match the phase when connecting. (Refer to page 85.)
- ② It is recommended that the main power supply is fed to the Inverter through a magnet contactor to prevent further problems or damage to the Inverter in the event of a failure. (Refer to page 85.)



WARNING

- When connecting the Inverter to a power supply, be sure to connect it via a circuit breaker, a leakage current breaker or a fuse, otherwise fires may result.
- Use only fuses and circuit breakers with rated capacities that are suitable for use with the Inverter. Failure to do so may result in fire.

(2) Inverter output terminals [U, V, W]

- ① Connect a 3-phase motor to the Inverter output terminals U, V and W in correct order.
If the direction of operation is reversed, interchange any two of the U, V or W connections.
- ② Do not connect a power factor improving capacitor or a surge absorber to the output side of the Inverter.

(3) DC reactor terminals [P1, P(+)]

- ① These terminals are used to connect an optional power factor improving DC reactor.
- ② These terminals are connected by a short-circuiting conductor at the time of shipment from the factory, so remove this conductor before connecting the DC reactor.
- ③ Make sure that the short-circuiting conductor between terminals P1 and P(+) is fastened when a DC reactor is not being used.
- ④ Use wires with a length of 2 meters or less to connect the DC reactor.

(4) External braking resistor terminals [P(+), DB]

- ① These terminals are used to connect an optional external braking resistor.
- ② Use two twisted wires with a length of less than 5 meters to connect the external braking resistor.
- ③ Never short-circuit the P(+) and DB terminals, otherwise damage to the Inverter will occur.

(5) Ground terminal [E(G) ⚡]

The ground terminal should always be connected to the ground for safety reasons and to reduce electromagnetic noise.

- ① The grounding wire should be as thick and as short as possible, and it should be connected to a ground terminal which is provided for use with Inverter systems.
- ② It is the responsibility of the user or the person installing the Inverter to provide proper grounding according to National Electric Code and local codes.



CAUTION

- Check that the phase and voltage of the AC power supply being connected matches the input phase and rated input voltage of the Inverter. Using an improper power supply may cause injury or damage to equipment.
- Do not connect AC power to the output terminals (U, V, W), otherwise injury may result.

9-2. Control circuit wiring

30A	30B	Y1	FMA	PLC	BX	RST	C1	13	12	11
30C	FMP	X1	X2	X3	X4	REV	FWD	THR	CM	

Fig.9-2-1 Control circuit terminal layout

Descriptions of the functions of each control circuit terminal are given in Table 9-2-1.

The connection methods for the control circuit terminals differ according to the function settings. Connect according to the functions being used.

- (1) Control input terminals [FWD, REV, BX, THR, RST, X1, X2, X3, X4]

The equivalent circuit diagram is shown in Fig. 9-2-2.

If you use a contactor for input, use a contactor with high reliability which does not have any closing defects.

- (2) RUN command terminals [FWD, REV]

The RUN command terminals FWD and CM are shorted with a shorting bar at the time of shipment. In this condition, the Inverter starts when the RUN key on the keypad panel is pressed, and it stops when the STOP key is pressed.

- (3) Trip command terminal (External fault) [THR]

The THR and CM terminals are shorted with a shorting bar at the time of shipment.

To use the THR terminal, remove the shorting bar and connect a relay which turns off when there is an abnormality in the external unit.

If a switch which can be turned off by pressing a button is connected, it can be used as an emergency stop switch.

- (4) Open collector output terminal [Y1]

The equivalent circuit diagram is shown in Fig. 9-2-3.

When connecting a control relay, connect surge absorption diodes in parallel to the solenoid coil.

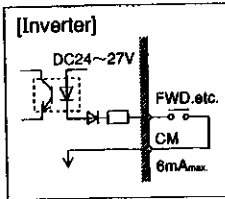

Fig.9-2-2

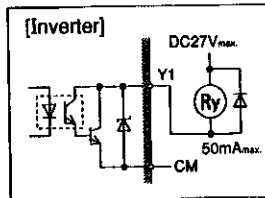

Fig.9-2-3

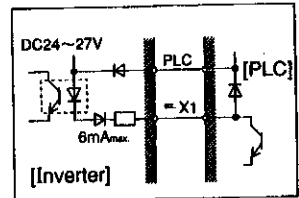

Fig.9-2-4



WARNING

The STOP key is only effective when keypad panel operation has been selected in the function settings. A separate switch should be installed for emergency stopping purposes.

Table 9-2-1 Description of control circuit terminal

Classification	Symbol	Terminal name	Description
Frequency setting	1 3	Potentiometer power supply	+10V DC power supply for frequency setting potentiometer (maximum output current : 10mA)
	1 2	Voltage input	0 to +10V DC / 0 to (maximum output frequency)
	1 1 ¹⁾	Common terminal	Common terminal for terminals 12, 13, C1 and FMA.
	C 1	Current input	DC 4 to 20mA/0 to 100% (input resistance 250 Ω)
Control input	F W D	Forward operation command	FWD-CM CLOSE : The motor runs in the forward direction. ²⁾ OPEN : The motor decelerates and stops.
	R E V	Reverse operation command	REV-CM CLOSE : The motor runs in the reverse direction. ²⁾ OPEN : The motor decelerates and stops.
	B X	Coast-to-stop command	Inverter output will be stopped and the motor will coast to a stop when BX-CM is closed. No alarm signal will be output.
	T H R	Trip command (External fault)	• When THR-CM is open while the Inverter is running, the Inverter output will be stopped (the motor will coast to a stop) and an alarm signal will be output. This alarm signal is held internally until reset command is issued. • Functions as an edit permit command by means of function change.
	R S T	Alarm reset	The hold condition after an Inverter trip is reset when RST-CM is closed.
	X1,X2,X3	Multistep freq. select	Terminals 1 - 3 function as multistep frequency terminals.
	X 4	Function extension	Functions as indicated below depending on the function setting. 1) RT1 : Acceleration/deceleration time 2 selection 2) X4 : Multistep frequency selection terminal 4 3) VF2 : V/F 2 selection 4) HLD : Hold signal for 3-wire operation
	P L C	PLC terminal	Connect the power supply terminal from a PLC.
	C M ¹⁾	Common terminal	Common terminal for control input signal and FMP.
Monitor output	F M A	Analog monitor	• Outputs one of the following signals in terms of DC voltage signal depending on function setting. 1) Output frequency , 2) Output current 3) Output torque , 4) Load factor • Up to 2 meters rated at DC 10V·1mA can be connected.
	F M P	Frequency monitor (Pulse output)	Outputs the frequency pulse which is proportional to Inverter output frequency. The factor can be set between 10 to 100 (for 6kHz or lower only).
Control output	Y 1	Open collector output	• Outputs one of the following signals depending on function change setting. 1) Inverter running mode (RUN) 2) Frequency level detection (FDT) 3) Frequency equivalence signal (FAR) 4) Undervoltage stop mode (LV) 5) Torque limiting mode (TL) 6) Auto-restart mode after momentary power loss (IP) • Allowable load : Max. DC 27V, max. DC 50mA
	30A,30B 30C	Alarm output (any fault)	Outputs a contact signal(1c) when a protective function is activated. (Contact rating: AC 250V, 0.3A, cos φ =0.3)

¹⁾ : Terminals "11" and "CM" have the same potential.

²⁾ : During both FWD and REV are ON, the motor decelerates and stops.

9-3. Notes when wiring

Take note of the following points when carrying out wiring.

(1) Connecting the surge absorbers

The sudden changes in current which are caused by the solenoid coils in magnet contactors and relays in the control circuit and other Inverter circuits may cause surge voltages (noise), and such surge voltages can cause malfunction of the control circuit and other Inverter circuits. In such cases, connect surge absorbers in parallel to the solenoid coil which is producing the surge voltage as shown in Fig. 9-3-1.

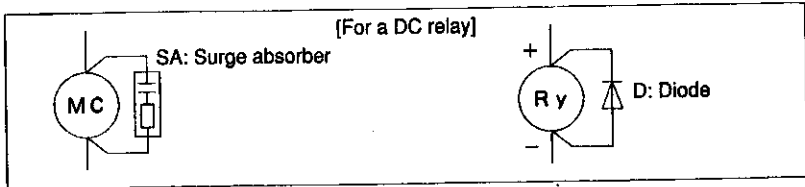

Fig. 9-3-1 Surge protector connection diagram

(2) Control circuit wiring

- ① The wires which are connected to the control circuit terminals should be shielded wires of a 0.75 mm² or more cross-section.
- ② The control circuit wiring should be kept as far away as possible from the main circuit and external sequence circuit wiring. If the control circuit wiring must cross the main circuit or other wiring, it should be so arranged that the wires cross at a right angle.
- ③ If long wires are being used, they should be shielded wires.
- ④ The control circuit wires shall be routed so that they do not touch the main circuit terminal blocks directly.

(3) Shield covering connection

One end of the shield of shielded wires should be connected to a common terminal as shown in Fig.9-3-2. Do not connect it to the ground terminal E(G) ⚡ or to any other ground. The other end should be left open.

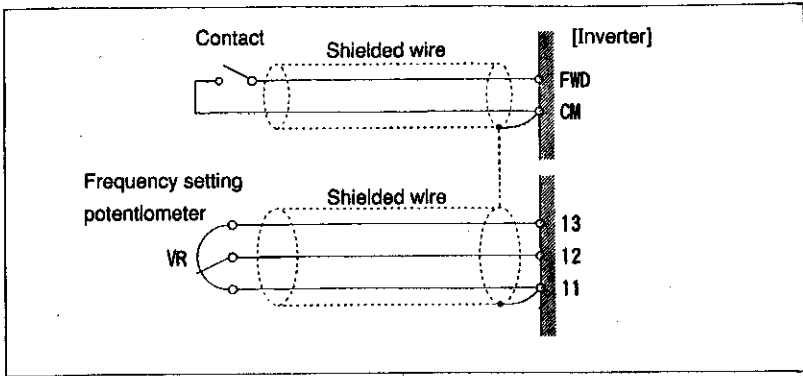

Fig.9-3-2 Connection of the shielded wire covering



CAUTION

● The Inverter, motor and wiring produce electromagnetic noise during operation. Make sure that this does not interfere with the operation of any sensors or other equipment which may be nearby, otherwise accidents may result.

9-4. Basic Wiring Diagrams

1) Keypad Panel Operation

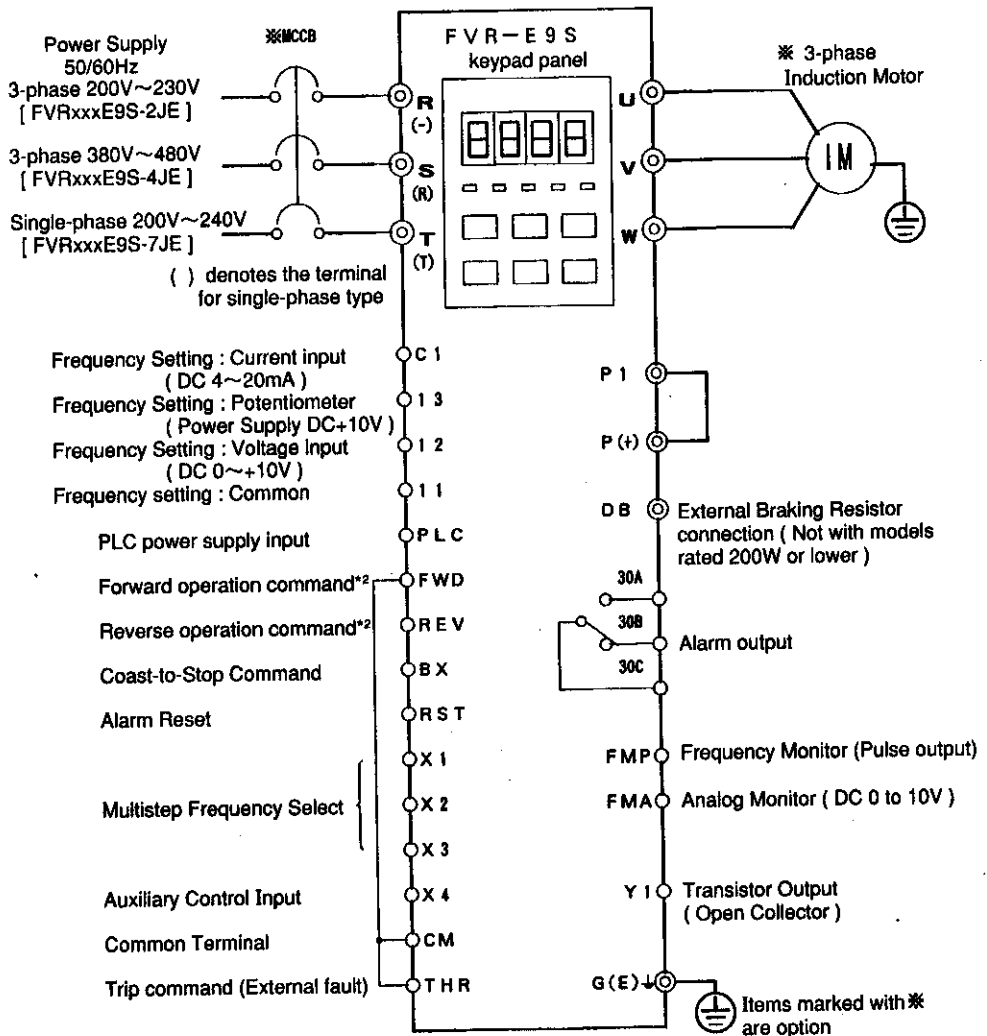

Fig.9-4-1 Basic Circuit Diagram for Keypad Panel Operation

- *1 When the Inverter is shipped from the factory, you can change the frequency setting by pressing the \wedge and \vee keys and operate and stop the Inverter by pressing the **RUN** and **STOP** keys, simply by connecting a power supply and a motor.
- *2 The Inverter runs in the forward direction when FWD = ON and REV = OFF, and runs in reverse when FWD = OFF and REV = ON. If both FWD and REV are ON or OFF simultaneously, the Inverter will not run.
- *3 If connecting a power supply with a capacity that exceeds 500kVA, connect the optional matching reactor (ACR) to the power supply side of the Inverter.
- *4 Connect any magnet switches and solenoids which are near the Inverter to a surge absorber in parallel.

2) External Operation

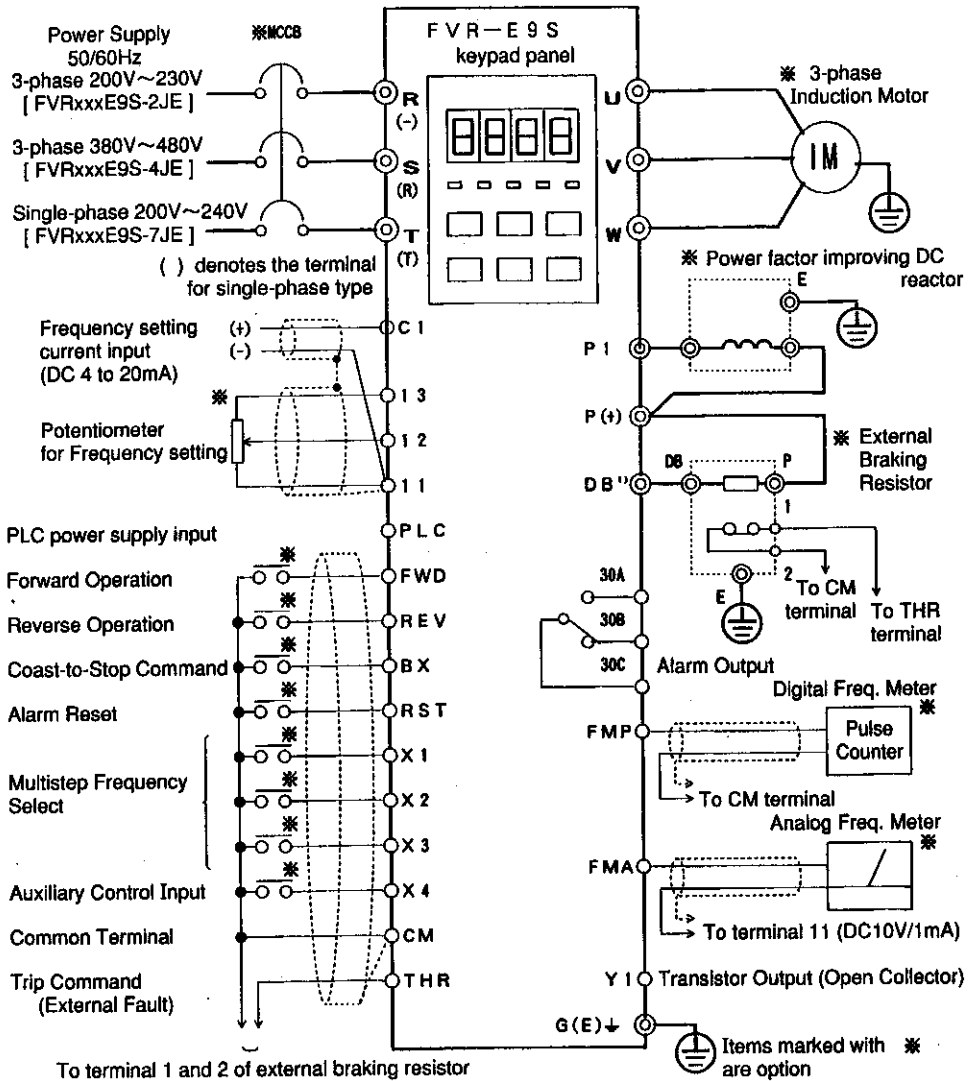

Fig.9-4-2 Basic Circuit Diagram for External Operation

1) "DB" terminal is provided for 400W or more models only

- *1 Frequency setting and Inverter operation can be carried out externally by using the analog frequency meter and contact signals. For function settings, set F01:1 and F02:1.
- *2 If connecting a power supply with a capacity that exceeds 500kVA, connect the optional matching reactor (ACR) to the power supply side of the Inverter.
- *3 Connect any magnet switches and solenoids which are near the Inverter to a surge absorber in parallel.
- *4 If connecting a power factor improving DC reactor, remove the shorting bar from the P1 and P(+) terminals.
- *5 The wires which are connected to the control circuit terminals should be shielded wires.

10. Inverter Operation

10-1. Pre-operation inspection

Check the following items before supplying power to the Inverter.

① Check the wiring for errors.

In particular, check that Inverter terminals U, V and W are not connected to the power supply, and also check that the ground terminal E(G) \oplus is connected to a secure ground.

② Make sure that there are no short circuits or accidental ground connections between the terminals or between uncovered charging sections.

③ Make sure that all screw and terminal connections are tight.

④ Make sure that the motor and the machine are separated.

⑤ Turn all switches off before turning on the power to make sure that the Inverter doesn't start up or operate incorrectly when the power is turned on.

⑥ Check the following after turning on the power supply:

a. Is the charging indicator illuminated?

b. Does the keypad panel appear as shown in Fig. 11-1-2 (with no abnormality being indicated)?

c. Are the Inverter fans operating? (1.5 kW or above)



WARNING

●Always install the Inverter cover before turning on the power supply. In addition, do not remove the Inverter cover while the power is on. Failure to observe these precautions may result in electric shocks.

●Do not operate any of the switches with wet hands, otherwise electric shocks may result.





10-2. Operation method

There are several operation methods which are available.

Select the most appropriate method to suit your application and operating specifications, while referring to "11. Keypad panel operation and explanation" on page 22.

Table 10-2-1 shows the most commonly-used operation methods.

Table 10-2-1 Common operation methods

Operation method	Frequency setting	Operation commands
Operation using the keypad panel	 . 	 . 
Operation using external signal terminals	Potentiometer, analog voltage or analog current	Contact input (switch) FWD-CM terminals REV-CM terminals

* Apart from the combinations given in Table 10-2-1, combinations where frequency settings are made using potentiometer and operation commands are given using the keypad panel are also possible.

10-3. Test operation

If frequency settings and operation commands are given from either the keypad panel or external signal terminals, the motor will operate. Operate according to the instructions in Table 10-3-1.

Test operation should be carried out at a low frequency of not greater than 5 Hz.

The Inverter is set to operation by means of the keypad panel at the time of shipment.

Table 10-3-1 Operation commands

Operation method	Frequency setting	Operation commands
Operation using the keypad panel	(When using the <input type="checkbox"/> and <input type="checkbox"/> keys) When <input type="checkbox"/> is pressed, the frequency setting increases. When <input type="checkbox"/> is pressed, it decreases. If <input type="checkbox"/> pressed while the motor is run the motor accelerates, and if <input type="checkbox"/> is pressed, the motor decelerates. (When using a frequency setting potentiometer)	If <input type="checkbox"/> is pressed, the Inverter starts. If <input type="checkbox"/> is pressed, the Inverter decelerates to a stop.
Operation using external signal terminals	When the potentiometer is turned clockwise, the frequency setting increases, and when it is turned counterclockwise, the frequency setting decreases. If the potentiometer is turned clockwise while the motor is running, the motor accelerates, and if it is turned counterclockwise, the motor decelerates.	When FWD (REV) is on (close), the Inverter starts. When it is off (open), the Inverter decelerates to a stop. Note : The Inverter will not stop by pressing <input type="checkbox"/> key.

Check the following points



- Direction of operation
- Whether operation is smooth (without abnormal noise or vibration)
- Whether acceleration and deceleration are smooth

If there are no problems, Increase the operation speed and check again.

If an abnormality occurs in Inverter or motor operation, stop operation immediately and check the cause of the problem by referring to "13. Troubleshooting (see page 69)".

If voltage is still being applied to the main circuit power supply terminals R, S and T (R, T), you will get an electric shock if you touch Inverter output terminals U, V and W, even if the Inverter output has stopped.

In addition, the smoothing capacitor will still be charged when the power supply is turned off, and it takes some time for it to fully discharge. To avoid any danger, wait at least five minutes after turning off the power supply and make sure that the charge lamp has switched off, and then use a circuit tester to check that the voltage has dropped to a safe level before touching the power supply circuit. If the above test operation does not indicate any abnormality, you can then proceed to normal operation.

 WARNING	<ul style="list-style-type: none"> ●The STOP key is only effective when keypad panel operation has been selected in the function settings. A separate switch should be installed for emergency stopping purposes. ●If an alarm reset is carried out while a run signal is being input, the Inverter will suddenly restart. Always check that the run signal is not being input before carrying out the alarm reset, otherwise accidents may occur.
 CAUTION	<ul style="list-style-type: none"> ●Do not touch the cooling fins and braking resistor, as they become hot during Inverter operation.

11. Keypad Panel Operation and Explanation of Functions

11-1. External view

LED digital monitor

Displays the various function codes and data values during setting of the program. During operation, it displays the set frequency, current, voltage, etc. If a protective STOP occurs, the causes of the problem will be displayed as a code.

RUN mode indicator

Illuminates when keypad panel operation mode has been selected.

PRG/RESET key

This key is used to switch between program mode and other modes. It is also used to reset an abnormal stop condition when the protective function is activated.

FUNC/DATA key

When in normal mode, this key can be used to change the display unit while operation is either stopped or running. When in program mode, this key can be used to read, display and write function codes and setting data.

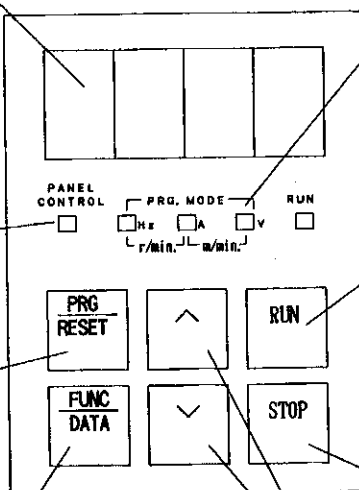

UP/DOWN keys

These keys increase or decrease the frequency or speed. When unit is in program mode, they change the function codes or data values.

Unit display

Unit information is displayed by LEDs. LEDs also light up to indicate that the unit is in program mode.

RUN key

This key is used for starting operation when the keypad panel operation mode is selected. The key does not function in terminal operation mode.

STOP key

This key is used for stopping operation when the keypad panel operation mode is selected. The key does not function in terminal operation mode.

Fig. 11-1-1 Keypad panel

Outline of operation using the keypad panel

When the power supply is activated, the keypad panel display will be as shown in the figure at right.

(The figures "60.00" will be flashing in the display.)

If the **[RUN]** key is pressed at this point, operation will be at 60Hz according to the function code setting made at the factory.

Use the **[STOP]** key to stop operation.

- ※ Check all equipment connections thoroughly before starting operation.

For details, refer to "10. Inverter Operation" on page 20.

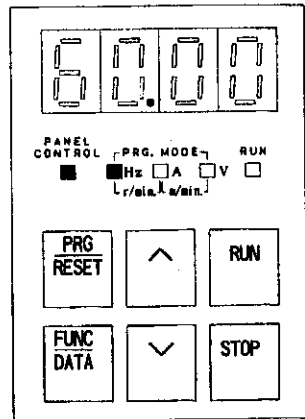

Fig. 11-1-2

11-2. Keypad panel operation modes and displays

(1) Keypad panel operation modes

There are 5 operation modes as shown below. The mode can be changed with the keys on the keypad panel.

- ① Stop mode
- ② RUN mode
- ③ Program mode while stopped
- ④ Program mode while running
- ⑤ TRIP mode

Each mode can be changed as indicated below by means of the keys on the keypad panel or by a trip occurring

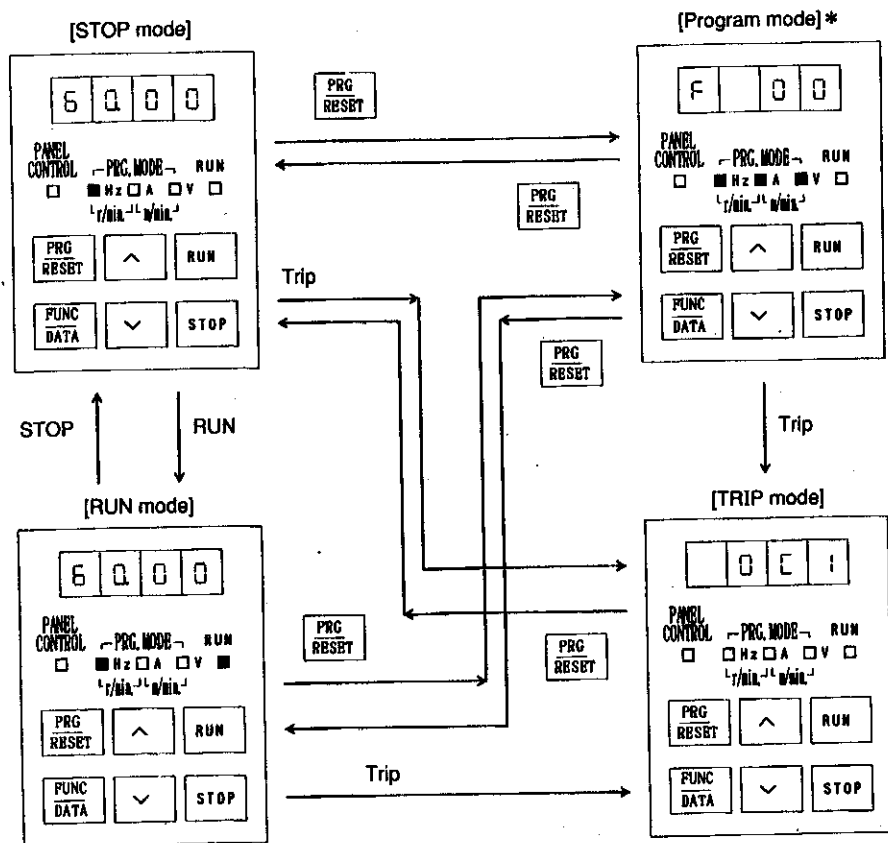

■ : Illuminates or flashes, □ : Off, PANEL CONTROL □ illuminates when in keypad panel mode.

Fig. 11-2-1 Keypad panel operation modes

- * There are two program modes: Program mode while stopped and program mode while running. In program mode while running, some data settings cannot be changed depending on the function code. Refer to "11-5. Description of functions" on page 35 for details. Checking of data can be carried out for all function codes, regardless of whether the Inverter is running or stopped.

(2) Keypad panel displays and key operations

The following tables show the displays and key operations in each keypad panel mode.

(a) Display pattern

Display	Mode	STOP mode	RUN mode	Program mode while stopped	Program mode while running	TRIP mode
 7 seg. L E D		Frequency setting, output current, output voltage, motor speed setting and line speed setting are displayed.	Output frequency, output current, output voltage, motor speed and line speed are displayed.	Function codes and data are displayed.	Function codes and data are displayed.	Cause of trip and trip history are displayed as code.
PRG.MODE <input type="checkbox"/> <input type="checkbox"/> Hz <input type="checkbox"/> A <input type="checkbox"/> V <input type="checkbox"/> r/min. <input type="checkbox"/> r/min.	Frequency setting (Flashes) PRG.MODE <input type="checkbox"/> <input type="checkbox"/> Hz <input type="checkbox"/> A <input type="checkbox"/> V <input type="checkbox"/> r/min. <input type="checkbox"/> r/min.	Output Frequency (Illuminates) PRG.MODE <input type="checkbox"/> <input type="checkbox"/> Hz <input type="checkbox"/> A <input type="checkbox"/> V <input type="checkbox"/> r/min. <input type="checkbox"/> r/min.	Output current (Illuminates) PRG.MODE <input type="checkbox"/> <input type="checkbox"/> Hz <input type="checkbox"/> A <input type="checkbox"/> V <input type="checkbox"/> r/min. <input type="checkbox"/> r/min.	(Flashes) PRG.MODE <input type="checkbox"/> <input type="checkbox"/> Hz <input type="checkbox"/> A <input type="checkbox"/> V <input type="checkbox"/> r/min. <input type="checkbox"/> r/min.	(Illuminated) PRG.MODE <input type="checkbox"/> <input type="checkbox"/> Hz <input type="checkbox"/> A <input type="checkbox"/> V <input type="checkbox"/> r/min. <input type="checkbox"/> r/min.	(Off) PRG.MODE <input type="checkbox"/> <input type="checkbox"/> Hz <input type="checkbox"/> A <input type="checkbox"/> V <input type="checkbox"/> r/min. <input type="checkbox"/> r/min.
Unit display LED ■ : Illuminates or flashes	Output current (Flashes) PRG.MODE <input type="checkbox"/> <input type="checkbox"/> Hz <input type="checkbox"/> A <input type="checkbox"/> V <input type="checkbox"/> r/min. <input type="checkbox"/> r/min.	Output voltage (Illuminates) PRG.MODE <input type="checkbox"/> <input type="checkbox"/> Hz <input type="checkbox"/> A <input type="checkbox"/> V <input type="checkbox"/> r/min. <input type="checkbox"/> r/min.	Output voltage (Illuminates) PRG.MODE <input type="checkbox"/> <input type="checkbox"/> Hz <input type="checkbox"/> A <input type="checkbox"/> V <input type="checkbox"/> r/min. <input type="checkbox"/> r/min.			
	Motor speed setting (Flashes) PRG.MODE <input type="checkbox"/> <input type="checkbox"/> Hz <input type="checkbox"/> A <input type="checkbox"/> V <input type="checkbox"/> r/min. <input type="checkbox"/> r/min.	Motor speed (Illuminates) PRG.MODE <input type="checkbox"/> <input type="checkbox"/> Hz <input type="checkbox"/> A <input type="checkbox"/> V <input type="checkbox"/> r/min. <input type="checkbox"/> r/min.				
	Line speed setting (Flashes) PRG.MODE <input type="checkbox"/> <input type="checkbox"/> Hz <input type="checkbox"/> A <input type="checkbox"/> V <input type="checkbox"/> r/min. <input type="checkbox"/> r/min.	Line speed (Illuminates) PRG.MODE <input type="checkbox"/> <input type="checkbox"/> Hz <input type="checkbox"/> A <input type="checkbox"/> V <input type="checkbox"/> r/min. <input type="checkbox"/> r/min.				

Display	Mode	STOP mode	RUN mode	Program mode while stopped	Program mode while running	TRIP mode
RUN □ RUN display		• Off	• Illuminated	• Off	• Illuminated	• Off
PANEL CONTROL □ Operation command selection		• Illuminates when keypad panel operation mode selected (F02: 0) • Off when terminal operation mode selected (F02: 1)	• Illuminates when keypad panel operation mode selected (F02: 0) • Off when terminal operation mode selected (F02: 1)	• Illuminates when keypad panel operation mode selected (F02: 0) • Off when terminal operation mode selected (F02: 1)	• Illuminates when keypad panel operation mode selected (F02: 0) • Off when terminal operation mode selected (F02: 1)	• Off

(b) Key operations

Display	Mode	STOP mode	RUN mode	Program mode while stopped	Program mode while running	TRIP mode
P R G RESET		• Switches to program mode		• Switches to STOP mode	• Switches to RUN mode	• Resets a trip
FUNC DATA		• Switches the contents of the 7 seg. LED monitor display		• Switches the function code/data display • Writes data		• Not valid
∧ ∨		• Changes the frequency setting, motor speed setting and line speed setting • Displays the frequency setting		• Changes the function code or data		• Switches the trip history
RUN		• Starts operation (F02: 0) • Not valid (F02: 1)	• Not valid	• Not valid	• Not valid	• Not valid
STOP		• Not valid	• Stops operation (F02: 0) • Not valid (F02: 1)	• Not valid	• Stops operation (F02: 0) • Not valid (F02: 1)	• Not valid

11-3. Explanation of keypad panel operation

(1) STOP mode

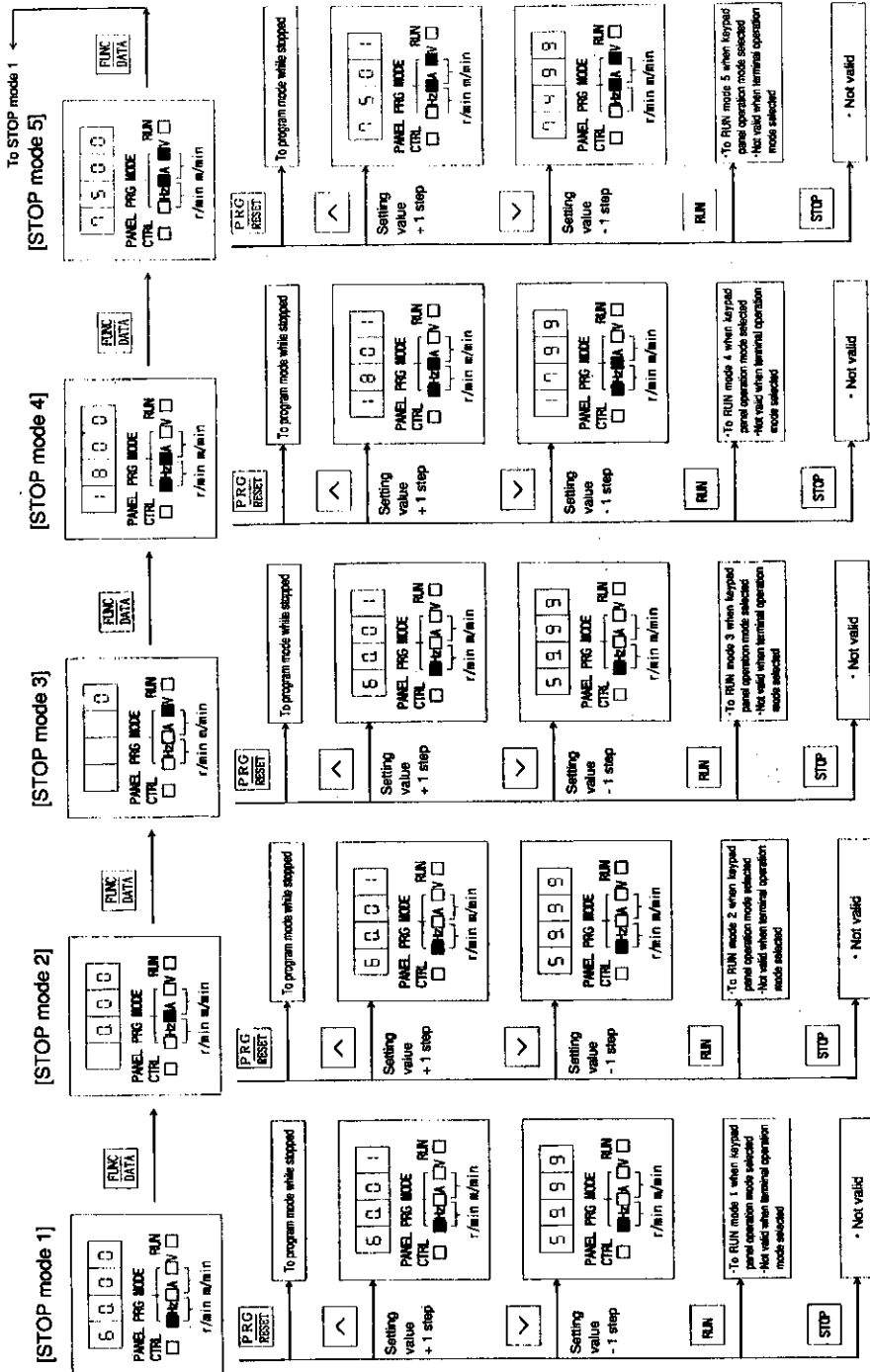

Note: The 7 seg. LED monitor display and unit display will illuminate.

(2) RUN mode

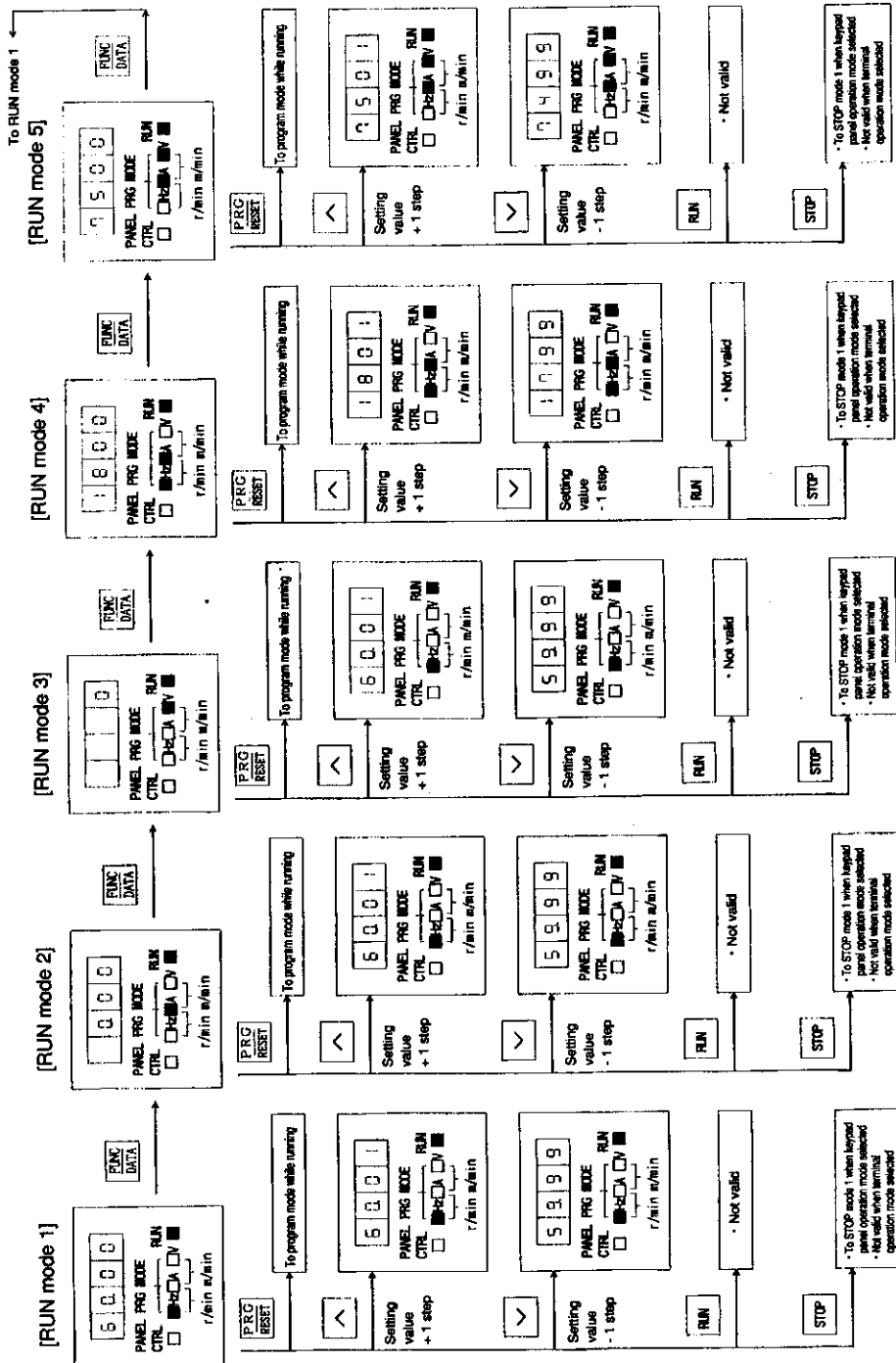

Note: The 7 seg. LED monitor display and unit display will flash.

(3) Program mode (when stopped or running)

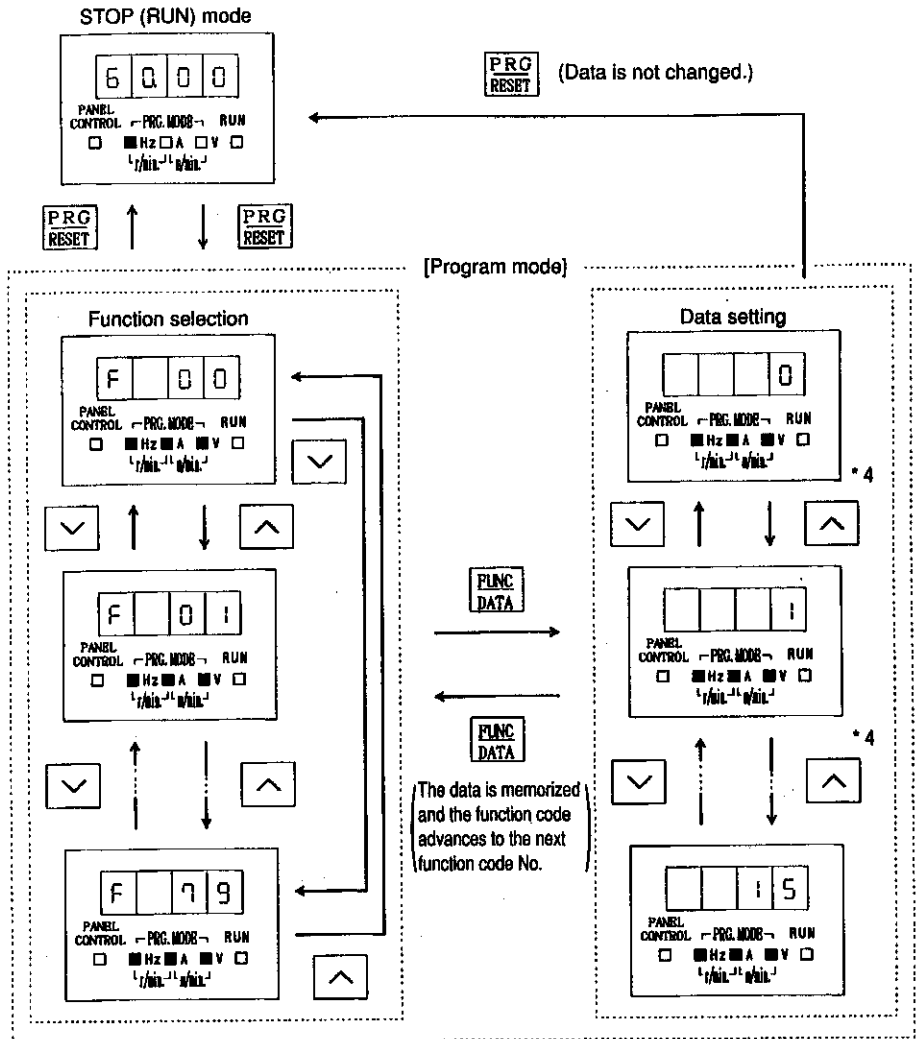

- *1 To change the data for functions F00 and F39, simultaneously press the **STOP** key and either the **▲** or **▼** key.
- *2 If the data for F39 is set to 1 and the **FUNC DATA** key is then pressed, the data for each function will be initialized to the factory default values. After initialization is completed, the keypad panel will be switch to STOP mode.
- *3 The unit display will illuminate during program mode while running, and it will flash during program mode while stopped.
- *4 The data settings for some functions cannot be changed even if the **▲** or **▼** key is pressed. For details on the functions that cannot be changed during Inverter operation, refer to 11-4 and 11-5 Description of Functions.
- *5 It takes a fixed amount of time for data which has been set or changed to be written to the Internal memory of the Inverter. Wait for at least 3 seconds after setting or changing data before turning off the Inverter power.

(4) TRIP mode

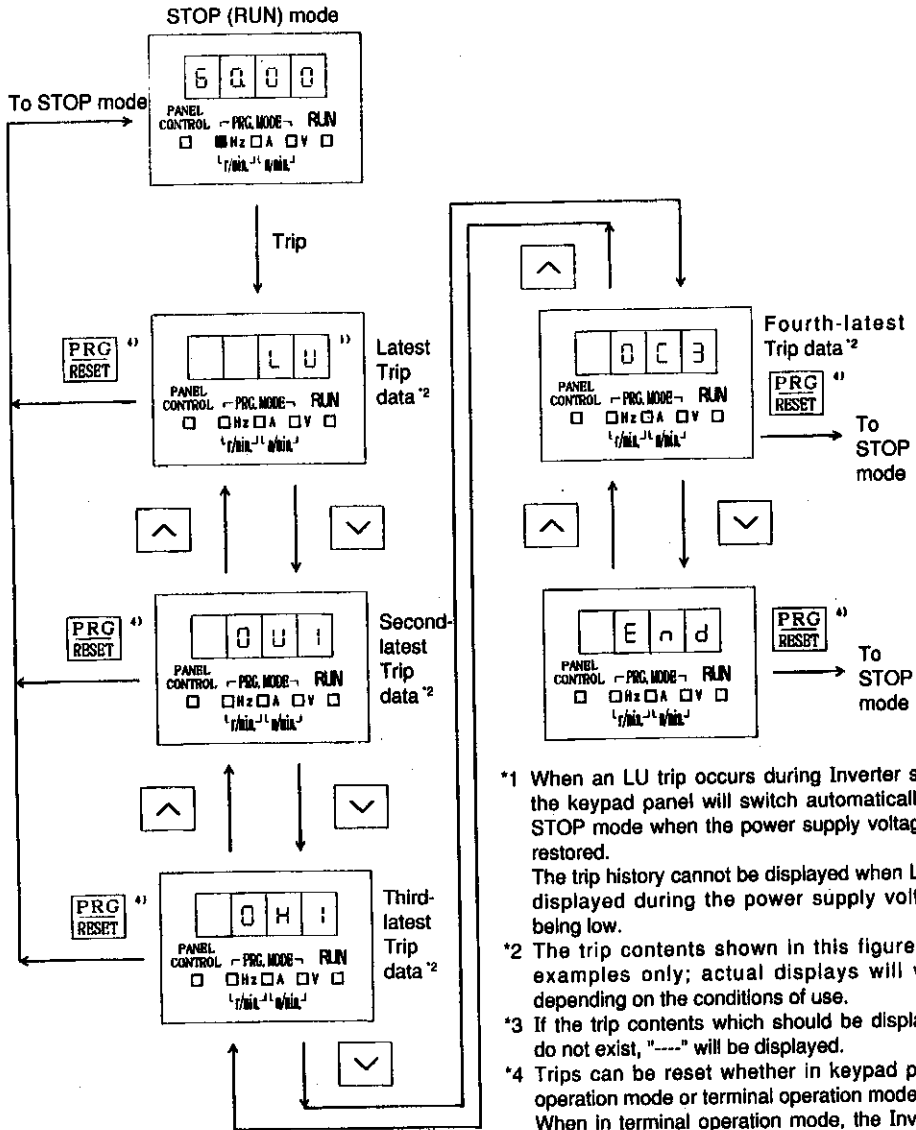

*1 When an LU trip occurs during Inverter stop, the keypad panel will switch automatically to STOP mode when the power supply voltage is restored.

The trip history cannot be displayed when LU is displayed during the power supply voltage being low.

*2 The trip contents shown in this figure are examples only; actual displays will vary depending on the conditions of use.

*3 If the trip contents which should be displayed do not exist, "----" will be displayed.

*4 Trips can be reset whether in keypad panel operation mode or terminal operation mode. When in terminal operation mode, the Inverter will suddenly restart if the trip is reset while either FWD or REV is ON. Check that the operation signal is not being input before carrying out the reset.



WARNING

● If an alarm reset is carried out while a run signal is being input, the Inverter will suddenly restart. Always check that the run signal is not being input before carrying out the alarm reset, otherwise accidents may occur.

11-4. Function table

Function		Setting range	Minimum unit	Unit	Change during operation	Factory setting	Page	
No.	Name							
0 0	Data protection	0 : Data changeable 1 : Change inhibited	—	—	×	0	35	
0 1	Frequency setting	0 : Using Keypad panel Keys 1 : Using analog signal input	—	—	×	0 (1) ^s		
0 2	Operation method	0 : Using Keypad panel 1 : Terminal operation	0	—	×	0 (1) ^s	36	
0 3	Maximum frequency	50 to 400	1	Hz	×	60 (50) ^d		
0 4	Base frequency 1	15 to 400	1	Hz	×	50		
0 5	Rated voltage (Max. output voltage)	0 : AVR function off	80 to 240/200V models	1	V	×	200 (220) ^d 400 (380) ^d	37
			160 to 480/400V models	2				
0 6	Acceleration time 1	0.00 to 3600	0.01 to 10	s	○	6.00		
0 7	Deceleration time 1					6.00		
0 8	Torque boost 1	0 : Automatic torque boost 1 to 31 : Manual torque boost	Code	—	○	0	38	
0 9	FMA voltage adjustment	0 (Approx.6.5V) to 99 (Approx.10.3V)	1	—	○	85		
1 0	Motor poles	2 : 2 poles, 4 : 4 poles, 6 : 6 poles, 8 : 8 poles, 10 : 10 poles, 12 : 12 poles	—	—	○	4		
1 1	Speed display coefficient	0.01 to 200.0	0.01, 0.1	—	○	0.01	39	
1 2	Motor operating sound adjustment (Carrier frequency)	0 to 15	1	kHz	○	15		
1 3	No. of retries	0 to 10	1	—	×	0		
1 4	Restart after momentary power failure (Operation selection)	0, 1 : Inactive, 2, 3 : Active	1	—	×	1	40	
1 5	(Operation selection)	0 : Inactive 1 : Active (Standard motor) 2 : Active (Fuji FV motor)	1	—	×	1 Rated value of Fuji standard 4-pole motor		
1 6	Electronic thermal overload relay 1 (Operating level)	0.01 to 99.9	0.01	A	×			
1 7	DC brake (Operation selection)	0 : Inactive, 1 : Active	0.1	—	×	0	41	
1 8	DC brake (Starting frequency)	0 to 60 (0.2Hz at 0 setting)	1	Hz	○	0		

()^s : without keypad panel model, ()^d : JE version

Function		Setting range	Minimum unit	Unit	Change during operation	Factory setting	Page
No.	Name						
1 9	DC brake (Braking level)	0 to 100	1	%	○	50	41
2 0	DC brake (Braking time)	0.00 to 30.0	0.01, 0.1	s	○	0.5	
2 1	Multistep frequency setting 1	0.00 to 99.99 100.0 to 400.0	0.01 0.1	Hz	○	10.00	43
2 2	Multistep frequency setting 2					20.00	
2 3	Multistep frequency setting 3					30.00	
2 4	Multistep frequency setting 4					40.00	
2 5	Multistep frequency setting 5					50.00	
2 6	Multistep frequency setting 6					60.00	
2 7	Multistep frequency setting 7					60.00	
2 8	S-curve acceleration/ deceleration (Operation selection)	0 : Inactive (linear acceleration/ deceleration) 1 : S-curve acceleration/ deceleration (weak) 2 : S-curve acceleration/ deceleration (strong)	0,1,2	—	×	0	44
2 9	Protection history	Last 4 protection operations are displayed in order	—	—	○	—	45
3 0	Starting frequency	0 to 15 (0.2Hz at 0 setting)	1	Hz	×	1	
3 1	(During acceleration/ deceleration)	0 : No limit	1	%	○	0	
3 2	Torque limit (At constant speed)	20 to 180 : Torque limit active				0	
3 3	Braking torque selection	0 : Low (no DB option) 1 : High (with DB option)	0.1	—	×	0	46
3 4	Bias frequency	—400 to 400	1	Hz	○	0	47
3 5	Gain for frequency setting signal	0.00 to 250.0	0.01,0.1	%	○	100.0	
3 6	Frequency limiter (High)	0 to 400	1	Hz	○	70	48
3 7						(Low)	
3 8	Motor characteristics	0 to 10	1	—	○	5	
3 9	Data initialization	0 : Manual setting 1 : Initial values (factory defaults)	1	—	×	0	

Function		Setting range	Minimum unit	Unit	Change during operation	Factory setting	Page				
No.	Name										
4 0	FMA,FMP terminals (Operation selection)	0 : Analog signal output from FMA terminal 1 : Pulse signal output from FMP terminal	—	—	×	0	49				
4 1	FMA terminal (Function selection)	0 : Output frequency 1 : Output current 2 : Output torque 3 : Load factor	1	—	×	0					
4 2	FMP terminal (Pulse rate multiplier)	10 to 100	1	—	○	24					
4 3	X4 terminal function	0 : RT 1, 1 : X 4 2 : VF 2, 3 : H L D	1	—	×	0	50				
4 4	Multistep frequency setting 8	0.00 to 99.99 100.0 to 400.0	0.01 0.1	Hz	○	0.00					
4 5	Multistep frequency setting 9					0.00					
4 6	Multistep frequency setting 10					0.00					
4 7	Multistep frequency setting 11					0.00					
4 8	Multistep frequency setting 12					0.00					
4 9	Multistep frequency setting 13					0.00					
5 0	Multistep frequency setting 14					0.00					
5 1	Multistep frequency setting 15					0.00					
5 2	Frequency setting signal filter					0.02 to 5.00		0.02	s	○	0.06
5 3	Timer					0 : Inactive, 0.01~3600(s)	0.01~10	s	×	0.00	
5 4	Y1 terminal (Function selection)	0 : Inverter running mode (RUN) 1 : Frequency level detection (FDT) 2 : Frequency equivalence signal (FAR) 3 : Undervoltage stop mode (LV) 4 : Torque limiting mode (TL) 5 : Auto-restart mode after momentary power loss (IP)	1	—	×	0	52				

Function		Setting range	Minimum unit	Unit	Change during operation	Factory setting	Page
No.	Name						
5 5	Frequency level detection (FDT operation level)	0.00 to 400.0	0.01 0.1	Hz	○	0.00	52
5 6	Hysteresis width	0 to 30	1	Hz	○	0	53
5 7	THR terminal (Function selection)	0 : THR function 1 : Edit permit command	1	—	×	0	
5 8	Jump frequency (Hysteresis width)	0 to 30	1	Hz	○	3	54
5 9	Jump frequency 1	0 to 400	1	Hz	○	0	
6 0	Jump frequency 2					0	
6 1	Jump frequency 3					0	
6 2	Base frequency 2	15 to 400	1	Hz	×	50	55
6 3	Acceleration time 2	0.00 to 3600	0.01 to 10	s	○	10.0	
6 4	Deceleration time 2					10.0	
6 5	Torque boost 2	1 to 31 : Manual torque boost	1	—	○	13	
6 6	(Operation selection) Electronic thermal overload relay 2	0 : Inactive 1 : Active(Standard motor) 2 : Active(Fuji FV motor)	1	—	×	0	55
6 7	(Operating level)	0.01 to 99.9	0.01	A	×	Rated value of Fuji standard 4-pole motor	
6 8	Slip compensation	0 : Inactive, 0.1 to 5.0	0.1	Hz	○	0.0	56
6 9	Torque vector control	0 : Inactive, 1 : Active	—	—	×	0	
7 0	Motor capacity	0 : 1-frame up capacity 1 : Standard capacity 2 : 1-frame down capacity 3 : 2-frame down capacity	1	—	×	1	57
7 1	Motor 1/rated current	0.01 to 99.9	0.01 0.1	A	×	Rated value of Fuji standard 4-pole motor	
7 2	Motor 1/no-load current						
7 3	Motor 2/rated current						
7 4	Automatic tuning	0 : Inactive, 1 : Active	—	—	×	0	

Function		Setting range	Minimum unit	Unit	Change during operation	Factory setting	Page
No.	Name						
7 5	Motor 1 (%R1 setting)	0.00 to 50.00	0.01	%	×	Rated value of Fuji standard 4-pole motor	57
7 6	Motor 1 (%X setting)						58
7 7	(At constant speed) Torque limiter response	000 to 999	-	-	○	369	59
7 8	(During acceleration/ deceleration)						
7 9	Option selection	0 : No options 1 : DI, 2 : DI/O, 3 : RS	0~3	-	×	0	

Change during operation { ○ : Change possible
× : Change impossible

11-5. Description of functions

This indicates that the data for the function cannot be changed during operation.
Change during operation
 appears if the data can be changed.

Indicates the factory default setting.

F 0:0

Data protection

~~Change during operation~~

0=0

- This setting function protects the setting data from unnecessary changes as a result of errors in operation.

0 : Data changeable

1 : Change inhibited (data protection)

To change the setting data, simultaneously press the STOP key and either the ▲ or ▼ key.

F 0:1

Frequency setting

~~Change during operation~~

0=0 : standard, 1 : without keypad panel

- The frequency setting method can be selected from the following.

0 : Using the keypad panel ▲ and ▼ keys

1 : Using analog signal input

The setting will be the sum of the values at terminal 12 (DC 0 to 10V) and terminal C1 (DC 4 to 20mA).

 **CAUTION**

- Because it is relatively easy to set the Inverter to high-speed operation, be sure to check the capacity of the motor and the equipment being operated before changing the Inverter function setting.

F 02

Operation method

~~Change during operation~~

☐ = 0 : standard, 1 : without keypad panel

- The input method for operation commands can be selected as follows.

☐☐☐0 : Operation command input using the keypad panel (RUN and stop commands using the [RUN] and [STOP] keys)

☐☐☐1 : Operation command input by means of external signal terminals (FWD, REV)

Operating mode	F 02	Panel Control LED
Keypad panel operation	☐☐☐0	Illuminated
Terminal operation	☐☐☐1	Off

NOTE

The data can be changed when the FWD and REV terminals on the terminal board are both OFF (while they are not being held in 3-wire operation).

The FWD and CM terminals are shorted with a shorting bar at the time of shipment. In this condition, the setting for function F02 cannot be changed. Remove the shorting bar while changing the setting.

F 03

Max. frequency

~~Change during operation~~

☐ = 60 Hz: standard, 50 Hz: JE version

- The maximum operation frequency can be set within the range 50~400Hz in steps of 1Hz.

**CAUTION**

- Because it is relatively easy to set the Inverter to high-speed operation, be sure to check the capacity of the motor and the equipment being operated before changing the Inverter function setting.

F 04

Base frequency 1

~~Change during operation~~

☐ = 50 Hz

- This sets the base frequency.
Exceeding this frequency, output voltage will be constant according to the setting value of Function F05.
The setting range is 15 to 400Hz in steps of 1Hz. It is normally set to the rated frequency of the motor.

NOTE

If the base frequency is greater than the maximum frequency, the output voltage will not rise to the rated voltage. Set so that the ratio between the base frequency and the maximum frequency is less than 1:8.

F 05

Rated voltage
(Max. output voltage)

Change during operation

☞ = 200V:200V models/400V:400V models / standard
220V:200V models/380V:400V models / JE

- This sets the maximum output voltage for the Inverter steps of 1V.
Data 0 : AVR function is off (output voltage is proportional to power supply voltage)
Other : The AVR function operates to control the maximum output voltage of the Inverter to the set voltage.

[setting range] 200V models: 80 to 240V
400V models: 160 to 480V

※ The output voltage cannot be higher than the voltage input from the power supply.

NOTE

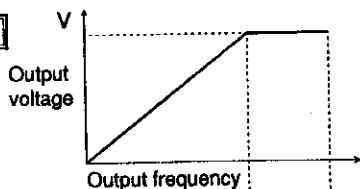

Maximum output voltage F05

Maximum frequency F03
Base frequency F04

F 06

Acceleration time 1

Change during operation ☞ = 6.00s

F 07

Deceleration time 1

Change during operation ☞ = 6.00s

- The time from start to maximum frequency (acceleration) and from maximum frequency to stop (deceleration) can be set within the range of 0.01 to 3600 seconds. Set values according to the load characteristics or GD².

Setting range	Setting step
0.00* to 9.99s	0.01s
10.0 to 99.9s	0.1s
100 to 999s	1s
1,000 to 3,600s	10s

* When set to 000, the time becomes 0.01 seconds.

NOTE

This function can be selected when F43 is set to 0 or 2 and X4-CM is off, or when F43 is set to 1 or 3.

F 08

Torque boost 1

Change during operation

09 = 0

- You can switch between automatic torque boost and manual torque boost mode according to the type of load and the motor characteristics, and adjust the torque boost value in manual mode to one of 31 values.

0000 : Torque boost is automatically controlled.

0007 : Squared torque characteristics
(for fans and pumps)

0002 : Proportional torque characteristics

0003 : (Weak)

⋮

0031 : (Strong)

Manual

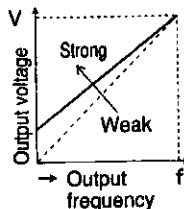

* Refer to "11-6-1 Description of torque boost" for details.

NOTE

If using a Fuji Inverter motor (FV motor), set to 0000.

F 09

FMA (Analog monitor) voltage adjustment

Change during operation

09 = 8 5

- This function adjusts the voltage level of the analog voltage signal from the FMA terminal.

0000 : Approx. 6.5V

⋮

0099 : Approx. 10.5V

The value can be adjusted to one of 100 settings within this range.

NOTE

This function is only active if F140 (FMA terminal output) is set to 0000. If the contents for function F140 have been changed, readjustment is necessary. Select the type of signal output from the FMA terminal by means of function F141 (FMA terminal function selection).

F 10

Motor poles

Change during operation

10 = 4

- This sets the number of poles of the motor being used for synchronized rotation speed display.

0002 : 2 poles, 0006 : 6 poles, 0010 : 10 poles

0004 : 4 poles, 0008 : 8 poles, 0012 : 12 poles

Example: If running a 4-pole motor at 60Hz, the display will be $120 \times 60 \div 4 = 1800$

F 1 1

Speed display coefficient

Change during operation

☞ = 0.01

- This sets the display coefficient for displaying the line speed [m/min.]
 Display value [m/min.] = Output frequency [Hz] x display coefficient

Display coefficient setting range	Setting step
0.01 to 9.99	0.01
10.0 to 200.0	0.1

F 1 2

Motor operating sound adjustment
(Carrier frequency)

Change during operation

☞ = 15kHz

- This adjusts the carrier frequency of the Inverter within the range of 0.75~15kHz. The acoustic and electromagnetic noise generated by the motor can be reduced by adjusting the carrier frequency.
 If set to , the carrier frequency will be set to 0.75kHz.
 The adjustment from 1 to 15kHz can be carried out in 1kHz steps.

F 1 3

No. of retries

~~Change during operation~~

☞ = 0

- This sets the number of times the Inverter automatically tries to restart after a trip caused by overcurrent within the range of 0 to 10 times.
 Retries are only carried out for trips which occur as a result of overcurrent.
 This does not operate for output grounding fault or short circuits.



WARNING

- If the retry function has been activated and a trip occurs, the Inverter will restart automatically depending on the cause of the trip.
Make sure that the system is set up properly so that there will be no danger to personnel when the Inverter starts, otherwise accidents may occur.

F 14

Restart after momentary power failure
(Operation selection)

~~Change during operation~~
= 1

- This sets the operation mode when a momentary power failure occurs and when power is restored.

- 0 : Inactive (Does not restart and immediate LU trip)
- 1 : Inactive (Does not restart and LU trip after recovery)
- 2 : Active (Restarting at frequency at time of power failure)
- 3 : Active (Restarting at frequency = 0)

NOTE Of the inactive settings, 0 emphasizes protective function, and 1 emphasizes continuous operation. 3 is for loads with low moment of inertia.



WARNING

- If restarting (data 2 or 3) is selected for the restart after momentary power failure function, the Inverter will restart after power is restored.

F 15

Electronic thermal
overload relay 1
(Operation selection)

~~Change during operation~~ , = 1

F 16

Electronic thermal
overload relay 1
(Operation level)

~~Change during operation~~ , = Rated value for
Fuji standard
4-pole motor

- This sets whether the electronic thermal overload relay (motor overload detection) for protecting the motor from overheating is active or inactive, what kind of motor is being used, and what the operation level is.

- [Operation selection] 0 : Inactive
- 1 : Active (Standard motor)
- 2 : Active (Fuji FV motor)

[Operation level] This sets the operation level of the electronic thermal overload relay in terms of current [A]. The setting range is within 20 to 105% of the Inverter rating.

F 17
 F 18
 F 19
 F 20

DC brake (Operation selection)
 DC brake (Starting frequency)
 DC brake (Braking level)
 DC brake (Braking time)

Change during operation $\text{☐} = 0$
 Change during operation $\text{☐} = 0\text{Hz}$
 Change during operation $\text{☐} = 50\%$
 Change during operation $\text{☐} = 0.5\text{s}$

- This sets the whether the DC injection brake is active or inactive, and also sets the operating specifications.

[Operation selection] : This switches the DC brake operation to active or inactive.

: Inactive (Regenerative braking only)

: Active (DC braking after regenerative braking)

[Starting frequency] : This sets the frequency at which to start DC injection brake operation during deceleration.

[Braking level] : This sets the braking level (brake output) for the DC injection brake in terms of the DC current calculated from the rated Inverter current.

The braking force will vary depending on the characteristics of the motor.

[Braking time] : This sets the operation time for the DC injection brake.

	Setting range	Unit	Setting step
Starting frequency	0 ¹⁾ to 60	Hz	1Hz
Braking level	0 to 100	%	1%
Braking time	0.00 to 9.99	s	0.01
	10.0 to 30.0		0.1

¹⁾ If the data is set to "0", the frequency will be 0.2Hz.

NOTE

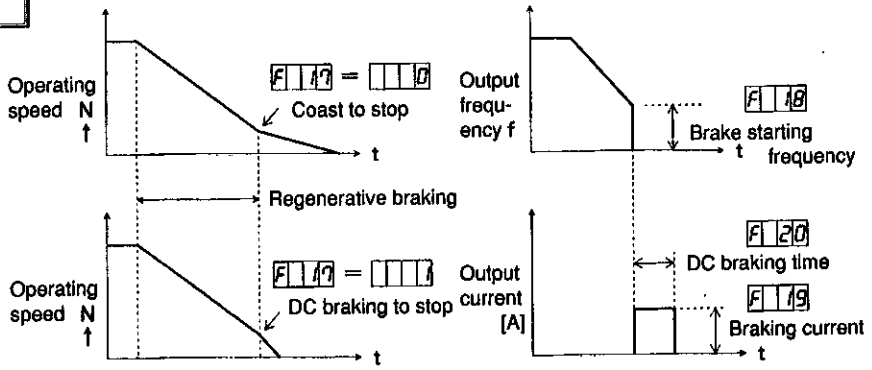

CAUTION

● The Inverter braking function cannot be substituted for mechanical means. Attempting to do so may result in injury.

F 2.1
F 2.2
F 2.3
F 2.4
F 2.5
F 2.6
F 2.7

Multistep frequency setting 1
Multistep frequency setting 2
Multistep frequency setting 3
Multistep frequency setting 4
Multistep frequency setting 5
Multistep frequency setting 6
Multistep frequency setting 7

Change during operation \Rightarrow =10.00Hz
Change during operation \Rightarrow =20.00Hz
Change during operation \Rightarrow =30.00Hz
Change during operation \Rightarrow =40.00Hz
Change during operation \Rightarrow =50.00Hz
Change during operation \Rightarrow =60.00Hz
Change during operation \Rightarrow =60.00Hz

- This sets the frequencies for multistep frequency operation. The frequencies to set are selected as shown in the table below by setting control terminals X1, X2 and X3 to on.

[Relationship between terminals

and multistep frequencies 1 - 7] ● : ON

Function	0 1	2 1	2 2	2 3	2 4	2 5	2 6	2 7
Multistep frequency	Speed 0	Speed 1	Speed 2	Speed 3	Speed 4	Speed 5	Speed 6	Speed 7
X 1 - CM		●		●		●		●
X 2 - CM			●	●			●	●
X 3 - CM					●	●	●	●

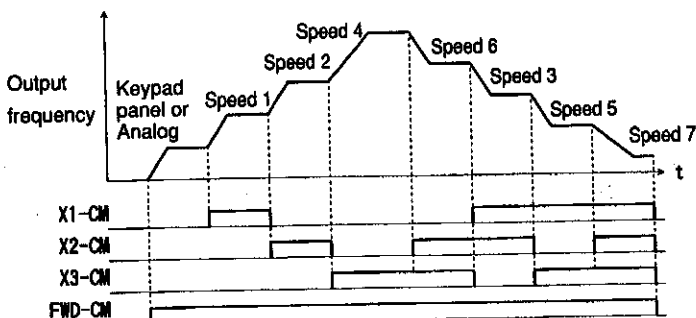

- (1) Speed 0 (when X1-CM, X2-CM and X3-CM are all off) depends on the frequency setting method selected by means of function $F 0 1$. In other words, the setting becomes digital (using the \wedge and \vee keys) or analog ($[DC 0 \text{ to } 10V] + [DC 4 \text{ to } 20mA]$).
- (2) The actual operation frequency is limited by the maximum frequency $F 0 3$ and the frequency limiters $F 3 6$ and $F 3 7$.

F 2.8

S-curve acceleration/deceleration
(Operation selection)

Change during operation
= 0

- This selects whether S-curve acceleration/deceleration is active or inactive, and which of the two S-curve acceleration/deceleration patterns is used.

0 : Inactive ... linear acceleration and deceleration¹⁾

1 : S-curve acceleration/deceleration (weak)

2 : S-curve acceleration/deceleration (strong)

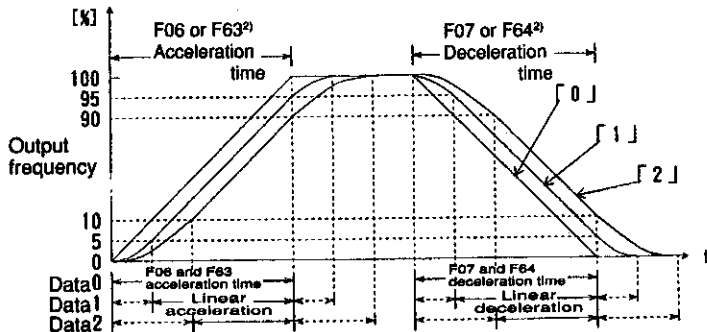

NOTE

- ① Shocks at the start and end of acceleration and deceleration can be softened by selecting a S-curve pattern.
- ② The maximum gradient in the output frequency when a S-curve pattern is selected is the same as for linear acceleration and deceleration time.
- ③ The actual acceleration and deceleration times when an S-curve pattern is selected is extended by 10% (when 1 is set) or 20% (when 2 is set) from the times set by F 06 and F 07 or by F 63²⁾ and F 64²⁾

1) Acceleration and deceleration are carried out at the uniform rate for the time specified by functions F 06 and F 07 or by F 63²⁾ and F 64²⁾

2) Selected when the terminal X4 function is set so that F 43 = 0 and X4 (RT_i) is ON.

F 2:9

Protection history

Change during operation

☞ = -

- The Last 4 protective operations are displayed in order when the key is pressed.

— Operation procedure —

	Procedure	Display example	Remarks
1	Call up F 2:9	F 2:9	
2	Press the <input type="checkbox"/> FUNC DATA key. ↓		
3	Press the <input checked="" type="checkbox"/> key. ↓	000	Contents of the latest trip are displayed
4	Press the <input checked="" type="checkbox"/> key. ↓	0H2	Contents of the second-latest trip are displayed
5	Press the <input checked="" type="checkbox"/> key. ↓	0C1	Contents of the third-latest trip are displayed
6	Press the <input checked="" type="checkbox"/> key. ↓	- - -	Contents of the fourth-latest trip are displayed
7		End	This example shows there is no trip history for this.

※ New trip histories are stored in the "latest trip contents" data area, existing trip histories are moved down one in the order, and the old fourth-latest history is deleted.

F 3:0

Starting frequency

Change during operation

☞ = 1 Hz

- This sets the starting frequency within the range of 0 to 15Hz in 1Hz steps.
If the data is set to 000, the frequency will be 0.2Hz.

F 3:1

Torque limit (During acceleration/deceleration)
Torque limit
(At constant speed)

Change during operation,

☞ = 0 %

F 3:2

Change during operation,

☞ = 0 %

- This sets the torque limit level during acceleration/deceleration and constant-speed operation in steps of 1%.

000 : No limit
020 : 20 %
:
180 : 180 %

} Limit

※ Refer to "11-6-2 Description of torque limit" for details.



WARNING

- If the torque limit function has been selected, the Inverter may start running with differences in the acceleration/deceleration time and speed settings. Make sure that the system is set up properly so that there will be no danger to personnel when the Inverter starts, otherwise accidents may occur.

F 3 3

Braking torque selection

Change during operation

0 = 0

- This sets the limit level for braking torque in accordance with the brake being used.

0 0 0 : Low (no DB option)

1 1 1 : High (with DB option)

Always connect an external braking resistor.

- ※ Refer to "11-6-3 Description of braking torque selection" for details.

F 3 4

Bias frequency

Change during operation

0 = 0 Hz

- This function adds the bias frequency to the analog setting frequency to produce the output frequency.

The setting range is between -400 to +400Hz in steps of 1Hz.

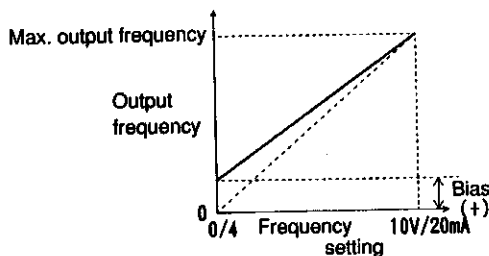

- ※ The bias frequency is only active when the frequency setting function F 0 1 = 0 0 0



WARNING

- If the bias frequency has been set, the Inverter will operate when an operation command is given, even if the analog frequency is zero.

F 3:5

Gain for frequency setting signal

Change during operation

$\Delta = 100.0\%$

- This sets the size (gradient) of the output frequency corresponding to the analog frequency setting as a percentage of the maximum frequency.

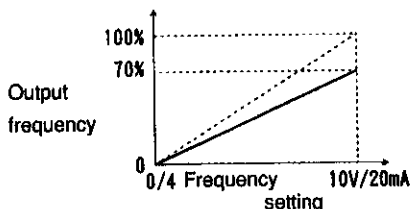

[Example: for 70% gain]

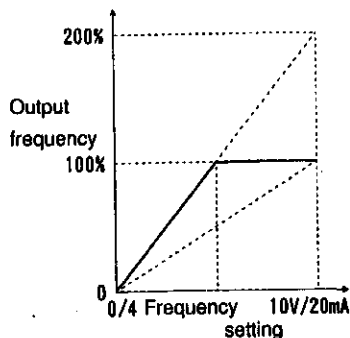

[Example: for 200% gain]

※ The gain setting is only active when $F 0 0 1 = \square \square \square \square$

Explanation

If the bias frequency function (F34) and the gain for frequency setting signal function (F35) are used together, the gain for frequency setting signal has priority, and the bias is applied to the frequency with gain already applied. The bias frequency f_{bias} and setting frequency gain at this time can be calculated by the following formulas.

$$f_{bias} = f_1 - \frac{f_1 - f_2}{v_1 - v_2} \times v_1$$

$$Gain = \frac{1000 \times (f_1 - f_2)}{100 \times (v_1 - v_2) + f_1 \times v_2 - f_2 \times v_1}$$

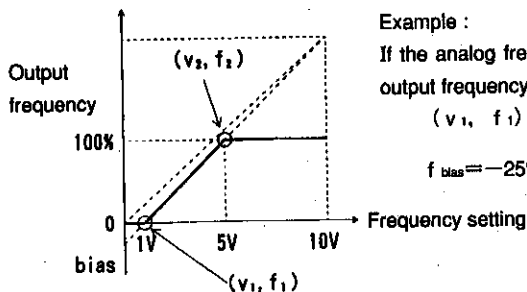

Example :

If the analog frequency setting voltage is 1 to DC 5V and the output frequency is weighted to 0 to 100%, then:

$(v_1, f_1) = (1, 0)$, $(v_2, f_2) = (5, 100)$ so that
[V] [%] [V] [%]

$f_{bias} = -25\%$, and $Gain = 200\%$

F 3.6

Frequency limiter (High)

Change during operation

= 70Hz

F 3.7

Frequency limiter (Low)

Change during operation

= 0Hz

- The high and low limits for the output frequency can be set within a range of 0 to 400Hz in steps of 1Hz.

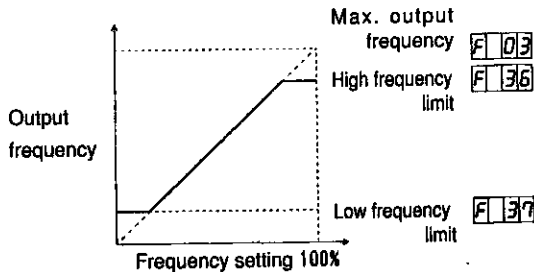
**NOTE**

If the high and low limit settings are reversed, the high limit has priority and the low limit is ignored. In this case, operation covers the whole range with the high limit, regardless of the input signal.

F 3.8

Motor characteristics

Change during operation

= 5

- This adjusts the output current in cases where there is an irregularity such as current fluctuation. If a current fluctuation occurs, adjust the setting value while referring to the tables below.

No. of motor poles	Many ↔ 4 ↔ Few
Setting	0 1 0

Load	High ↔ Low
Setting	0 1 0

F 3.9

Data initialization

Change during operation

= 0

- This sets the setting data for all functions to the factory default settings.

□□□0 : Inactive (manual setting)

□□□1 : Initial values (Initialization with factory defaults)

- [Operation procedure]
- When □□□0 is being displayed, press the **STOP** + **^** keys simultaneously to change the display to □□□1.
 - In this condition, press the **FUNC DATA** key to reset all data to the factory default settings. The display will then automatically switch to show the frequency setting for STOP mode.

F 4 0

FMA, FMP terminals
(Operation selection)

Change during operation

= 0

- This switches the output destination for the external monitoring signal.
 - 0 : Analog signals are output from the FMA terminal.
(The FMP terminal is not used.)
The type of analog signal output to the FMA terminal is selected by function F 4 1.
 - 1 : Pulse signals are output from the FMP terminal.
(The FMA terminal is not used.)
Frequency of pulse signal output to the FMP terminal is adjusted by function F 4 2.

F 4 1

FMA terminal
(Function selection)

Change during operation

= 0

- This sets the type of analog signal which is output to the FMA terminal.
 - 0 : Output frequency $\text{Display } 100\% = \frac{\text{Output frequency}}{\text{Maximum frequency}} \times 100$
 - 1 : Output current $\text{Display } 100\% = \frac{\text{Output current}}{\text{Rated inverter current} \times 2} \times 100$
 - 2 : Output torque $\text{Display } 100\% = \frac{\text{Output torque}}{\text{Rated torque} \times 2} \times 100$
 - 3 : Load factor $\text{Display } 100\% = \frac{\text{Inverter output}}{\text{Rated output} \times 2} \times 100 \quad (f > f_{\text{base}})$
 $= \frac{\text{Output torque}}{\text{Rated torque} \times 2} \times 100 \quad (f \leq f_{\text{base}})$
- f : Output frequency, f_{base} : Base frequency

F 4 2

FMP terminal
(Pulse rate multiplier)

Change during operation

= 2 4

- This sets the pulse rate multiplier for the pulse signal frequency output to the FMP terminal with respect to the Inverter output frequency. The setting range is 1 to 100.

$$\left[\begin{array}{l} \text{FMP terminal} \\ \text{pulse frequency} \end{array} \right] = \left[\begin{array}{l} \text{Inverter output} \\ \text{frequency} \end{array} \right] \times [\text{Pulse rate multiplier}]$$
- ※ Set so that the frequency output from the FMP terminal is 6kHz or lower.

F 4 3

X4 terminal function

Change during operation

0 = 0

- The function for the X4 input terminal can be selected from the following four options.

0 0 0

: Functions as a command input terminal (RT1) for switching to acceleration/deceleration time 2.

The acceleration time 2 and deceleration time 2 are set by F 6 3 and F 6 4.

0 0 1

: Functions as a No. 4 signal (X4) for multistep frequency operation command input.

When using as this function, operation is possible with a total of 16 frequencies.

Frequencies 8 to 15 are set by means of F 4 4 to F 5 A.

0 0 2

: Functions as a command terminal (VF2) for switching to base frequency 2 when using the second motor, etc.

When base frequency 2 is selected, acceleration/deceleration time 2, torque boost 2 and electronic thermal overload relay 2 are selected simultaneously.

Base frequency 2 is set using function F 6 2, acceleration/deceleration time 2 are set by function F 6 3 and F 6 4, torque boost 2 is set by function F 6 5, and electronic thermal overload relay 2 is set by F 6 6 and F 6 7.

0 0 3

: Functions as a hold signal (HLD) for operation commands during 3-wire operation.

F 4 4

Multistep frequency setting 8

Change during operation,

0 = 0.00Hz

F 4 5

Multistep frequency setting 9

Change during operation,

0 = 0.00Hz

F 4 6

Multistep frequency setting 10

Change during operation,

0 = 0.00Hz

F 4 7

Multistep frequency setting 11

Change during operation,

0 = 0.00Hz

F 4 8

Multistep frequency setting 12

Change during operation,

0 = 0.00Hz

F 4 9

Multistep frequency setting 13

Change during operation,

0 = 0.00Hz

F 5 0

Multistep frequency setting 14

Change during operation,

0 = 0.00Hz

F 5 1

Multistep frequency setting 15

Change during operation,

0 = 0.00Hz

- These set the 8 multistep frequencies from frequency 8 to frequency 15 within the range of 0 to 400Hz.

The setting step is the same as for functions F21 ~ F27.

[Relationship between terminals and multistep frequencies 8 ~15] ● : ON

Function	4 4	4 5	4 6	4 7	4 8	4 9	5 0	5 1
Multistep frequency	Speed 8	Speed 9	Speed 10	Speed 11	Speed 12	Speed 13	Speed 14	Speed 15
X 1 - CM		●		●		●		●
X 2 - CM			●	●			●	●
X 3 - CM					●	●	●	●
X 4 - CM	●	●	●	●	●	●	●	●

These functions are only active when **F 1 4 3** has been set to **0 0 1** (X4).

F 1 5 2

Frequency setting filter

Change during operation

$\Delta t = 0.06$ s

- This sets the time constant for the input filter in order to reduce the effects of noise included in the analog setting signal (voltage and current input). Settings can be made in steps of 0.02 second.

If the time constant is set too long, the response to analog commands will become poor.

F 1 5 3

Timer

Change during operation

$\Delta t = 0.00$ s

- This sets whether the timer is active or inactive, and also sets the time from the start of operation until operation automatically stops (when the timer is active).

0 0 0 : Inactive (normal operation)

0 0 1 : Active (0.01 second)

3 6 0 0 : Active (3,600 seconds)

Setting range	Setting step	Unit
0.00 to 9.99	0.01	second (s)
10.0 to 99.9	0.1	
100 to 999	1	
1000 to 3600	10	

F 5 4

Y1 terminal
(Function selection)

Change during operation

☞ = 0

- This selects the output signal for the Y1 terminal from the following 6 types.

□□□0

: Inverter running state (RUN)

This is OFF during direct current braking.

□□□4

: Frequency level detection (FDT)

Y1-CM is ON when the frequency detected is identical to the frequency set by function F 5 5 .

The hysteresis is set by function F 5 6 .

□□□2

: Frequency equivalence signal (FAR)

Y1-CM is ON when the frequency reaches the frequency set by the keypad panel, analog input, multistep frequency setting, etc.

The hysteresis is set by function F 5 6 .

□□□3

: Undervoltage stop mode (LV)

□□□4

: Torque limiting mode (TL)

□□□5

: Auto-restart mode after momentary power failure (IP)

F 5 5

Frequency level detection
(FDT operation level)

Change during operation

☞ = 0.00Hz

- This sets the operation level for FDT signal (frequency detection signal) output within the range of 0.00~400.0Hz.

[Setting resolution]

Setting range	Setting step	Unit
0.00 to 99.99	0.01	Hz
100.0 to 400.0	0.1	

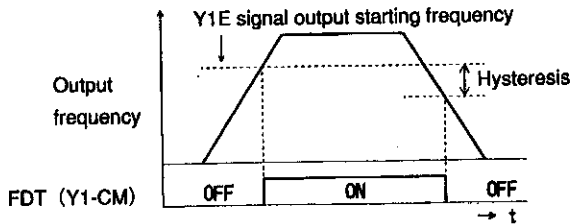

F 56**Hysteresis width****Change during operation**

0 Hz

- This sets the hysteresis for the frequency detection signal (FDT) and frequency equivalence signal (FAR) within the range of 0~30Hz.
For the frequency equivalence signal (FAR), the equivalent frequency is in the middle of the hysteresis width.

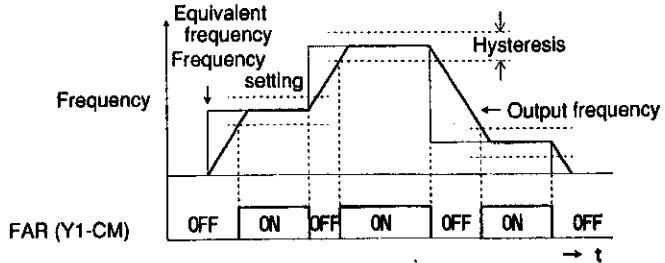
**F 57****THR terminal (Function selection)**~~Change during operation~~

0

- This sets the function for the THR input terminal.
 - : Used for THR functions (Trip command functions)
 - : Used for edit permit commands
- THR-CM off: Function data cannot be changed
 THR-CM on : Function data can be changed¹⁾

¹⁾ The relationship between this function and function **F 00** (Data protection) is shown in the table below.

F57: Edit permit command	F00: Data protection	Data changing possible
OFF	<input type="checkbox"/>	No
OFF	<input type="checkbox"/>	No
ON	<input type="checkbox"/>	Yes
ON	<input type="checkbox"/>	No

F 5 8

Jump frequency (Hysteresis)

Change during operation

☞ = 3Hz

F 5 9

Jump frequency 1

Change during operation

☞ = 0Hz

F 6 0

Jump frequency 2

Change during operation

☞ = 0Hz

F 6 1

Jump frequency 3

Change during operation

☞ = 0Hz

- This sets the three midpoints and the hysteresis for the jump frequencies which are used to prevent vibration from occurring at certain frequencies due to mechanical resonance between the load and the motor.

[Jump frequency hysteresis]... The hysteresis for the frequencies to be jumped can be set in steps of 1Hz.

[Jump frequency 1]
[Jump frequency 2]
[Jump frequency 3] } The midpoints for the frequencies to be jumped can be set in steps of 1Hz. ¹⁾²⁾

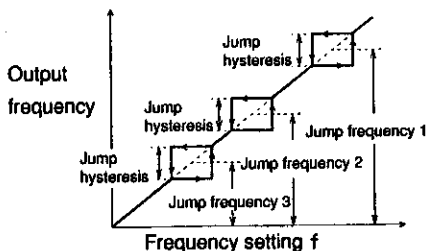

¹⁾ Even if jump frequencies have been set, they will be omitted during acceleration and deceleration.

²⁾ If a jump frequency is set to zero, the jump function becomes inactive.

F 6 2

Base frequency 2

~~Change during operation~~

☞ = 5 0 Hz

- This sets base frequency 2 to within the range of 15 to 400Hz in steps of 1Hz. It is used when the terminal X4 has been set to function as a command terminal for switching to base frequency 2 (F 4 3 = □ □ □).

NOTE

If the base frequency is greater than the maximum frequency, the output voltage will not rise to the rated voltage.

Set so that the ratio between the base frequency and the maximum frequency is less than 1:8.

F 6 3

Acceleration time 2

Change during operation,

☞ = 10.0 s

F 6 4

Deceleration time 2

Change during operation,

☞ = 10.0 s

- This sets the acceleration time 2 and deceleration time 2 when terminal X4 has been set to function as a command input terminal for switching to acceleration/deceleration time 2 (RT1: F 4 3 = □ □ □) or to base frequency 2 (VF2: F 4 3 = □ □ □).
- Setting details are the same as for function F 0 6 and F 0 7.

F 6 5

Torque boost 2

Change during operation

☞ = 1 3

- This sets the torque boost 2 to one of 31 patterns 1) when terminal X4 has been set to function as a command input terminal for switching to base frequency 2 (VF2: F 4 3 = □ □ □).

Setting details are the same as for function F 0 8.

1) For manual torque boost only; no pattern can be selected for automatic torque boost.

※ Refer to "11-6-1 Description of torque boost" for details.

F 6 6

Electronic thermal
overload relay 2

~~Change during operation~~, ☞ = 0

(Operation selection)

Electronic thermal
overload relay 2

~~Change during operation~~, ☞ = Rated value for
Fuji standard
4-pole motor

(Operation level)

- When terminal X4 has been set to function as a command input terminal for switching to base frequency 2 (VF2: F 4 3 = □ □ □), this sets whether the electronic thermal overload relay 2 (motor overload detection) for the second motor is active or inactive, and also sets the operation pattern and the operation level.

Setting details are the same as for function F 1 5 and F 1 6.

NOTE

Base frequency 2, torque boost 2 and electronic thermal overload relay 2 are only active when the X4 terminal function has been set to VF2 (F 4 3 = □ □ □) and X4-CM is ON (close).

F 68

Slip compensation

Change during operation

$f_{sc} = 0.0\text{Hz}$

- Slip compensation (F68) is a function which provides compensation for slippages which occur as a result of the motor load torque in order to control fluctuations in motor speed. (See the graph at right.)

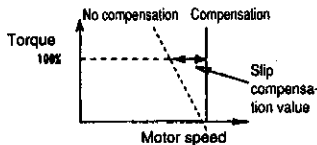

Slip compensation occurs as follows in accordance with the setting for this function.

F68 setting (slip compensation)	Slip compensation operation
0.0	Inactive
Other than 0.0	<p>Compensates in accordance with the slip compensation value which has been set. Obtain the setting value by using the following equation.</p> $\text{Slip compensation value} = \frac{(N_{B0} - N_{B1})}{N_{B0}} \times f_B$ <p> f_B : Base frequency 1 (F04) N_{B0} : Synchronized motor speed at base frequency N_{B1} : Motor speed under 100% load at base frequency (value on motor rating plate) </p>

F 69

Torque vector control

Change during operation

$f_{sc} = 0$

- This selects whether torque vector control is active or not.

0 : Torque vector control inactive

1 : Torque vector control active

※ Refer to "11-6-4 Description of torque vector control" for details.

F 70

Motor 1 capacity

Change during operation

$f_{sc} = 1$

- This set the capacity of the motor which is connected to the Inverter.

0 : 1-frame up capacity for standard applied motor

1 : Standard capacity for standard applied motor

2 : 1-frame down capacity for standard applied motor

3 : 2-frame down capacity for standard applied motor

F 7.1

Motor 1/rated current

~~Change during operation~~



Rated value for Fuji standard 4-pole motor

F 7.2

Motor 1/no-load current

~~Change during operation~~



- These set the rated current [A] and no-load current [A] for the motor which is connected to the Inverter.

Explanation

The primary resistance (R₁) and leakage reactance (X₁) are automatically rewritten with the rated value of the Fuji standard when motor capacity (F 7.0), motor 1/rated current (F 7.1) and motor 1/no-load current (F 7.2) are set.

F 7.3

Motor 2/rated current

~~Change during operation~~

= Rated value for Fuji standard 4-pole motor

- This sets the rated current [A] for the second motor which is selected when base frequency 2 (F 6.2) is active.

F 7.4

Automatic tuning

~~Change during operation~~

= 0

- This function is used to automatically tune the primary resistance (R₁) and leakage reactance (X₁) of the motor in order to perform the Torque Vector control.

: Inactive

: Automatic tuning

* Refer to "11-6-5 Description of automatic tuning procedure" for details.

F 7.5

Motor 1 (%R₁ setting)

~~Change during operation~~

= Rated value for Fuji standard 4-pole motor

- This function displays the primary resistance R₁ of the motor in terms of percentage, and manually sets its value.

The data can be overwritten and changed automatically by automatic tuning using function F 7.4, or by setting the motor capacity, rated current and no-load current using functions F 7.0 to F 7.2.

Calculation formula for %R₁

$$\%R_1 = \frac{R_1 + \text{cable } R}{V / (\sqrt{3} \cdot I)} \times 100 [\%]$$

R₁¹⁾, cable R : Ω

V : Rated voltage of motor

I : Rated current of motor

¹⁾ : Value calculated for star connection

F 7.6**Motor 1 (%XI setting)**~~Change during operation~~

☐ = Rated value for Fuji standard 4-pole motor

- This function displays the leakage reactance XI of the motor in terms of percentage, and manually sets its value.

The data can be overwritten and changed automatically by automatic tuning using function **F 7.4**, or by setting the motor capacity, rated current and no-load current using functions **F 7.0** to **F 7.3**.

Calculation formula for %XI

$$\%XI = \frac{X1 + X2 \cdot X_m / (X2 + X_m) + \text{Cable X}}{V / (\sqrt{3} \cdot I)} \times 100 \text{ [\%]}$$

X1¹⁾ : Primary inductance of motor 1 [Ω]X2¹⁾ : Secondary inductance of motor 1 [Ω]Xm¹⁾ : Mutual inductance of motor 1 [Ω]

Cable X : [Ω]

V : Rated voltage of motor

I : Rated current of motor

1) : Value calculated for star connection

**WARNING**

●%R1 and %XI should be set to values which are appropriate for the motor being used. The motor may not operate correctly if these values are not set correctly, which could result in accidents.

F 7.7

Torque limiter response
(At constant speed)

Change during operation , $\text{P} = 3\ 6\ 9$

F 7.8

Torque limiter response (During
acceleration/deceleration)

Change during operation , $\text{P} = 3\ 9\ 4$

- These functions set the response of the torque limiter functions during constant speed operation and during acceleration and deceleration.

000 ~ 999
 | | | | | |
 | | | | | | | |
 P I P I

	I (Quick)				(Slow)
P	0 0	.	.	.	9 9
0 (Low)					
.					
.					
9 (High)					

F 7.9

Option selection

~~Change during operation~~

$\text{P} = 0$





- This function sets whether an option is being used or not, and also what type of option is being used if any.

0 : No options
 1 : DI option card used
 2 : DI/O option card used
 3 : RS option card used

- ※ For details on setting specifications methods when using an option card, refer to the instruction manual which is supplied with the option card.

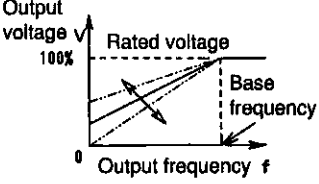
11-6-1. Description of torque boost

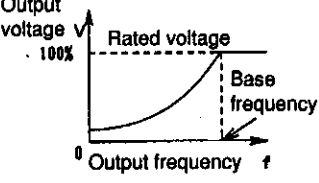
Torque boost is a function which boosts the torque which drops during low-speed operation by compensating for insufficient magnetic flux (torque) in the motor which occurs when the voltage drops in the low-frequency range.

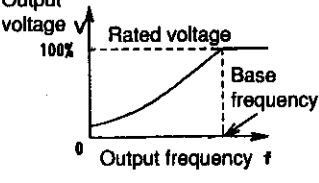
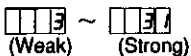
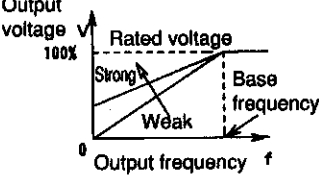
Torque boost classification	Torque boost setting details	Output voltage/output frequency characteristics
<p>Automatic torque boost (*1~*5)</p>	 <p>: Automatic torque boost Automatically adjusts the torque boost value for constant torque loads which change in a linear fashion.</p>	
	 <p>: Squared torque characteristics (for fan pump loads)</p>	
<p>Manual torque boost</p>	 <p>: Proportional torque characteristics (for intermediate loads between squared reduction torque and constant torque)</p>	
	 <p>(Weak) ~ (Strong) : Constant torque characteristics</p>	

- *1: If using this setting, be sure to set F70, F71, F72, F75 and F76 correctly.
- *2: Cannot be selected if F65 is set to "Torque boost 2".
- *3: Automatic torque boost cannot be used if more than one motor is being used. Use manual torque boost.
- *4: It may not be possible to obtain the full level of performance when using special motors such as high-speed motors. In such cases, use manual torque boost.
- *5: Refer to "Conditions for use of torque vector control and automatic torque boost" in "11-6-4. Description of torque vector control" for details of the conditions for using automatic torque boost.



WARNING

● If the torque boost value becomes large when constant torque characteristics have been set, overexcitation will occur. If operation continues in this state, it will cause the motor to overheat. Make the settings correctly in accordance with the characteristics of the motor being used.

11-6-2. Description of torque limit

Operation during torque limiting

During torque limiting, the frequency is controlled so that the torque does not exceed the torque limit values set by F31 and F32. *1

This operation allows operation to continue while the torque is maintained at the limit value.

However, if the load torque suddenly changes, the torque may momentarily exceed the limit value, or overcurrent or overvoltage protection may be activated.

*1) Actual operation is as follows.

Torque limit conditions	Operation during torque limit
During driving	Output frequency is reduced
During braking	Output frequency is increased (However, the maximum amount of increase is 5Hz.)

Conditions for use of torque limit

Use torque limit under the conditions where automatic torque boost operates *2.

If this is not done, large errors may occur in the torque calculation and torque limiting may not operate correctly.

*2) If not using VF2 when automatic torque boost (F108 = 0) or torque vector control operation (F69 = 1) is set



WARNING

●When the torque limiting function is being used, operation may occur at acceleration/deceleration times and speeds which are different to those that have been set. Make sure that the system is configured so that safety can be maintained even if this should happen, otherwise an accidents might result.

11-6-3. Description of braking torque selection

Braking torque selection (F33) is a function which lets you select the braking torque during torque limiting operation with or without external braking resistor

i) F33 = 0

The torque is limited so that it is at or below the allowable braking torque set according to standard specifications.

ii) F33 = 1

The torque is limited so that it is at or below the allowable braking torque when using an external braking resistor (DB option).

Note that braking torque selection (F33) cannot be used when the following functions have been set.

Function name	Function setting
Torque limit (during acceleration/deceleration)	F31 = <input type="checkbox"/> <input type="checkbox"/> <input type="checkbox"/> <input type="checkbox"/> 0 : No limiting
Torque limit (during constant speed)	F32 = <input type="checkbox"/> <input type="checkbox"/> <input type="checkbox"/> <input type="checkbox"/> 0 : No limiting



WARNING

●If an external braking resistor is not being used, be sure to set braking torque to low (F33 = 0), otherwise the torque limit function will not operate correctly and overvoltage trips will occur, and an accident may result.

11-6-4. Description of torque vector control

Caution when using torque vector control

When torque vector control is set to operate ($F169 = \square\square\square\square$), it operates as follows.

Function name	Function setting	Operation during torque vector control
Rate voltage value (F05)	$F105 = \square\square\square\square$: AVR function is OFF	The AVR function will be activated at the following settings. • When 200V series is set to 200V • When 400V series is set to 400V
	Other than $F105 = \square\square\square\square$: AVR function is ON	The AVR function will be activated at the F05 setting value.
Torque boost 1 (F08) *1	$F108$ All data	Operates in automatic torque boost mode.
Slip compensation not operating (F68)*2	$F168 = \square\square\square\square$: Slip compensation not operating	Slip compensation will operate at the value for Fuji standard 4P motor.
	Other than $F168 = \square\square\square\square$	Slip compensation will operate at the value of F68.

● Supplementary description

*1) When using a VF2, torque vector control will not operate even when $F169 = \square\square\square\square$.

*2) If using a motor other than Fuji standard 4P motor or if manual slip compensation has been set, the slip compensation setting should be $F168 = \square\square\square\square$ to $\square\square\square\square$.

Conditions for use of torque vector control and automatic torque boost

If any one of the conditions from ① to ④ cannot be satisfied, set torque vector control so that it does not operate $F169 = \square\square\square\square$, and set manual torque boost $F108 = \square\square\square\square$ to $\square\square\square\square$.

① Data for motor 1 (F70, F71, F72, F75, F76) should be set correctly.

Function code	Factory setting value
F70: Motor capacity	1
F71: Motor 1/Rated current	Rated value of Fuji standard 4P motor
F72: Motor 1/No-load current	
F75: Motor 1/%R1 setting	
F76: Motor 1/%X1 setting	

The data which has been set manually and the data which has been set automatically will be displayed as follows for each usage condition.

No.	Usage condition	Data entered manually	Data set automatically
1	When Fuji standard 4P motor is used	F 7 0	F71, F72, F75, F76
2	When a motor other than No. 1 is used	After entering in the order F70, F71 and F72, automatic tuning using F74.	F75, F76
3	If a reactor is connected between the inverter and the motor		

② The motor rated current should not be less than the inverter rated current.

The appropriate range to be set using F70 (Motor capacity) should be two frames less than the inverter capacity.

③ There should be one motor for each inverter.

If more than two motor is connected to an inverter, torque vector control will not operate correctly.

④ The cable length between the inverter and the motor should not exceed 50m.

If the cable is too long, the leakage current which flows via the static capacity to ground will affect control and tend to prevent control from being carried out correctly. Furthermore, control may not be carried out correctly even when an output circuit filter (OFL) is used.

11-6-5. Description of automatic tuning procedure

Automatic tuning is a function which automatically detects the motor's primary resistance %R1 (F75) and leakage reactance %X1 (F76).

Use automatic tuning if any one of the following three conditions can be met.

- ① A motor other than Fuji standard 4P motor is being used, and %R1 and %X1 cannot be ascertained
- ② The cable between the inverter and the motor is very long
- ③ A reactor has been connected between the inverter and the motor

Automatic tuning procedure

1. Connect the inverter and the motor according to the proper connection procedure.
2. Enter the appropriate data for the following functions in accordance with the characteristics of the motor being used.

Function code	Name	Setting range	Maximum frequency
F 0 3	Maximum frequency	50~400	60
F 0 4	Base frequency 1	15~400	50
F 0 5	Rated voltage (Maximum output voltage)	80~240 (200V series)	200
		160~480 (400V series)	400
F 7 0 ^(*)	Motor capacity	0~3	1
F 7 1 ^(*)	Motor 1/Rated current	0.01~9.99	Rated value of Fuji standard 4P motor
F 7 2 ^(*)	Motor 1/No-load current	0.01~99.9	

^(*) Be sure to enter in the order F70 → F71 → F72.

3. After checking that the inverter is stopped, carry out tuning by following steps 3-1 to 3-4 below.

3-1. Set automatic tuning to operate ($\boxed{F} \boxed{7} \boxed{4} = \boxed{\quad} \boxed{\quad} \boxed{\quad} \boxed{\quad}$).

3-2. Press the $\boxed{\text{FUNC DATA}}$ key to start automatic tuning.

3-3. The digital monitor on the keypad panel will show as follows during automatic tuning and immediately before and after tuning.

Automatic tuning condition	Digital monitor on keypad panel
Before tuning	$\boxed{\quad} \boxed{\quad} \boxed{\quad} \boxed{\quad}$ illuminates
During tuning	$\boxed{\quad} \boxed{\quad} \boxed{\quad} \boxed{\quad}$ flashes (for approx. 10 seconds)
After tuning	$\boxed{F} \boxed{7} \boxed{5}$ illuminates

3-4. The results of tuning can be checked using F75: %R1 and F76: %X1.

NOTE

- (i) Depending on the setting for $\boxed{F} \boxed{0} \boxed{2}$, emergency stopping may be caused by certain operations which are carried out during automatic tuning. ($\boxed{E} \boxed{F} \boxed{7}$ will be displayed in the digital monitor on the keypad panel.)

$\boxed{F} \boxed{0} \boxed{2}$ setting	Operation which causes $\boxed{E} \boxed{F} \boxed{7}$ display
Keypad panel operation : $\boxed{F} \boxed{0} \boxed{2} = \boxed{\quad} \boxed{\quad} \boxed{\quad} \boxed{\quad}$	• $\boxed{\text{STOP}}$ key is pressed
	• BX-CM terminals are closed (ON)
Terminal operation : $\boxed{F} \boxed{0} \boxed{2} = \boxed{\quad} \boxed{\quad} \boxed{\quad} \boxed{\quad}$	• $\boxed{\text{STOP}}$ key is pressed
	• BX-CM terminals are closed (ON)
	• FWD-CM terminals are closed (ON)
	• REV-CM terminals are closed (ON)

- (ii) If multiple motors are connected to a single inverter, or if an output circuit filter (OFL) is being used, automatic tuning calculations will not be carried out correctly. In such cases, set manual torque boost ($\boxed{F} \boxed{0} \boxed{8} = \boxed{\quad} \boxed{\quad} \boxed{\quad} \boxed{\quad}$ to $\boxed{\quad} \boxed{\quad} \boxed{\quad} \boxed{\quad}$).

12. Maintenance and Inspection

In order to achieve long periods of trouble-free operation and to prevent future problems, the following items should be inspected at least once between the indicated interval.

12-1. Daily Inspection

During operation and/or power up, check the operation of the Inverter visually without removing any covers to confirm that there are no abnormalities. The following points should always be checked.

- ① Check that the expected level of performance is being obtained (that performance meets specifications).
- ② Check that the ambient conditions satisfy the specifications.
- ③ Check that the keypad displays are normal.
- ④ Check that there are no abnormal noises, vibrations or odors.
- ⑤ Check that there are no signs of overheating or discoloration.

12-2. Periodic Inspection

Before carrying out periodic inspections, stop the Inverter, disconnect it completely from the power supply and then take off the front cover of the Inverter.

The smoothing capacitor will still be charged even after the power supply is turned off, and it takes some time for it to fully discharge. To avoid any danger, wait until the charge lamp has been extinguished, and then use a circuit tester to check that the voltage has dropped to a safe level (DC 25V or lower) before touching the power supply circuit.

Inspection should be carried out according to the items given in the periodic inspection list in Table 12-2-1.



- Wait at least five minutes after turning off the power before carrying out inspection. Check that the charge indication lamp has gone out, and also check that the DC voltage between the P and N terminals is less than 25V.
- Maintenance, inspection and part replacement should only be carried out by suitably qualified personnel.
Remove any metallic accessories such as watches and rings before starting work, and use only properly insulated tools, otherwise electric shocks may result.
- Do not carry out any modifications to the Inverter.
Doing so may result in electric shocks and injury.

12-3. Measuring main circuit power

The Inverter input/output voltage and current contain high harmonic components which may cause display errors with some measuring equipment. Because of this, if using a commercially-available measuring equipment, make sure that it is the type shown in Table 12-3-1.

Commercially-available power factor meters which measure the phase differences between voltages and currents cannot be used for measuring the power factor of the Inverter.

If power factor measurement is necessary, measure the power, voltage and current at both the input and output sides, and use them to calculate the power factor from the following formula.

① Three-phase

$$\text{Power factor} = \frac{\text{Electric power [W]}}{\sqrt{3} \times \text{Voltage [V]} \times \text{Current [A]}} \times 100 [\%]$$

② Single-phase

$$\text{Power factor} = \frac{\text{Electric power [W]}}{\text{Voltage [V]} \times \text{Current [A]}} \times 100 [\%]$$

12-4. Megger test

Insulation tests are carried out before shipment from the factory, so megger tests should be avoided if possible. If it is absolutely necessary to carry out a megger test, use the following procedure. Be careful not to make any mistake when carrying out this procedure, as damage to the Inverter may result.

In the same way as for megger tests, the Inverter may become damaged if withstand voltage tests are carried out incorrectly. If a withstand voltage test is necessary, contact the place of purchase or your nearest Fuji Electric office.

Table 12-2-1 Periodic inspection list

Inspection point	Inspection item	Inspection method	Judgement standard	
Ambient conditions	1)Check the ambient temperature, humidity, vibration and atmosphere (presence or absence of dust, gas, oil mists, dripping water, etc.). 2)Check that no tools or other potentially hazardous objects are placed nearby.	1)Check visually and with testing equipment. 2)Check visually.	1)Should satisfy standard specifications. 2)Should not be present.	
Voltage	Check that the main circuit and control circuit voltages are normal.	Measure with a circuit tester.	Should satisfy standard specifications.	
Keypad panel	1)Check that display is clearly visible. 2)Check that no characters are missing.	1),2)Check visually.	1),2)There should be no problem when reading the display.	
Structural parts such as frame and covers	1)Check for abnormal noise and vibration. 2)Check for looseness in bolts. 3)Check for damage and deformation. 4)Check for discoloration due to overheating or deterioration. 5)Check if the unit is dusty or dirty.	1)Check visually and aurally. 2)Tighten. 3),4),5) Check visually.	1),2),3),4),5) There should be no abnormality.	
Main circuit	Common	1)Check for loose or missing bolts. 2)Check for warps, cracks, damage and discoloration due to overheating or deterioration. 3)Check if the unit is dusty or dirty.	1)Tighten. 2),3)Check visually.	1),2),3)There should be no abnormality.
	Conductors & wiring	1)Check for discoloration or warping due to overheating. 2)Check for cracks, damage and discoloration of the wire covering.	1),2)Check visually.	1),2)There should be no abnormality.
	Terminal circuit board	Check for any damage.	Check visually.	There should be no abnormality
	Smoothing capacitor	1)Check that there is no dripping, discoloration, cracks or swelling. 2)Check that the safety valve does not jut out or excessively swollen. 3)Measure the capacitance if necessary.	1),2)Check visually. 3)Measure using a capacitance level meter. *1	1),2)There should be no abnormality. 3)Capacitance \geq rated value $\times 0.85$
	Resistors	1)Check for any abnormal odors or cracked insulation due to overheating. 2)Check for broken wires.	1)Check visually and by smelling. 2)Check visually or by disconnecting one end and measuring with a circuit tester.	1)There should be no abnormality. 2)Should be within $\pm 10\%$ of marked resistance.
	Transistors and reactors	Check for abnormal noise or smells.	Check visually, aurally and by smelling.	There should be no abnormality.
	Magnetic contacts and relays	1)Check for any chattering noise during operation. 2)Check for roughness in the contacts.	1)Check aurally. 2)Check visually.	1),2)There should be no abnormality.

Inspection point	Inspection item	Inspection method	Judgement standard
Control circuit board & connectors	1)Check for looseness in screws and connectors. 2)Check for abnormal odors and discoloration. 3)Check for cracks, damage, deformation and severe rust. 4)Check for dripping and traces of deformation in capacitors.	1)Tighten. 2)Check visually and by smell. 3),4)Check visually.	1),2),3),4)There should be no abnormality.
Cooling system	1)Check for abnormal noise and vibration.	1)Turn by hand (always with the power off) and check visually and aurally.	1),2),3)There should be no abnormality.
	2)Check for looseness of bolts.	2)Tighten.	
	3)Check for discoloration due to overheating.	3)Check visually.	
Cooling ports	Check for any blockages or foreign materials at the cooling fans or in the inlet and outlet ports.	Check visually.	There should be no abnormality.

*1 There are several easy-to-use capacitance meters generally available which can be used.

NOTE : If any parts are dirty, use a cloth and a chemically neutral detergent to wipe them clean.

Remove any dust with an electric vacuum cleaner.

Furthermore, the power should always be turned off before cleaning, in the same way as when carrying out periodic inspections. (Refer to "12-2. Periodic inspection" on page 64.)

[For 3-phase input series]

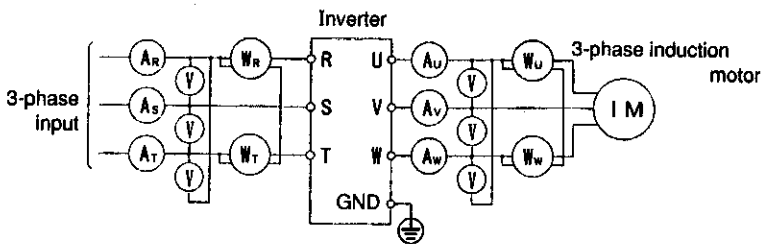

[For single-phase input series]

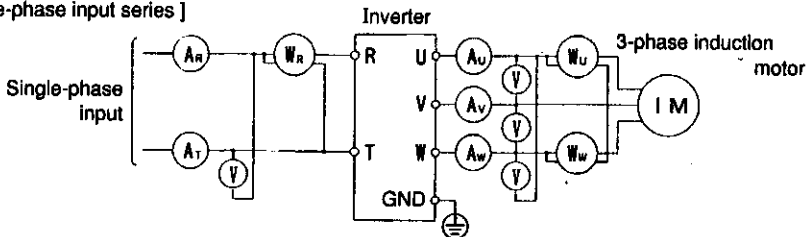
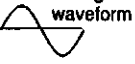
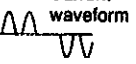
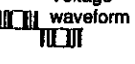
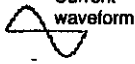







Fig. 12-3-1 Examples of main circuit measurement

Table 12-3-1 Meter for measuring the main circuit

Item	Input (power supply) side			Output (motor) side			DC circuit P(+), N(-) FM, 11 Terminal section
	Voltage waveform 	Current waveform 		Voltage waveform 	Current waveform 		
Meter name	Ammeter A _{R,S,T}	Voltmeter V _{R,S,T}	Wattmeter W _{R,T}	Ammeter A _{U,V,W}	Voltmeter V _{U,V,W}	Wattmeter W _{U,W}	DC voltmeter V
Meter type	Moving-iron type	Rectifier or moving-iron type	Power meter	Moving-iron type	Rectifier type (*1)	Power meter	Moving-coil type
Symbol			—			—	

(*1) When measuring the output voltage by rectifier type meter, an error may occur. Use a digital AC power meter for good accuracy.

(1) Main circuit

- ① Use a DC 250V megger for 200V series and a DC 500V megger for 400V series Inverters. If 200V series Inverters are tested using a DC 500V megger, accurate measurements may not be possible due to leakage current as a result of voltage characteristics of built-in surge absorber at the main circuit power supply (input).
- ② Disconnect all wires that are connected to terminal board of the main and control circuits and to external circuits.
- ③ Connect main circuit terminals R, S, T (R,T), P1, P(+), DB, U, V and W with a common wire as shown in Fig. 12-4-1.
- ④ Carry out the megger test between the main circuit common wire and the ground (ground terminal G(E) only.)
- ⑤ The condition is normal if the megger shows a resistance of 5MΩ or more.

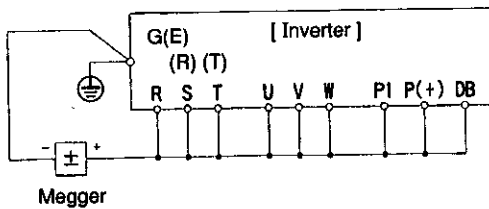

Fig.12-4-1 Megger test

(2) Control circuits

Do not carry out a megger test on the control circuits. If you do, irreparable burning and other damage to the circuit parts may result.

When conducting a conductivity test on the control circuits, use a high resistance range tester.

- ① Disconnect all external connections to the control circuit terminals.
- ② Test the conductivity between the circuits and the ground. The condition is normal if the measured value is 1 M Ω or more.

(3) External main circuit and sequence circuit

Disconnect all of the terminals on the Inverter so that the test voltage will not be applied to the Inverter.

12-5. Part replacement

The life of parts used in the Inverter depends on the type of parts. The life of these parts will also vary according to the environmental conditions and the conditions of usage. It is recommended that you use the information in Table 12-5-1 as a guide for parts replacement.

Table 12-5-1 Guide to parts replacement periods

Part name	Standard replacement interval	Replacement method/remarks
Cooling fans	3 years	Replace with new parts
Smoothing capacitor	5 years	Replace with a part (Determine after inspection)
Aluminum capacitor on printed circuit board	7 years	Replace with a new part (Determine after inspection)
Other parts	—	Determine after inspection

13. Troubleshooting

13-1. Protective function

- When the protective function is activated, the Inverter is immediately tripped (output stops), the cause of the trouble is displayed on the LED monitor and the motor coasts to a stop. For details on the alarms and the displays, refer to Table 13-1-1.
- The trip condition will continue until the cause of the trip is removed and the RESET Key is pressed or a reset command is input from the RST terminals of the control circuit.
- The last four trip events are stored in memory, and they can be checked using function F29. (For details of operation, refer to the explanation for the function F29.)
- While the activated protective function is displayed, the history of past protective function operations can also be viewed by continually pressing the key.

Table 13-1-1 Details of alarms and displays there of

Protective Function	Function Explanation	Display	Protective operation	
Overcurrent protection Short circuit Ground short circuit	Protects the Inverter if the Inverter output current momentarily exceeds the overcurrent detection level. Protects the Inverter from overcurrent resulting from a short circuit in the output circuit or ground circuit.	During acceleration	<ul style="list-style-type: none"> • Inverter output stops • Motor coasts to a stop • Alarm (1c) is output • Alarm signal is held internally until alarm reset command is given ¹⁾ 	
		During deceleration		OC2
		During steady speed operation		OC3
Momentary power failure Undervoltage protection	Avoids being out of control of the Inverter caused by drops in the input voltage level. ※Operation will continue if the momentary power failure or undervoltage period is less than 15 msec.	LU	<ul style="list-style-type: none"> • Inverter output stops • If the restart after momentary power failure mode is selected, operation will restart automatically when the power is restored 	
Overvoltage protection	Protects the Inverter if momentary overvoltage (regenerative overvoltage) which exceeds the overvoltage detection level is detected.	During acceleration	<ul style="list-style-type: none"> • Inverter output stops • Motor coasts to a stop • Alarm (1c) is output • Alarm signal is held internally until alarm reset command is given ¹⁾ 	
		During deceleration		OU2
		During steady speed operation		OU3
Inverter overheating	Detects overheating of the Inverter caused by an overload, cooling fan problem or abnormal ambient temperature.	OH1		
External alarm input	Acts as an external alarm to stop output, if protective device such as the electronic thermal overload relay connected between THR and CM terminals switches from on to off.	OH2		
Electronic thermal overload relay	Protects semiconductor devices such as the IGBT from overloads.	OLU		
	Protects Fuji standard 4-pole motors or Fuji FV motors from overloads even if an electronic thermal overload relay is not connected.	OL		

Protective Function	Function Explanation	Display	Protective operation
Memory error	Operates when a memory error occurs due to a data writing error, etc.	Er 1	<ul style="list-style-type: none"> • Inverter output stops • Motor coasts to a stop • Alarm (1c) is output • Alarm signal is held internally until alarm reset command is given ¹⁾
Communication error ²⁾	Displayed when there is communication error occurs continuously between the Inverter and the keypad panel.	Er 2	
CPU error	Stops the Inverter when an error is detected in the CPU.	Er 3	
Optional circuit board communication error	Displayed when there is a communication checksum error or interruption of communication between the Inverter and the optional circuit board.	Er 4	
Option problem	Displayed when a link error etc. is detected.	Er 5	
Output wiring error	Stops the Inverter when it is detected that the output wiring is not connected during automatic tuning.	Er 7	

¹⁾ Alarm signal holding

If the automatic breaker at the power supply side of the Inverter switches off when the protective function has operated and an alarm signal is being output, the control power supply for the Inverter is turned off and the alarm cannot be held internally.

²⁾ During external terminal operation (F02=1), the Inverter will continue running without an alarm being output even if error Er2 is displayed. If communication is restored, the Er2 display will disappear.

13-2. Troubleshooting when protective function operates

(1) Overcurrent (OC)

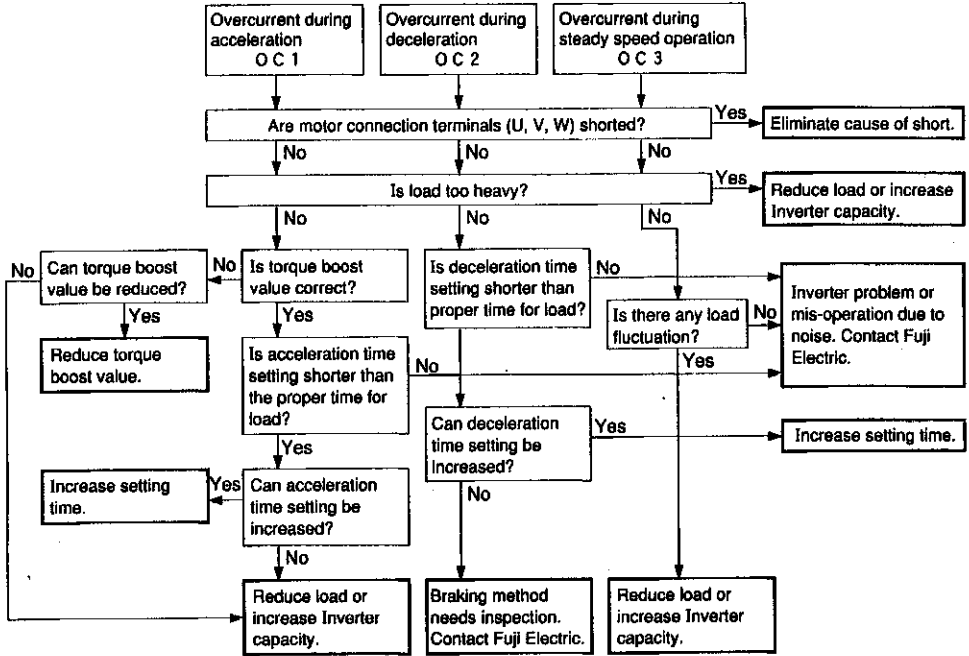

(2) Overvoltage (OU)

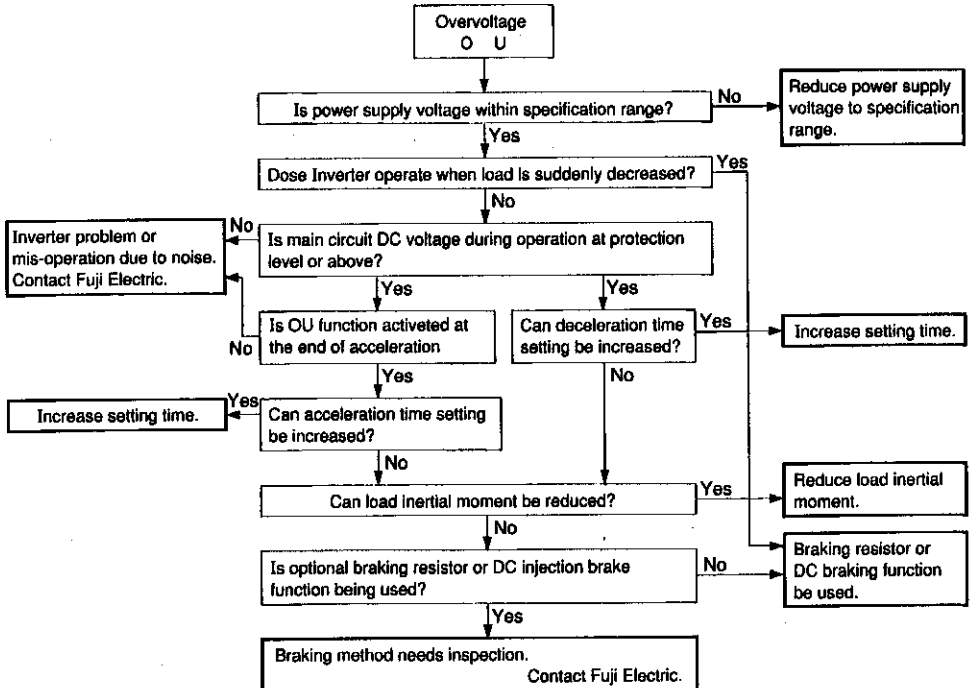

(3) Undervoltage (LU)^{1),2)}

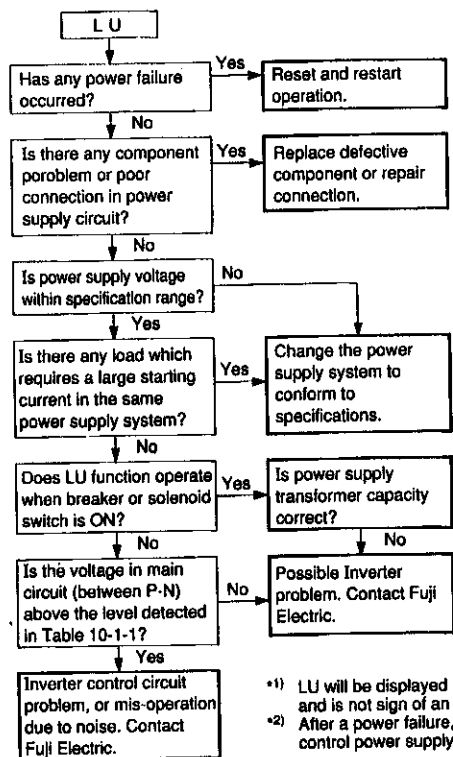

*1) LU will be displayed momentarily when the power supply is turned on, but this is normal and is not sign of an abnormality.

*2) After a power failure, once the smoothing capacitor has discharged and the Inverter control power supply has dropped, resetting will be made automatically.

(4) Inverter overloading or overheating (OH1)

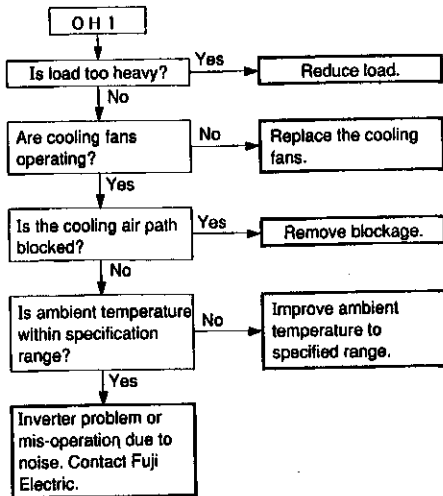

(5) External alarm input (OH2)

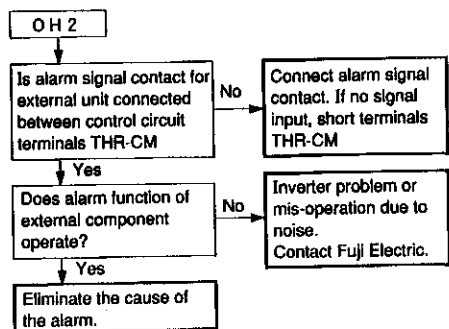

(6) Motor overload or Inver overload (OL)

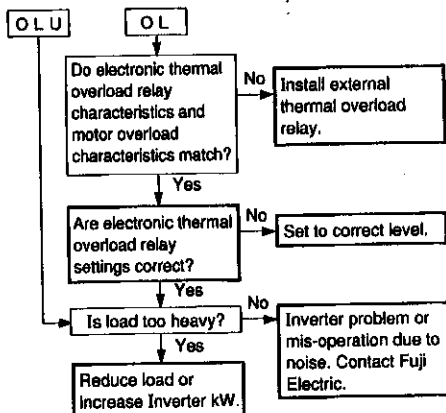

(7) Memory error, communication error or CPU error

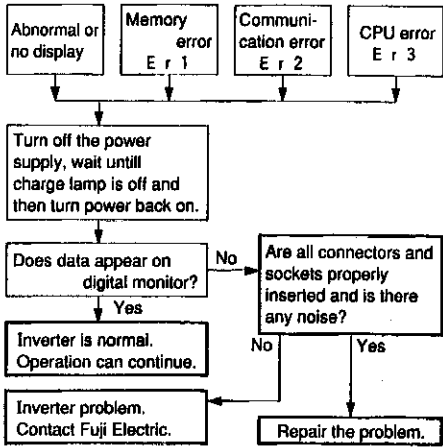

(8) Inverter output circuit error

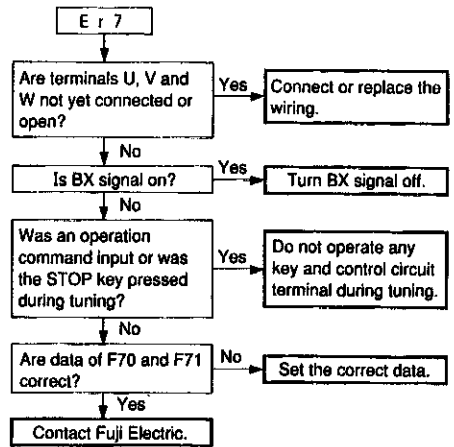

13-3. Troubleshooting when motor problem occurs

(1) Motor does not run

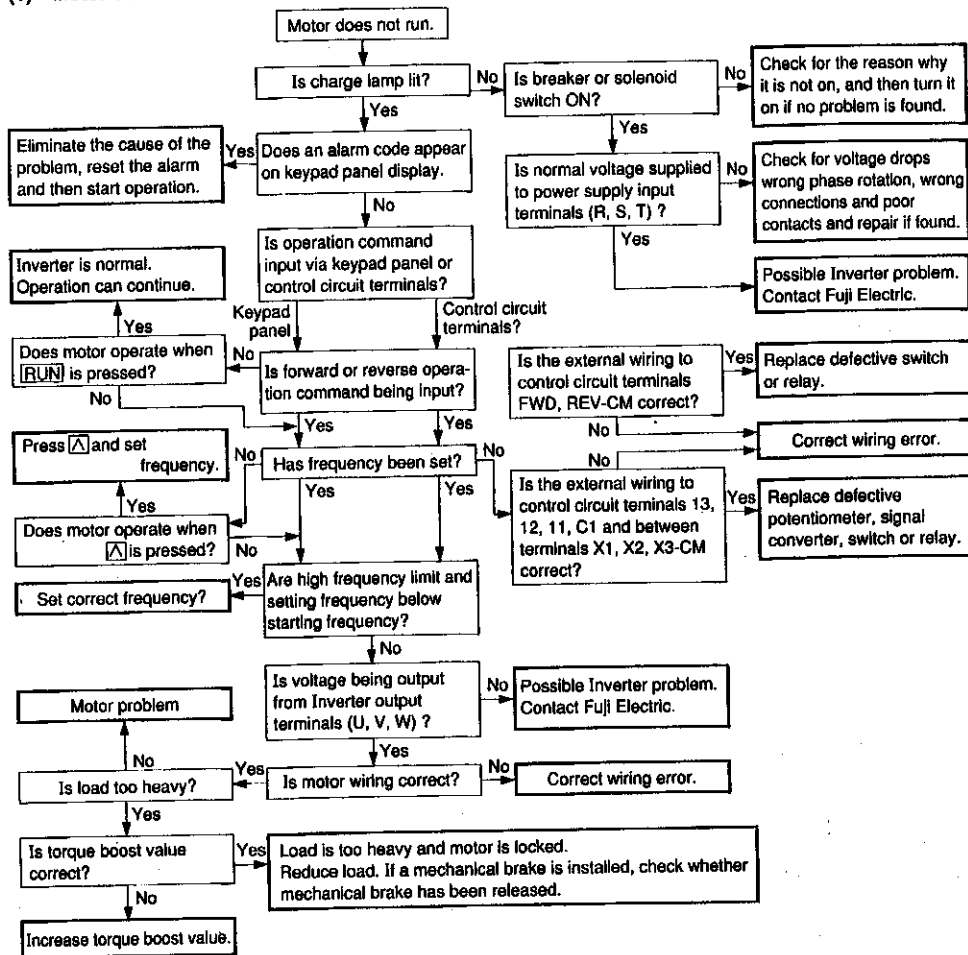

(2) Motor overheats

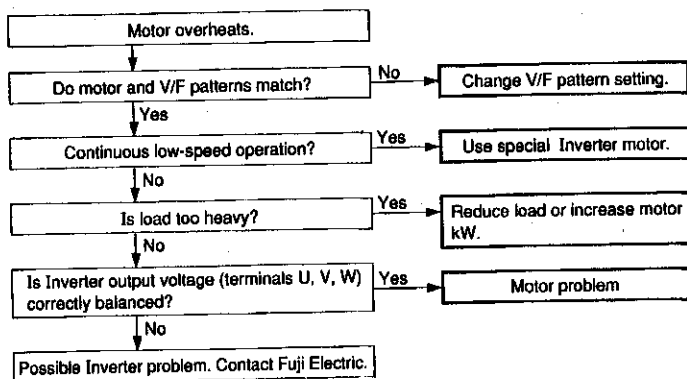

14. Standard Specifications

(1) Three-phase 200V system specifications

Inverter model		FVR0.1 E9S-2(JE)	FVR0.2 E9S-2(JE)	FVR0.4 E9S-2(JE)	FVR0.75 E9S-2(JE)	FVR1.5 E9S-2(JE)	FVR2.2 E9S-2(JE)	FVR3.7 E9S-2(JE)	
Nominal applied motor ¹⁾ [kW]		0.1	0.2	0.4	0.75	1.5	2.2	3.7	
Rated capacity ²⁾ [kVA]		0.3	0.57	1.1	1.9	3.0	4.2	6.5	
Rated output		Voltage [V] 200 to 230V, 50/60Hz							
Output current [A]	At low carrier ³⁾	0.8	1.5	3.0	5.0	8.0	11.0	17.0	
	Standard ⁴⁾	0.7	1.3	2.5	4.0	7.0	10.0	16.5	
Overload capacity		150% 1minute, 200% 0.5s							
Rated frequency [Hz]		50/60Hz							
Input power		Phase, voltage and frequency Three-phase, 200 to 230V, 50/60Hz							
Allowable variation		Voltage: +10 to -15% (voltage imbalance within 3% ⁵⁾), Frequency: ±5%							
Capability for voltage dips [kVA]		165V or more for continuous operation, less than 165V for 15ms continuous operation ⁶⁾							
Required power capacity ⁷⁾ [kVA]		0.3	0.7	1.2	1.8	3.2	4.5	7.3	
Braking torque ⁸⁾ [%]		100% or more		70% or more		40% or more			
		---		150% or more		100% or more			
DC injection brake		Brake starting frequency : 0.2 to 60Hz, braking time 0.01 to 30s, braking torque : 0 to 100%, setting resolution 1%							
Protective structure		Totally enclosed type (IP40)							
Cooling method		Natural cooling				Fan cooling			
Mass [kg]		0.9	1.0	1.2	1.4	2.0	2.7	3.2	

(2) Three-phase 400V system specifications

Inverter model		FVR0.4E9S-4 (JE)	FVR0.75E9S-4 (JE)	FVR1.5E9S-4 (JE)	FVR2.2E9S-4 (JE)	FVR3.7E9S-4 (JE)	
Nominal applied motor ¹⁾ [kW]		0.4	0.75	1.5	2.2	3.7	
Rated capacity ²⁾ [kVA]		1.2	1.9	2.8	4.2	6.9	
Rated output		Voltage [V] 380 to 480V, 50/60Hz					
Output current [A]	At low carrier ³⁾	1.6	2.5	3.7	5.5	9.0	
	Standard ⁴⁾	1.4	2.1	3.7	5.3	8.7	
Overload capacity		150% 1 min., 200% 0.5s					
Rated frequency [Hz]		50/60Hz					
Input power		Phase, Voltage and frequency Three-phase, 380 to 480V, 50/60Hz					
Allowable variation		Voltage:+10 to -15% (voltage imbalance within 3% ⁵⁾), Frequency: ±5%					
Capability for voltage dips [kVA]		310V or more for continuous operation, less than 310V for 15ms continuous operation ⁶⁾					
Required power capacity ⁷⁾ [kVA]		0.7	1.2	2.2	3.1	5.0	
Braking torque ⁸⁾ [%]		100% or more		50% or more			
		150% or more		100% or more			
DC injection brake		Brake starting frequency: 0.2 to 60Hz, braking time 0.01 to 30s, braking torque 0 to 100%, resolution 1%					
Protective structure		Totally enclosed type (IP40)					
Cooling method		Natural cooling			Fan cooling		
Mass [kg]		1.8	1.8	2.7	2.7	3.2	

(3) Single-phase 200V system specifications

Inverter model		FVR0.1E9S -7(JE)	FVR0.2E9S -7(JE)	FVR0.4E9S -7(JE)	FVR0.75E9S -7(JE)	FVR1.5E9S -7(JE)	FVR2.2E9S -7(JE)
Nominal applied motor ¹⁾ [kW]		0.1	0.2	0.4	0.75	1.5	2.2
Rated capacity ²⁾ [kVA]		0.3	0.57	1.1	1.9	3.0	4.2
Rated output	Voltage [V]	200 to 230V, 50/60Hz					
	Output current [A]	At low carrier ³⁾ 0.8, 1.5, 3.0, 5.0, 8.0, 11.0 Standard ⁴⁾ 0.7, 1.3, 2.5, 4.0, 7.0, 10.0					
	Overload capacity	150% 1min., 200% 0.5s					
Rated frequency [Hz]		50/60Hz					
Input power	Phase, voltage and frequency	Single-phase, 200 to 240V, 50/60Hz					
	Allowable variation	Voltage: +10 to -10%, Frequency: ±5%					
	Capability for voltage dips [kVA]	165V or more for continuous operation, less than 165V for 15ms continuous operation ⁶⁾					
Required power capacity ⁷⁾ [kVA]		0.3	0.7	1.2	1.8	3.2	4.5
Braking	Braking torque ⁸⁾ [%]	100% or more		70% or more		40% or more	
	Braking torque ⁹⁾ [%]	—		150% or more		100% or more	
	DC Injection brake	Brake starting frequency: 0.2~60Hz, braking time 0.01~30s, braking torque 0~100%, resolution 1%					
Protective structure		Totally enclosed type (IP40)					
Cooling method		Natural cooling				Fan cooling	
Mass [kg]		1.0	1.1	1.6	1.7	2.7	2.8

¹⁾ "Nominal applied motor" refers to a standard 4-pole motor.

²⁾ Indicates rated capacity when rated output voltage is 230V or 400V

³⁾ When $\overline{F112}$ (motor operating sound adjustment) = $\overline{0}$ to $\overline{3}$

⁴⁾ When $\overline{F112}$ (motor operating sound adjustment) = $\overline{4}$ to $\overline{5}$

⁵⁾ If the voltage imbalance is greater than 3%, use a power factor improving AC reactor.

$$\text{Voltage imbalance [\%]} = \frac{\text{Maximum voltage [V]} - \text{Minimum voltage [V]}}{\text{Average 3-phase voltage [V]}} \times 100$$

⁶⁾ When a momentary power failure occurs under nominal voltage input and 85% load

⁷⁾ When running a standard motor with an ACR (option) attached to the input side

⁸⁾ This is the average braking torque for the motor itself. (Varies according to the motor efficiency.)

⁹⁾ When using an external braking resistor. However, 0.1kW and 0.2kW types do not have a built-in brake circuit, so an external braking resistor cannot be used.

(4) Common specifications

Item		Specifications	
Output frequency	Adjustment	Maximum frequency [Hz]	Adjustable between 50 to 400Hz
		Base frequency [Hz]	Adjustable between 15 to 400Hz
		Starting frequency [Hz]	Adjustable between 0.2 to 15Hz (in steps of 1Hz between 1 to 15Hz)
		Carrier frequency [Hz]	Adjustable between 0.75 to 15kHz (in steps of 1kHz between 1 to 15kHz)
	Accuracy	Analog : $\pm 0.2\%$ of maximum frequency (at $\pm 25^{\circ}\text{C}$) Digital : $\pm 0.01\%$ of maximum frequency (at $\pm 25^{\circ}\text{C}$)	
	Setting resolution	Analog : 1/3000th of maximum frequency (at 0.02Hz/60Hz, at 0.04Hz/120Hz, and at 0.1Hz/300Hz) Digital : 0.01Hz (0.00 to 99.99Hz), 0.1Hz (100.0 to 400.0Hz)	
Control method	Sinusoidal PWM control (ultra-low noise due to high-frequency carrier)		
Operation method	Key operation : Run and Stop using RUN and STOP keys Potentiometer : Equipped with 1 to 5k Ω potentiometer terminals Input signals : Forward/reverse command, coast-to-stop command, reset input, acc./dec. time switching, multistep frequency selection, 3-wire operation, etc.		
Frequency setting	Key operation : Δ and ∇ keys Potentiometer : Equipped with 1 to 5 k Ω potentiometer terminals Analog input : DC 0 to 5V, DC 0 to 10V, DC 1 to 5V ($Z_{in} = 22\text{k}\Omega$), DC 4 to 20mA ($Z_{in} = 250\Omega$) setting possible Multistep frequency : Max. 16 different frequencies can be selected through combination of 4 external signals Digital signal : Setting by "12-bit parallel" or serial communication possible with optional card		
Control	Running status signal	Open collector output : RUN, FAR, FDT, OL, LV, IP Analog output : Output frequency, output current, output torque, load factor Pulse output : Output frequency	
	Indication	RUN or STOP mode	Output frequency, output current, output voltage, motor synchronous speed, line speed [Hz] [A] [V] [r/min.] [m/min.]
		Setting mode	Function code and data. LED lights at voltage charged.
		Trip mode	Indications of trip cause (4-digit code)
Acceleration time Deceleration time	0.1 to 3600s : Independently adjustable acceleration and deceleration, 2 sets of data selectable Linear and non-linear (2 S-curve patterns) acceleration and deceleration selectable		
V/F characteristics	Output voltage to 2 output frequency ratios are adjustable (Switchable base frequency by external input.)		
Torque boost	Automatic : Adjusted to optimum setting according to load torque (Auto tuning of motor constants possible) Manual : Variable setting possible in 31 steps (Squared and proportional torque patterns, etc. available)		

	Item	Specifications
Control	Starting torque [%]	150% (at 1Hz), 200% (at 3Hz) with the Torque Vector Control.
	Restart after momentary power failure	Inverter restarts automatically without the motor stopping when automatic restart set.
	Frequency limiter	High frequency limit and low frequency limit can be set.
	Bias frequency	Frequency corresponding to 0 of frequency setting signal (bias frequency) adjustable within the range -400 to $+400$ Hz in steps of 1Hz.
	Gain for frequency setting	Adjustable to 0 to 250% in proportion to analog frequency setting signal and output frequency.
	Frequency jump control	The jumping frequency (3 points) and jumping hysteresis (1 point) can be set.
	Slip compensation	To keep the motor speed stable, the Inverter output frequency is compensated according to load torque.
Protection	Torque limiting control [%]	Control the Inverter output below a preset level (% value...set to torque in constant torque range, and to load factor in constant output range).
	Overload	Inverter stops when overload current is detected.
	Overvoltage	Inverter stops when overvoltage detected in DC link circuit (200V systems : DC 400V, 400V systems : DC 800V)
	Surge input	Inverter protection from surge input which is applied at main power supply lines or between main power supply lines and ground.
	Undervoltage	Inverter stops when overvoltage detected in DC link circuit
	Overheating	Inverter stops when abnormally high temperature detected in cooling unit.
	Short circuit	Inverter protected against overcurrent from a short circuit at the output side.
	Grounding fault	Inverter protected against overcurrent from a grounding fault at the output side (protection at start).
	Motor overheating	The electronic thermal overload relay can be selected for 4-pole standard motor or Fuji FV motor (Available 2 patterns including for No. 2 motor).
	Stall prevention	Operates if output current exceeds limit during acceleration, deceleration and constant-speed operation to prevent trips due to overcurrent.
	Alarm output	Contact signal output during protective trip (1c contact, contact rating : AC 250V, 0.3A, $\cos \phi = 0.3$)
	Environment	Installation location
Ambient temperature		-10 to $+50^{\circ}\text{C}$ (Remove the ventilation covers when the temperature exceeds $+40^{\circ}\text{C}$)
Ambient humidity		20 to 95% RH (non-condensing)
Vibration		5.9m/s^2 (0.6G) or less
	Storage temperature	-25 to $+65^{\circ}\text{C}$

15. External dimensions

FVR0.1 to 0.75E9S-2/2JE

FVR0.1/0.2E9S-7/7JE

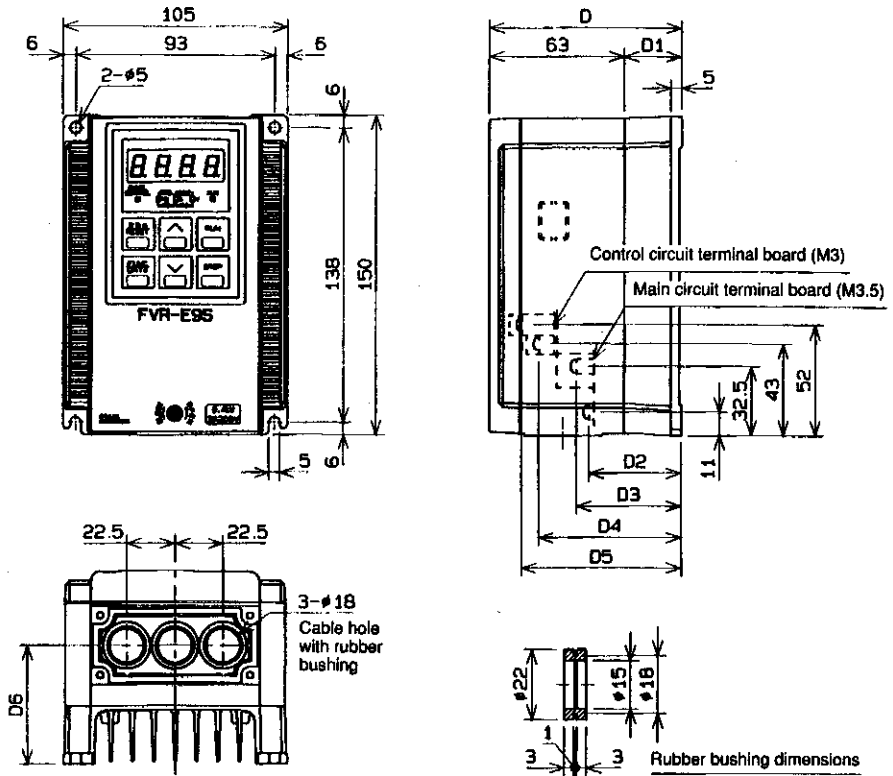

unit [mm]

Input voltage	Model	D	D1	D2	D3	D4	D5	D6
3-phase 200V	FVR0.1E9S-2/2JE	72	9	25	31	49	57	37.5
	FVR0.2E9S-2/2JE	80	17	33	39	57	65	45.5
	FVR0.4E9S-2/2JE	90	27	43	49	67	75	55.5
	FVR0.75E9S-2/2JE	119	56	72	78	96	104	84.5
Single phase 200V	FVR0.1E9S-7/7JE	72	9	25	31	49	57	37.5
	FVR0.2E9S-7/7JE	80	17	33	39	57	65	45.5

FVR1.5E9S-2
FVR1.5E9S-2JE

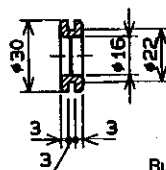
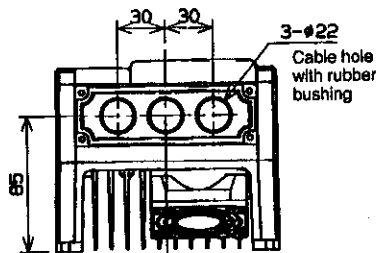
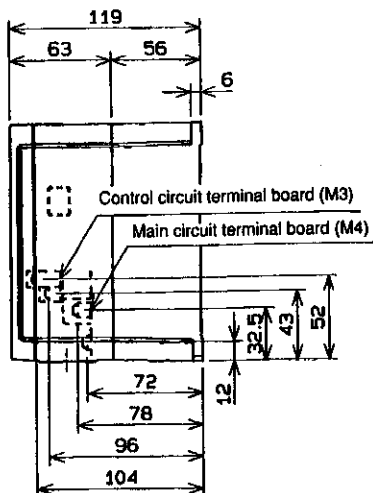
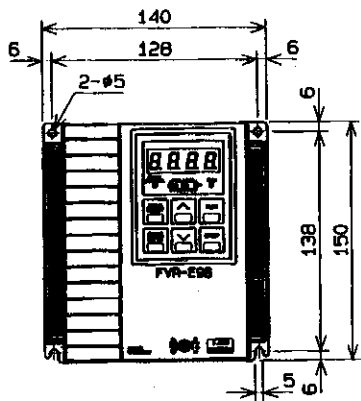

Rubber bushing dimensions

FVR 2.2 / 3.7 E 9 S - 2 / 2 J E
 FVR 1.5 to 3.7 E 9 S - 4 / 4 J E
 FVR 1.5 / 2.2 E 9 S - 7 / 7 J E

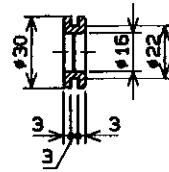
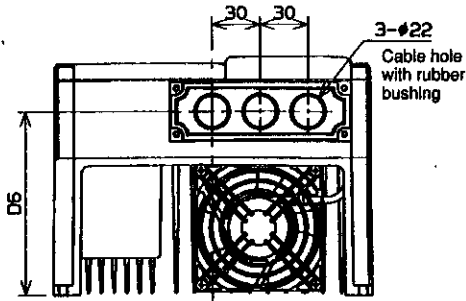
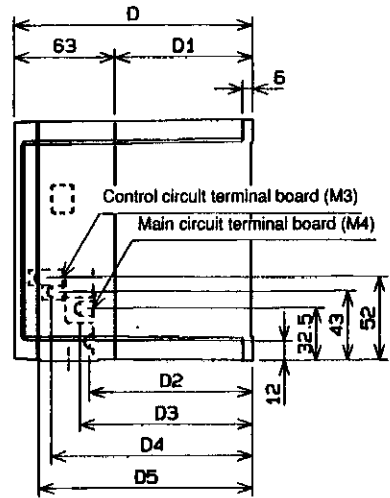
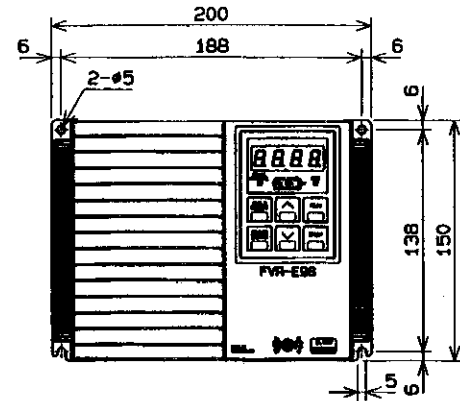

Rubber bushing dimensions

		unit [mm]						
Input voltage	Model	D	D1	D2	D3	D4	D5	D6
3-phase 200V	FVR2.2E9S-2/2JE	134	71	87	93	111	119	100
	FVR3.7E9S-2/2JE	149	86	102	108	126	134	115
3-phase 400V	FVR1.5E9S-4/4JE	134	71	87	93	111	119	100
	FVR2.2E9S-4/4JE	134	71	87	93	111	119	100
Single phase 200V	FVR3.7E9S-4/4JE	149	86	102	108	126	134	115
	FVR1.5E9S-7/7JE	134	71	87	93	111	119	100
	FVR2.2E9S-7/7JE	134	71	87	93	111	119	100

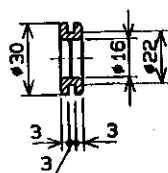
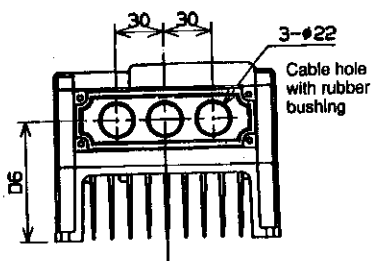
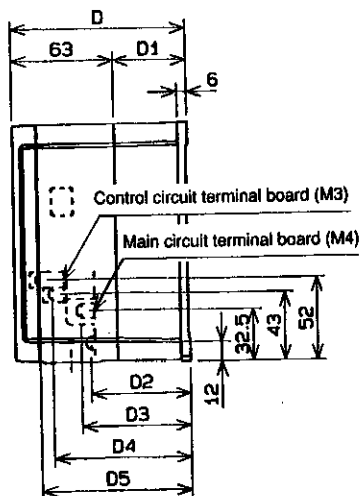
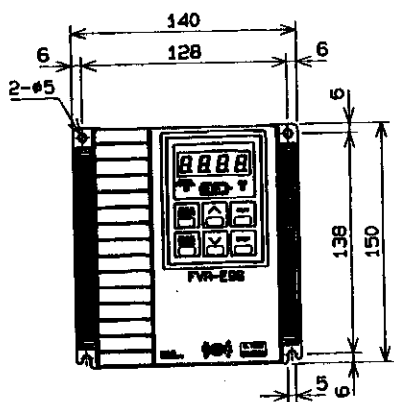

Rubber bushing dimensions

unit [mm]

Input voltage	Model	D	D1	D2	D3	D4	D5	D6
3-phase 400V	FVR0.4E9S-4/4JE	109	46	62	68	86	94	75
	FVR0.75E9S-4/4JE	109	46	62	68	86	94	75
Single phase 200V	FVR0.4E9S-7/7JE	109	46	62	68	86	94	75
	FVR0.75E9S-7/7JE	109	46	62	68	86	94	75

16. Optional equipment

Breaker	Connect a breaker (MCCB) in order to protect the main Inverter circuits and also to turn the power supply on and off. Rated current values and rated breaker capacities vary according to the power supply specifications.
Magnet contactor	The Inverter can be operated even without a magnetic contactor connected. However, it can be connected in order to turn off the power for safety reasons when the Inverter protective function operates.
Surge absorber	Connect in order to absorb any surges which may occur when magnetizing coils such as magnetic contactors and control relays open and close.
Radio noise suppression reactor	Use in order to reduce electromagnetic noise which interferes with radios other electrical equipment near the Inverter.
Power factor improving DC reactor (for harmonics reduction)	Connect in order to improve the Inverter input power factor. The power factor will be improved to around 0.90 — 0.95. It is also effective in reducing harmonics currents.
Matching reactor (AC reactor)	<p>Connect in the following cases.</p> <p>① When the power supply transformer is 500kVA or higher.</p> <p>② When there is a thyristor load on the same power supply system with the Inverter, or if a power factor improving capacitor is being turned on and off.</p> <p>③ If there is 3% or more of imbalance in the power supply voltage.</p> <p>Voltage imbalance [%]</p> $= \frac{\text{Maximum voltage [V]} - \text{Minimum voltage [V]}}{\text{Average of 3-phase voltage [V]}} \times 100$ <p>④ To provide an improved input power factor. The power factor will be improved to 0.75~0.85.</p>
Braking resistor	Connect when a large amount of braking torque is required.
Frequency setting potentiometer	Connect when using the power supply from the control circuit terminals in order to set the frequency.
Keypad panel extension cable	Use when removing the keypad panel from the Inverter, and installing it to a control board, etc.

■ Applicable equipment and wire sizes for main circuit ¹⁾

Voltage	Applicable motor [kW]	Inverter type	Recommended wire size [mm ²]					MCCB, ELCB ³⁾ current rating [A]		Fuse [A]	Fuji magnetic contactor	Spark killer	
			R, S, T ²⁾	U, V, W	P ₁ , P ₂ , P ₃	P(+), DB	E(G)	Control	with DCR				without DCR
Three phase 200V system	0.1	FVR0.1E9S-2/2JE											SA-A-O (for magnetic contactor)
	0.2	FVR0.2E9S-2/2JE											
	0.4	FVR0.4E9S-2/2JE	2.0	2.0	2.0								
	0.75	FVR0.75E9S-2/2JE				2.0							
	1.5	FVR1.5E9S-2/2JE	3.5										
	2.2	FVR2.2E9S-2/2JE	5.5	3.5	3.5								
Three phase 400V system	0.4	FVR0.4E9S-4/4JE							2.0	0.2			S1-B-O (for mini-control relay timer)
	0.75	FVR0.75E9S-4/4JE								~			
	1.5	FVR1.5E9S-4/4JE	2.0	2.0	2.0	2.0				1.25			
	2.2	FVR2.2E9S-4/4JE											
	3.7	FVR3.7E9S-4/4JE	5.5										
	5.5	FVR5.5E9S-4/4JE	10										
Single phase 200V system	0.1	FVR0.1E9S-7/7JE											SC-05
	0.2	FVR0.2E9S-7/7JE											
	0.4	FVR0.4E9S-7/7JE	2.0	2.0	2.0								
	0.75	FVR0.75E9S-7/7JE											
	1.5	FVR1.5E9S-7/7JE	3.5	2.0	2.0	2.0							
	2.2	FVR2.2E9S-7/7JE	5.5										

¹⁾ The above table is based on data for a Fuji standard motor.

²⁾ The single phase series are not provided with S-terminal.

³⁾ MCCB and ELCB types vary depending on the shorting capacity of the equipment. Refer to a breaker catalog for help in selecting.

⁴⁾ Use a fuse for which $I^2t \geq 150 [A^2s]$.

⁵⁾ Use a fuse for which $I^2t \geq 120 [A^2s]$.

17. Attention to prevent from failure

Make sure to carry out the following items to use the inverters without failure for a long term.

1. Provide an AC reactor on the power supply side in the following cases:
 - (1) The power supply capacity (transformer capacity) exceeds 500kVA.
 - (2) The primary voltage of the power supply transformer exceeds 6.6kV.
 - (3) A thyristor converter is connected to the same power supply system.
 - (4) A power factor correction capacitors are connected to the same power supply system.
 - (5) An arc welder is used in the same power supply system.
 - (6) Unbalance of three phase power supply voltages exceeds 3%.
Unbalance of power supply voltages = $\frac{\{\text{Max. voltage} - \text{Min. voltage}\}}{\text{Mean three phase voltage}} \times 100\%$
 - (7) The wiring length between the inverter and motor exceeds 100m
2. Use the inverter in the range not exceeding the permissible voltage.
When voltage may exceed the permissible voltage, decrease the voltage with a transformer or cut off with an overvoltage relay.
3. Do not use the inverter in the open-phase state of the three phase power supply.
4. Do not use the motor of poor insulation.
5. Take cares the following items for installation of the inverter:
 - (1) Install the inverter where there are no dust, vibration, temperature rise by direct sunlight and water drop or vapor.
 - (2) Keep the ambient temperature within the rated temperature range.
Further, install the inverter so that the generating heat of the inverter itself does not heat the surrounding.
6. Suppress noise generation by providing spark killers to relays and solenoids installed near the inverter.
7. Use the genuine Fuji Electric optional devices such as DB resistors and AC reactors.
8. Take cares the following items for wiring:
 - (1) Make sure sufficiently that there is incorrect wiring before connecting the power supply.
Further, make sure sufficiently that the screws on the terminal block are not loose.
 - (2) Use shielded wire or twisted wire according to the instruction manual.
Further, connect the shield sheath of the shielded wire according to the instruction manual.
 - (3) Do not bundle together the wires connected to the control circuit terminal block and the wires connected to the main circuit terminal block, or do not put together them in the same wiring duct.
 - (4) Ground the inverter surely.
 - (5) Do not connect capacitors such as phase advancer capacitor directly to the output terminals of the inverter.
9. Start and stop the inverter operation with the keypad panel or FWD and REV.
Do not frequently start and stop by switching the power supply ON/OFF or do not make ON/OFF on the output side of the inverter.
10. Perform megger according to the instruction manual.
Further, do not disconnect the wiring remaining in operation in maintenance and inspection.
11. When transporting or storing the inverter, prevent from shock or fall, large vibration, high temperature and high humidity, and keep the permissible number of the piling up stages of packages.

18. Optional equipment (Chinese)

< 任选与外部设备 >

断路器	为了保护变频器的主电路和对电源进行开关，要连接布线用断路器（MCCB）。根据电源的技术要求数据，来改变额定电流值和额定断路容量。
电磁接触器	即使不连接电磁接触器；变频器也能运转，当变频器保护功能动作时，为了安全，以断开电源等作为目的时连接电磁接触器。
电涌吸收器	为了吸收电磁接触器、控制继电器等励磁线圈开关时所产生的电涌，连接电涌吸收器。
降低无线电噪声的电抗器	噪声障碍波及到变频器周围的无线电、电子仪器时，作为降低噪声的措施，可使用这种电抗器。
改善功率因数的直流电抗器（DC电抗器）	为了改善变频器输入功率因数，可连接这种电抗器。功率因数被改善为0.90-0.95。
电源协调用交流电抗器（AC电抗器）	<p>在下述情况下连接。</p> <p>① 电源变压器500KVA以上时</p> <p>② 同一电源上有可控硅负载时或开关控制改善功率因数的电容器时</p> <p>③ 电源电压有3%以上的非平衡时</p> $\text{电源电压非平衡率}[\%] = \frac{\text{最大电压}[\text{V}] - \text{最小电压}[\text{V}]}{\text{三相平均电压}[\text{V}]} \times 100\%$ <p>④ 谋求输入功率因数的改善时 功率因数被改善为0.75-0.85</p>
制动单元 阻尼电阻器	在需要大的制动转矩时连接。
频率设定器	由控制电路端子利用变频器的电源，设定频率时连接这种设定器。
触摸面板延长电缆	从变频器上卸下触摸面板，安装到盘面上时使用这种电缆。

19. Attention to prevent from failure (Chinese)

< 为防止故障的注意 >

为使变频器能长时间使用而不发生故障，请按照以下内容确实进行实施。

1. 以下情况下请在变频器的电源侧设置AC电容器。
 - ①电源的容量（变压器的容量）在500KVA以上时
 - ②电源变压器的初级侧电压超过6.6KV时
 - ③在同一电源系统连接晶闸管变换器时
 - ④在同一电源系统连接改善功率用电容器时
 - ⑤在同一电源系统使用电弧焊机时
 - ⑥三相电源电压的不平衡超过3%时
电源电压的不平衡 (%) = [(最大电压 - 最小电压) / 三相平均电压] × 100%
 - ⑦变频器与电动机之间布线的长度超过100m时
2. 电源电压请在允许值范围内使用。
在可能要超过允许值的情况下，请用变压器将电压降低或用电压继电器进行切断等。
3. 三相电源的一相有欠缺状态时请不要使用。
4. 请不要使用绝缘不良的电动机。
5. 设置场所请注意以下几点。
 - ①请在无垃圾、灰尘、无振动、及避开因阳光照射使温度上升、无水滴、水蒸气的地方设置。
 - ②周围温度请控制在额定的温度范围内。
另外，请避免因变频器本身发热而使周围充满热气来进行设置。
6. 请在变频器附近设置的继电器、螺线管上安装火花控制器以控制噪声的发生。
7. DB电阻及AC电抗器等的选择件请使用富士电机制的产品。
8. 布线时请注意以下几点。
 - ①在开电源前请充分确认有无布线错误。另外确认端子座的螺钉有无松动。
 - ②请按照使用说明书使用屏蔽线及绞合线。
另外，屏蔽线的外表屏蔽也请按照使用说明书进行连接。
 - ③请不要将主电路端子座的布线与控制电路端子座的布线一起捆扎或放入同一个管道。
 - ④请确实进行接地。
 - ⑤变频器的输出侧请不要直接连接电容器（进相电容器等）。
9. 操作的起动·停止请用触摸面板或端子的FWD及REV进行。
请不要进行电源ON/OFF的频繁起动、停止、及变频器输出侧的ON/OFF。
10. 维修·检查时的高阻测试请按照使用说明书进行。
另外，维修检查时请不要在运转中将布线取掉。
11. 运送及保管时请避免撞击、跌落、大振动、避开高温高湿、遵守捆包的容许堆放层数。